

43314XXX / 43214XXX / 43219XXX

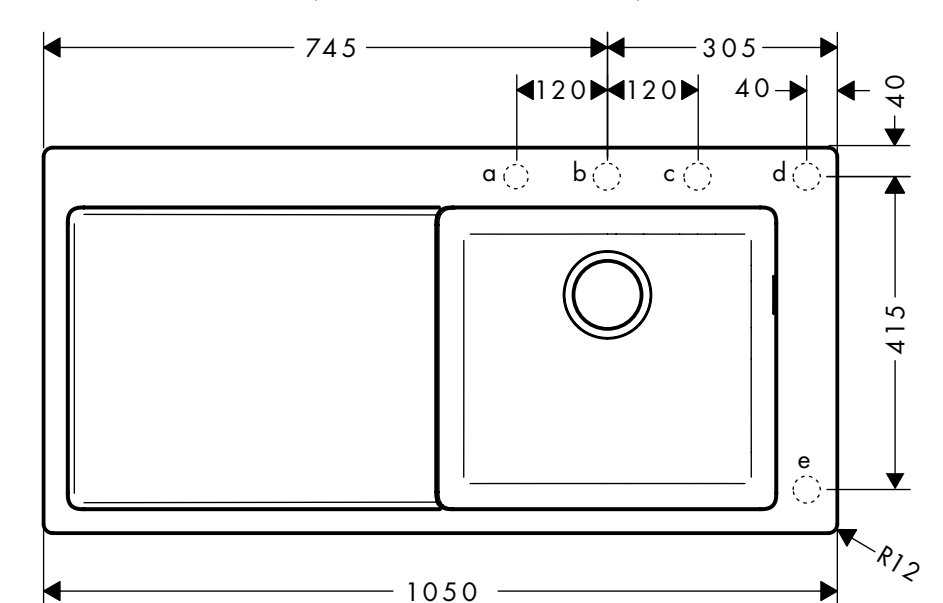

a, b, c, d, e = Ø 35

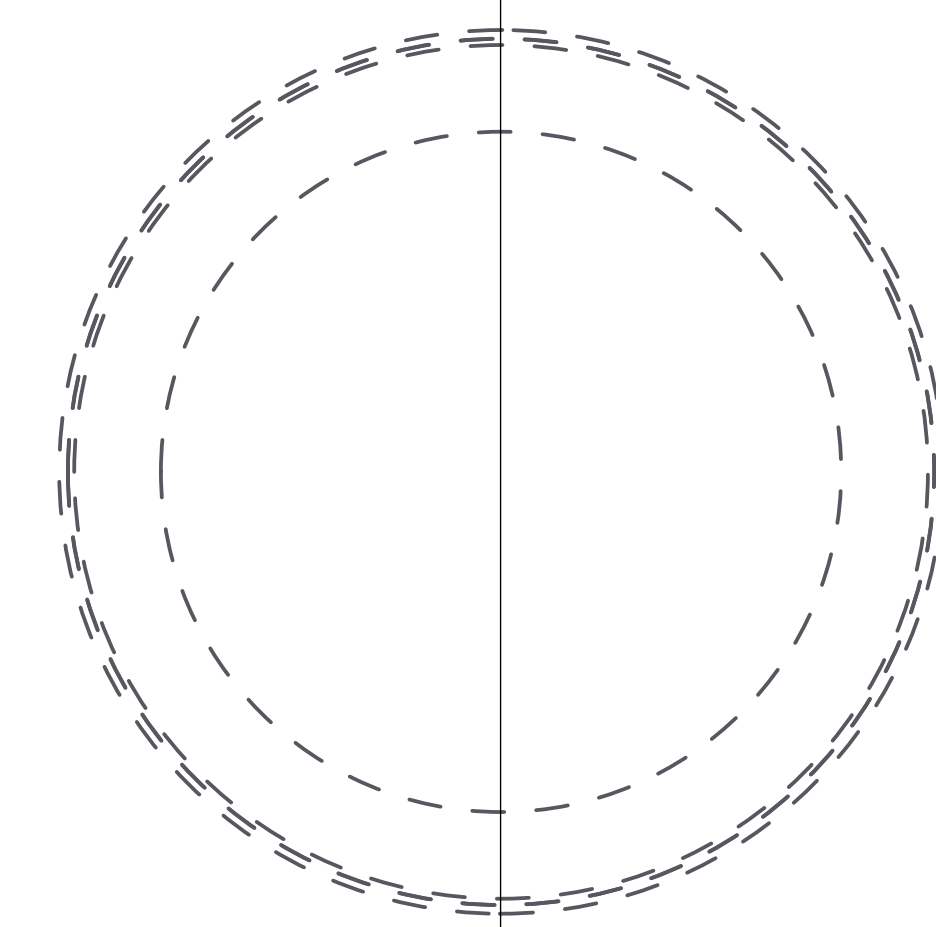
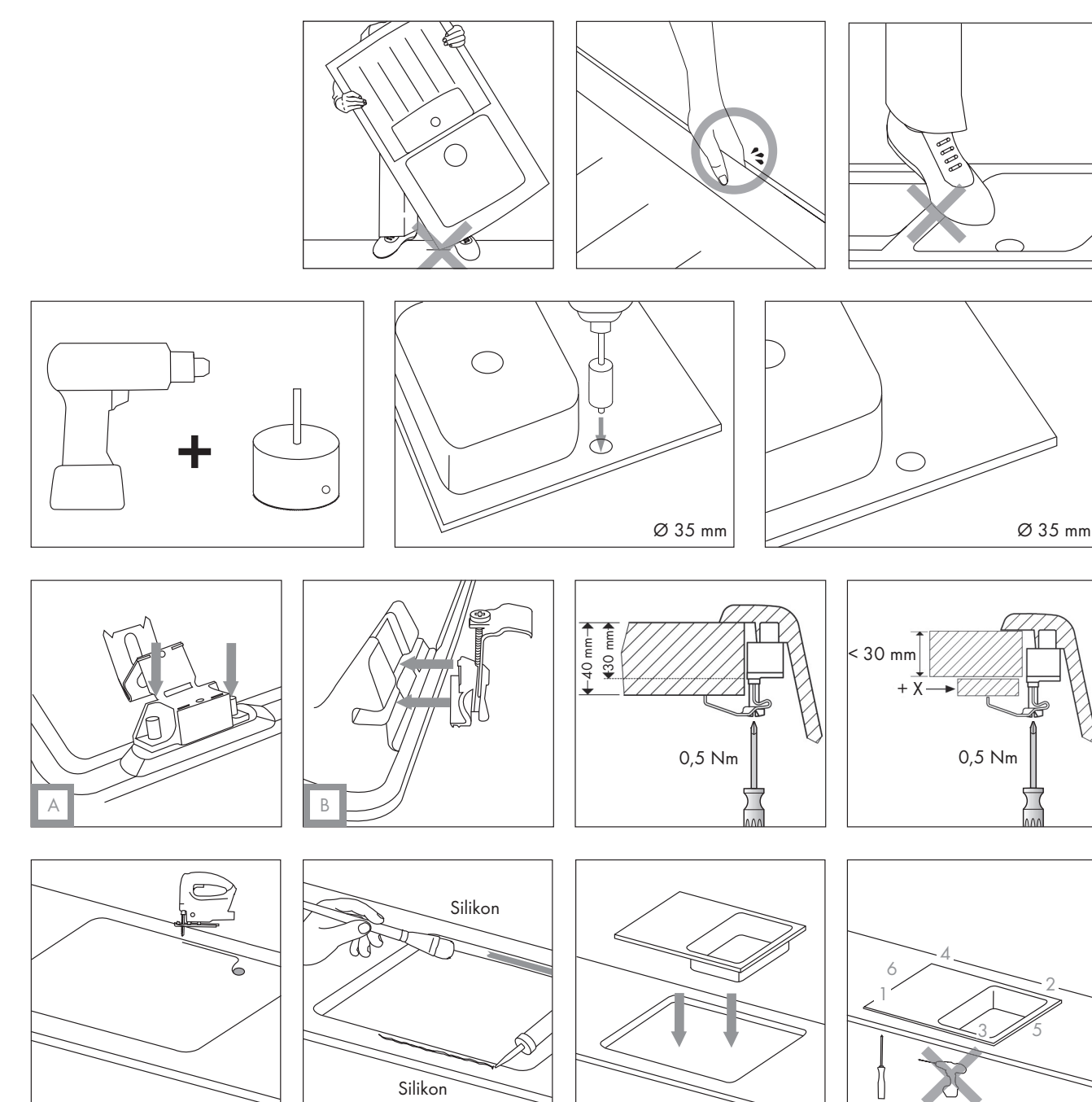
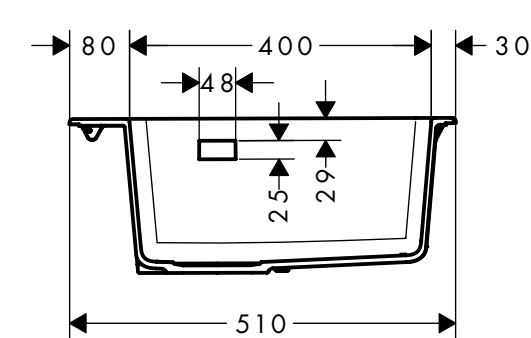
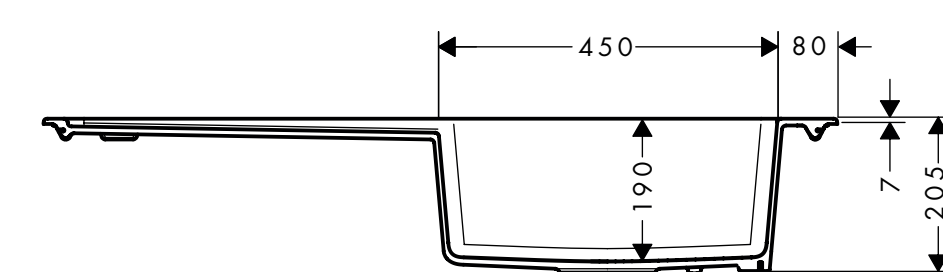

490

1030

R 10