

43313XXX / 43213XXX / 43218XXX

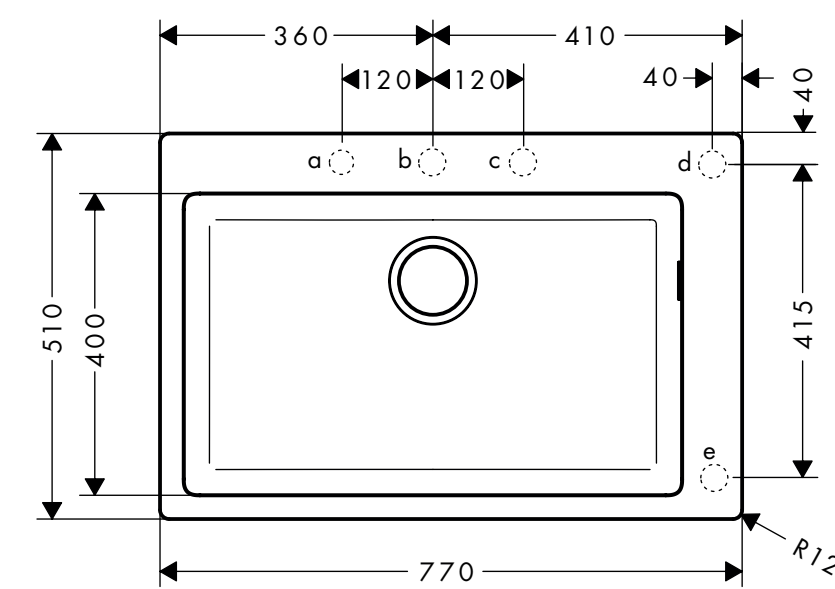

a, b, c, d, e = Ø 35

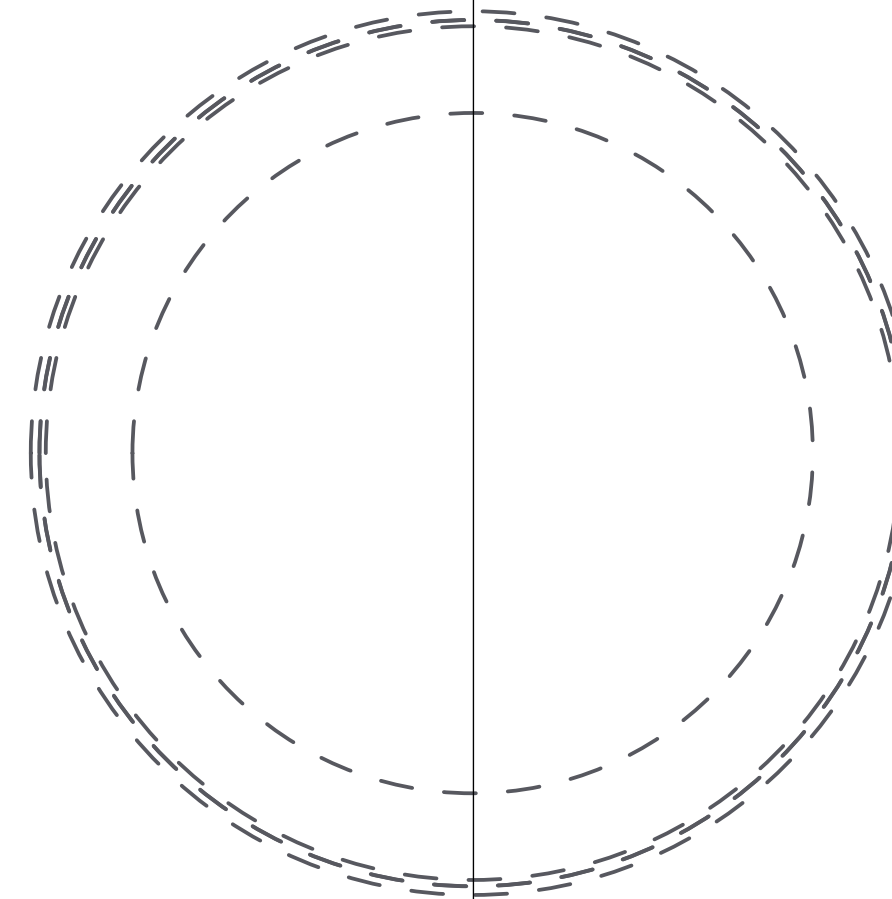
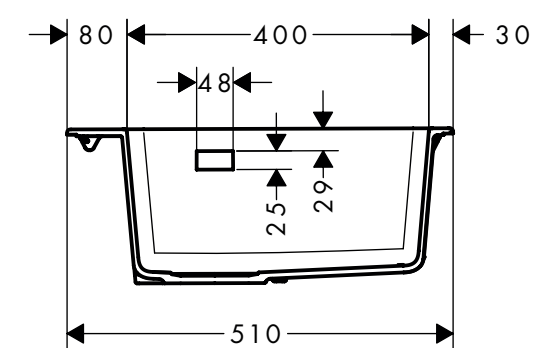
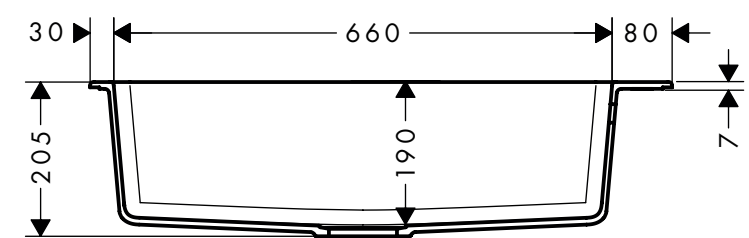

490

750

R10

