

**9621247**

4,4x 5,2W LED  
Incl. 4,4x LED Board: L9001755  
230V ~ 50Hz



**(DE) Bestimmungsgemäße Verwendung**

(GB) Intended use / (FR) Utilisation conforme / (NL) Beoogd gebruik / (PL) Stosowanie zgodnie z przeznaczeniem /  
(NO) Riktig bruk / (DK) Korrekt brug / (SE) Avsedd användning / (FI) Määräystenmukainen käyttö  
(IT) Impiego appropriato / (ES) Uso prescrito / (CZ) Použití v souladu s určením / (PT) Utilização correta / (GR) Ενδεδειγμένη χρήση

<b>(DE)</b> Ortsfeste Verwendung als Hängeleuchte im Innenbereich	<b>(GB)</b> Provided for stationary indoor use as pendant light
<b>(FR)</b> Utilisation stationnaire en tant que suspension d'intérieur	<b>(NL)</b> Vast gebruik als hanglamp binnenshuis
<b>(PL)</b> Do montażu stacjonarnego jako lampa wisząca do wnętrza	<b>(NO)</b> Til stasjonært bruk som pendellampe innendørs
<b>(DK)</b> Til stationær brug som pendellampe indendørs	<b>(SE)</b> Används som fast hänglampa inomhus
<b>(FI)</b> Kiinteä käyttö sisätilojen riippuväläisimena	<b>(IT)</b> Impiego fisso come lampada a sospensione in ambienti interni
<b>(ES)</b> Empleo fijo en tanto lámpara colgante en interiores	<b>(CZ)</b> Stacionární použití jako závěsné svítidlo v interiéru
<b>(PT)</b> Aplicação fixa como candeeiro suspenso em interiores	<b>(GR)</b> Σταθερή χρήση ως κρεμαστό φωτιστικό σε εσωτερικό χώρο

**(DE) Verwendete Symbole**

(GB) Safety Precautions / (FR) Symboles utilises / (NL) Gebruikte symbolen / (PL) Stosowane symbole / (NO) Brukte symboler /  
(DK) Brugte symboler / (SE) Använda symboler / (FI) Käytetyt symbolit / (IT) Simboli usati / (ES) Símbolos empleados /  
(CZ) Použité symboly / (PT) Símbolos utilizados / (GR) Χρησιμοποιούμενα σύμβολα

IP 20



**(DE) Lieferumfang**

(GB) Package contents / (FR) Contenu de la livraison / (NL) Bij de levering inbegrepen / (PL) Zakres dostawy / (NO) Levering /  
(DK) Leveringsomfang / (SE) Leveransomfattning / (FI) Toimitussisältö / (IT) Fornitura / (ES) Volumen de suministro /  
(CZ) Rozsah dodávky / (PT) Material fornecido / (GR) Παραδοτέος εξοπλισμός

<b>(DE)</b> 1 Hängeleuchte Montagematerial Montageanleitung	<b>(GB)</b> 1 Pendant light Installation hardware Mounting instructions	<b>(FR)</b> 1 Suspension Matériel de montage Instructions de montage
<b>(NL)</b> 1 Hanglamp Monteringsmateriale Montagehandleiding	<b>(PL)</b> 1 Lampa wisząca Elementy montażowe Instrukcja montażu	<b>(NO)</b> 1 Pendellampe Monteringsmateriale Brukerveiledning
<b>(DK)</b> 1 Pendellampe Monteringsmateriale Brugervejledning	<b>(SE)</b> 1 Hänglampa Monteringsmaterial Monteringsanvisning	<b>(FI)</b> 1 Riippuväläisin Asennusmateriaali Asennusohjeet
<b>(IT)</b> 1 Lampada a sospensione Materiale di montaggio Istruzioni di montaggio	<b>(ES)</b> 1 Lámpara colgante Material de montaje Instrucciones de montaje	<b>(CZ)</b> 1 Závěsné svítidlo Materiál pro montáž Návod k montáži
<b>(PT)</b> 1 Candeeiro suspenso Material de montagem Instruções de montagem	<b>(GR)</b> 1 Κρεμαστό φωτιστικό Υλικά συναρμολόγησης Οδηγίες συναρμολόγησης	

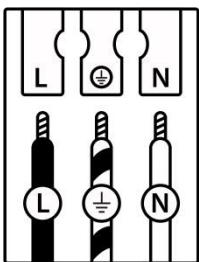
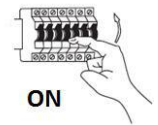
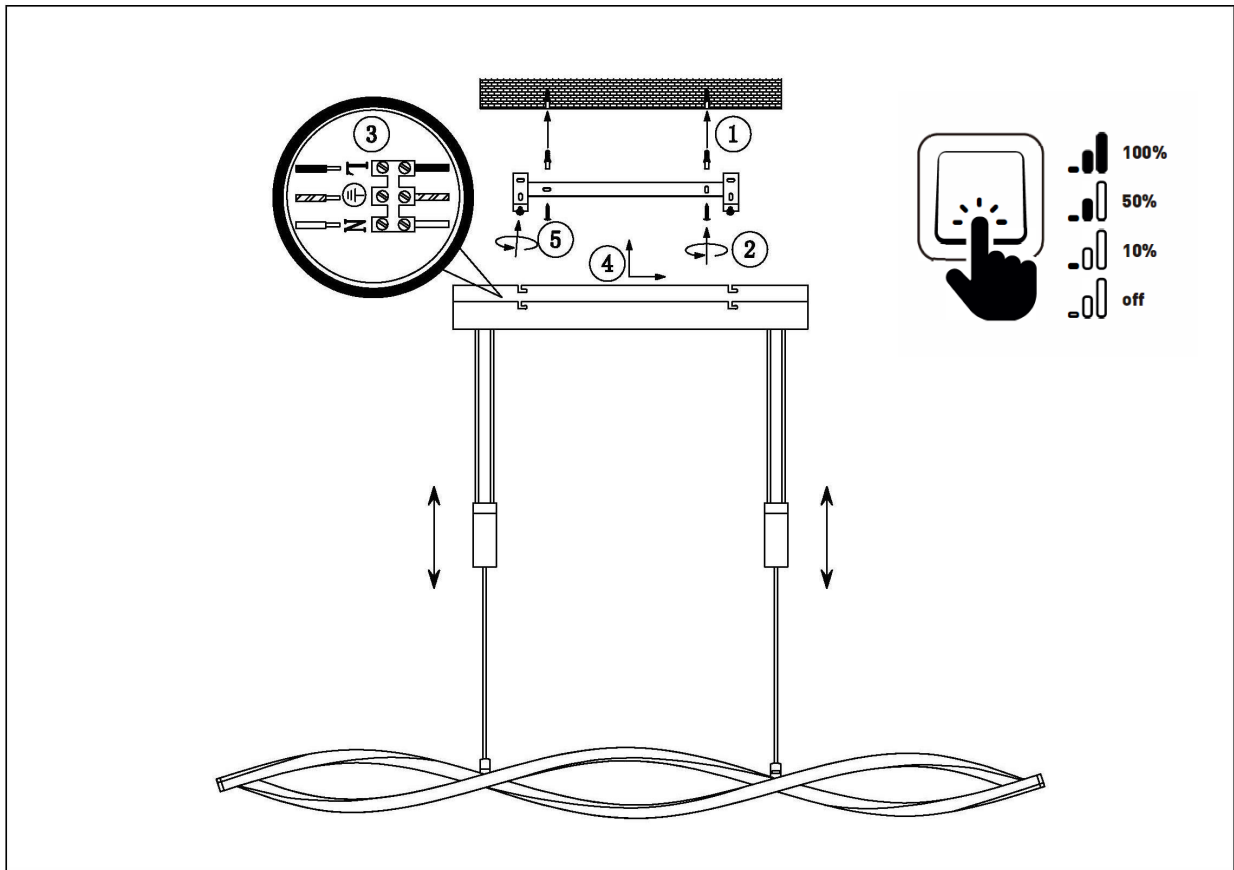
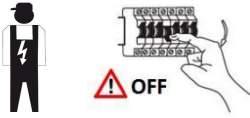

	(DE)	(GB)	(FR)	(NL)	(PL)	(NO)	(DK)
<b>L</b>	Stromführender Leiter	Live conductor	Conducteur	Spanningvoerende draad	Przewód prądowy	Strømførende leder	Strømførende leder
	Schutzleiter	Earth conductor	Conducteur de protection (terre)	Aardkabel	Przewód uziemiający	Jordledningen	Jordledningen
<b>N</b>	Neutralleiter	Neutral conductor	Conducteur neutre	Nulleider	Przewód zerowy	Nøytralleider	Neutralleider

	(SE)	(FI)	(IT)	(ES)	(CZ)	(PT)	(GR)
<b>L</b>	Strömförande ledare	Virtajohdin	Conduttore sotto tensione	Líneas conductoras de corriente	Vodič pod napětím	Condutor vivo	Ρευματοφόρος αγωγός
	Skyddsledare	Suojajohdin	Conduttore di terra	Conductor de protección	Ochranný vodič	Condutor de terra	Αγωγός γείωσης
<b>N</b>	Neutralledare	Nollajohdin	Conduttore neutro	Conductor neutro	Neutrální vodič	Condutor neutro	Ουδέτερος αγωγός

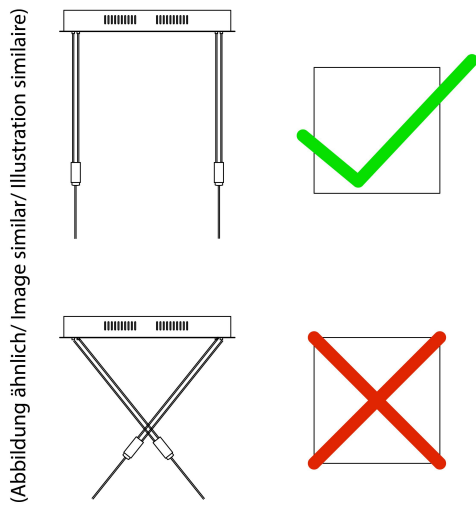

Die Drahtseile dürfen einander nicht berühren oder mit dem Leuchtenkörper/ Deckenkasten in Berührung kommen. Dies führt zu einem Kurzschluss, der die Funktion der Leuchte beeinträchtigen kann.

Leuchte nur an der Decke montiert einschalten!

The wire ropes must not touch each other or come into contact with the lamp body / ceiling box. This leads to a short circuit that can impair the function of the lamp.

Only switch on the light when the lamp is mounted on the ceiling!

Les câbles métalliques ne doivent pas se toucher ni entrer en contact avec le corps du luminaire / le boîtier de plafond. Cela conduit à un court-circuit qui peut altérer le fonctionnement de la lampe.

N'allumez la lumière que lorsque la lampe est montée au plafond!

**ACHTUNG!** Die Leuchte darf auf keinen Fall im eingeschalteten Zustand in der Höhe verstellt werden! Dies darf nur im ausgeschalteten Zustand erfolgen!

**WARNING!** The height of the lamp must never be adjusted when it is switched on! This may only be done when the lamp is switched off!

**ATTENTION!** La hauteur de la lampe ne doit jamais être ajustée lorsqu'elle est allumée! Cela ne peut être fait que lorsque la lampe est éteinte!

<p><b>(DE)</b> Dieses Produkt enthält eine Lichtquelle der Energieeffizienzklasse E  <b>(EN)</b> This product contains a light source of energy efficiency class E  <b>(FR)</b> Ce produit comprend une source de lumière de classe d'efficacité énergétique E  <b>(NL)</b> Dit product bevat een lichtbron van energie-efficiëntieklasse E  <b>(PL)</b> Produkt ten zawiera źródło światła o klasie efektywności energetycznej E  <b>(NO)</b> Dette produktet inneholder en lyskilde i energieeffektivitetsklasse E  <b>(DK)</b> Dette produkt indeholder en lyskilde af energieeffektklasse E  <b>(SE)</b> Denna produkt innehåller en ljuskälla i energieffektivitetsklass E  <b>(FI)</b> Tämä tuote sisältää energiatehokkuusluokan E valonlähteen  <b>(IT)</b> Questo prodotto contiene una sorgente luminosa della classe di efficienza energetica E  <b>(ES)</b> Este producto contiene una fuente de luz de la clase de eficiencia energética E  <b>(CZ)</b> Tento výrobek obsahuje světelný zdroj třídy energetické účinnosti E  <b>(PT)</b> Este produto contém uma fonte de luz da classe de eficiência energética E  <b>(GR)</b> Αυτό το προϊόν περιέχει μια φωτεινή πηγή ενεργειακής απόδοσης κλάσης E  <b>(SK)</b> Tento výrobok obsahuje zdroj svetla triedy energetickej efektivity E</p>	<p><b>QR</b></p> 	<p><b>EAN</b></p> <p>4251911726527</p>
---	--	--

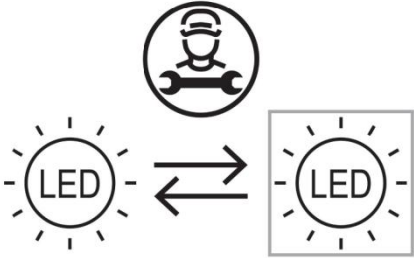
	<p><b>(DE)</b> Durch einen Fachmann austauschbare Lichtquelle (nur LED)  <b>(EN)</b> Replaceable (LED only) light source by a professional.  <b>(FR)</b> Source de lumière remplaçable (LED uniquement) par un professionnel.  <b>(NL)</b> Lichtbron (alleen led) te vervangen door een professional.  <b>(PL)</b> Wymienne (tylko LED) źródło światła wykonane przez profesjonalistę.  <b>(NO)</b> Utskiftbar (kun LED) lyskilde av en profesjonell.  <b>(DK)</b> Udskiftelig lyskilde (kun LED), udskiftes af en elektriker.  <b>(SE)</b> Ljuskälla (endast LED) utbytbar genom fackman.  <b>(FI)</b> Ammattilainen voi vaihtaa vaihdettavan (vain LED) valonlähteen.  <b>(IT)</b> Sorgente luminosa (solo LED) sostituibile da un professionista.  <b>(ES)</b> Fuente de luz (solo LED) sustituible por un profesional.  <b>(CZ)</b> Vyměnitelný (pouze LED) světelný zdroj odborníkem.  <b>(PT)</b> Luz LED (apenas LED) substituível por um profissional.  <b>(GR)</b> Η πηγή φωτός (μόνο LED) να αντικαθίσταται από επαγγελματία.  <b>(SK)</b> Zdroj svetla (iba LED) vymeniteľný prostredníctvom odborníka.</p>
--	--

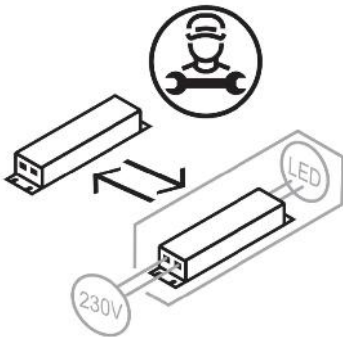
	<p><b>(DE)</b> Durch einen Fachmann austauschbares Betriebsgerät.  <b>(EN)</b> Replaceable control gear by a professional.  <b>(FR)</b> Contrôleur remplaçable par un professionnel.  <b>(NL)</b> Voorschakelapparatuur te vervangen door een professional.  <b>(PL)</b> Wymienny układ sterujący przez profesjonalistę.  <b>(NO)</b> Utskiftbar kontrollutstyr av en profesjonell.  <b>(DK)</b> Udskiftelig igangsætter, udskiftes af en elektriker.  <b>(SE)</b> Styrdon utbytbar genom fackman.  <b>(FI)</b> Ammattilainen voi vaihtaa vaihdettavat ohjauslaitteet.  <b>(IT)</b> Dispositivo di controllo sostituibile da un professionista.  <b>(ES)</b> Dispositivo de control sustituible por un profesional.  <b>(CZ)</b> Vyměnitelný předřadník odborníkem.  <b>(PT)</b> Dispositivo de controlo substituível por um profissional.  <b>(GR)</b> Ο εξοπλισμός ελέγχου να αντικαθίσταται από επαγγελματία.  <b>(SK)</b> Predradník vymeniteľný prostredníctvom odborníka.</p>
---	---