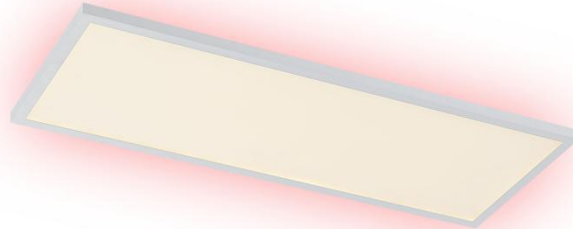

9624205

50W LED / 60W Total  
230V ~ 50Hz**(DE) Bestimmungsgemäße Verwendung****(GB) Intended use / (FR) Utilisation conforme / (NL) Beoogd gebruik / (PL) Stosowanie zgodnie z przeznaczeniem / (NO) Riktig bruk / (DK) Korrekt brug / (SE) Avsedd användning / (FI) Määräystenmukainen käyttö****(IT) Impiego appropriato / (ES) Uso prescrito / (CZ) Použití v souladu s určením / (PT) Utilização correta / (GR) Ενδεικτική χρήση**

<b>(DE)</b> Ortsfeste Verwendung als Deckenleuchte im Innenbereich	<b>(GB)</b> Provided for stationary indoor use on ceilings
<b>(FR)</b> Installation fixe en tant qu'plafonnier, à l'intérieur	<b>(NL)</b> Vast gebruik als plafondlamp binnenshuis
<b>(PL)</b> Do montażu stacjonarnego jako lampa sufitowa do wnętrz	<b>(NO)</b> Til stasjonært bruk som taklampe innendørs
<b>(DK)</b> Til stationær brug som loftlampe indendørs	<b>(SE)</b> Används som fast taklampe inomhus
<b>(FI)</b> Kiinteä käyttö sisätilojen kattovalaisimena	<b>(IT)</b> Impiego fisso come plafoniera in ambienti interni
<b>(ES)</b> Empleo fijo en tanto lámpara de techo en interiores	<b>(CZ)</b> Stacionární použití jako stropní svítidlo v interiéru
<b>(PT)</b> Aplicação fixa como luminária de teto em interiores	<b>(GR)</b> Σταθερή χρήση ως φωτιστικό οροφής σε εσωτερικό χώρο

**(DE) Verwendete Symbole****(GB) Safety Precautions / (FR) Symboles utilisés / (NL) Gebruikte symbolen / (PL) Stosowane symbole / (NO) Brukte symboler / (DK) Brugte symboler / (SE) Använda symboler / (FI) Käytetyt symbolit / (IT) Simboli usati / (ES) Símbolos empleados / (CZ) Použité symboly / (PT) Símbolos utilizados / (GR) Χρησιμοποιούμενα σύμβολα**IP 20 **(DE) Lieferumfang****(GB) Package contents / (FR) Contenu de la livraison / (NL) Bij de levering inbegrepen / (PL) Zakres dostawy / (NO) Leveringsomfang / (DK) Leveringsomfang / (SE) Leveransomfattning / (FI) Toimitussisältö / (IT) Fornitura / (ES) Volumen de suministro / (CZ) Rozsah dodávky / (PT) Material fornecido / (GR) Παραδοτέος εξοπλισμός**

<b>(DE)</b> 1 Deckenleuchte Montagematerial Montageanleitung	<b>(GB)</b> 1 Ceiling lamp Installation hardware Mounting instructions	<b>(FR)</b> 1 Plafonnier Matériel de montage Instructions de montage
<b>(NL)</b> 1 Plafondlamp Monteringsmateriale Montagehandleiding	<b>(PL)</b> 1 Lampa sufitowa Elementy montażowe Instrukcja montażu	<b>(NO)</b> 1 Taklampe Monteringsmateriale Brukerveiledning
<b>(DK)</b> 1 Loftlampe Monteringsmateriale Brugervejledning	<b>(SE)</b> 1 Taklampe Monteringsmaterial Monteringsanvisning	<b>(FI)</b> 1 Kattovalaisin Asennus materiaali Asennusohjeet
<b>(IT)</b> 1 Plafoniera Materiale di montaggio Istruzioni di montaggio	<b>(ES)</b> 1 Lámpara de techo Material de montaje Instrucciones de montaje	<b>(CZ)</b> 1 Stropní svítidlo Materiál pro montáž Návod k montáži
<b>(PT)</b> 1 Luminária de teto Material de montagem Instruções de montagem	<b>(GR)</b> 1 Φωτιστικό οροφής Υλικό συναρμολόγησης Οδηγίες συναρμολόγησης	

# ARCCHIO

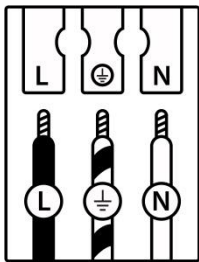
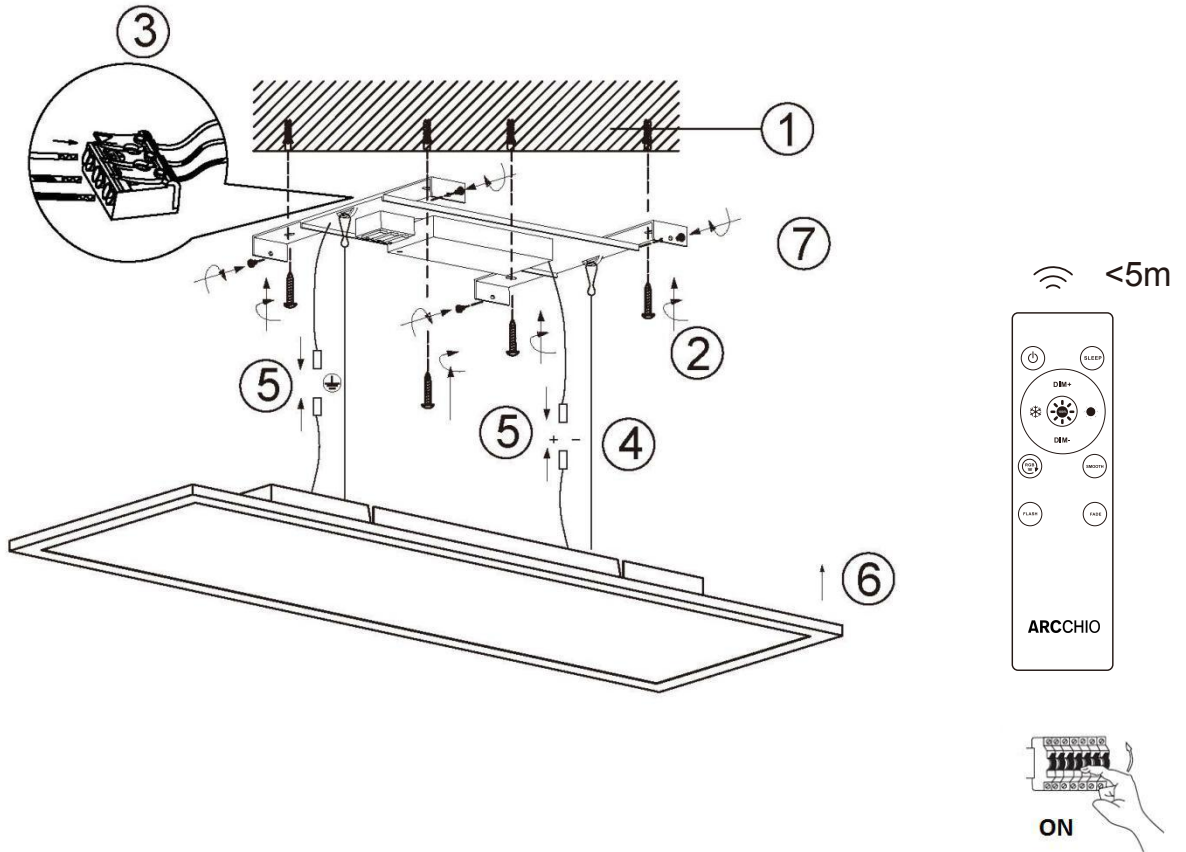
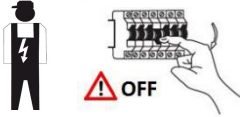









	(DE)	(GB)	(FR)	(NL)	(PL)	(NO)	(DK)
<b>L</b>	Stromführender Leiter	Live conductor	Conducteur	Spanningvoerende draad	Przewód prądowy	Strømførende leder	Strømførende leder
	Schutzleiter	Earth conductor	Conducteur de protection (terre)	Aardkabel	Przewód uziemiający	Jordledningen	Jordledningen
<b>N</b>	Neutralleiter	Neutral conductor	Conducteur neutre	Nulleider	Przewód zerowy	Nøytralleder	Neutralleider

	(SE)	(FI)	(IT)	(ES)	(CZ)	(PT)	(GR)
<b>L</b>	Strömförande ledare	Virtajohdin	Conduttore sotto tensione	Líneas conductoras de corriente	Vodič pod napětím	Condutor vivo	Ρευματοφόρος αγωγός
	Skyddsledare	Suojajohdin	Conduttore di terra	Conductor de protección	Ochranný vodič	Condutor de terra	Αγωγός γείωσης
<b>N</b>	Neutralledare	Nollajohdin	Conduttore neutro	Conductor neutro	Neutrální vodič	Condutor neutro	Ουδέτερος αγωγός

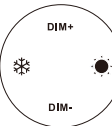
<p><b>(DE)</b> Die Lichtquelle dieser Leuchte ist nicht ersetzbar; wenn die Lichtquelle ihr Lebensdauerende erreicht hat, ist die gesamte Leuchte zu ersetzen.</p> <p><b>(FR)</b> La source lumineuse de cette lampe n'est pas remplaçable. Lorsque celle-ci ne fonctionnera plus, il faudra alors procéder à un échange complet du luminaire.</p> <p><b>(PL)</b> Źródło światła w tej lampie jest niewymienne, gdy osiągnie koniec żywotności, należy wymienić całą oprawę.</p> <p><b>(DK)</b> Lyskilden til denne lampe kan ikke udskiftes; når lyskilden har nået enden på sin levetid, vil hele lampen skulle udskiftes.</p> <p><b>(FI)</b> Tämän valaisimen valonlähde ei voi vaihtaa. Kun valonlähde on tullut elinkaarensa päähän, on koko valaisin vaihdettava.</p> <p><b>(ES)</b> La fuente de luz de esta lámpara no es reemplazable. Cuando la fuente de luz haya llegado al final de su vida útil, tiene que reemplazarse toda la lámpara.</p> <p><b>(PT)</b> A fonte de luz deste candeeiro não permite a substituição; quando a fonte de luz tiver atingido o fim de vida útil é necessário substituir o candeeiro completo.</p>	<p><b>(GB)</b> The light source of this luminaire is not replaceable; when the light source reaches its end of life, the whole luminaire shall be replaced.</p> <p><b>(NL)</b> De lichtbron van deze lamp is niet vervangbaar; wanneer de lichtbron het einde van zijn levensduur heeft bereikt, moet het complete armatuur vervangen worden.</p> <p><b>(NO)</b> Lyskilden i denne lampen er ikke mulig å bytte ut, når lyskildens livet tar slutt, må hele lampen skiftes ut.</p> <p><b>(SE)</b> Ljuskällan i denna lampa är inbyggd och är inte utbyttbar. När ljuskällan når sitt slutt, får man byta ut hela armaturen.</p> <p><b>(IT)</b> La sorgente luminosa di questa lampada non è sostituibile; quando la sorgente luminosa ha raggiunto la fine della sua vita utile, occorre sostituire l'intera lampada.</p> <p><b>(CZ)</b> Světelný zdroj nelze vyměnit, pokud světelný zdroj dosáhne konce své životnosti, je nutné vyměnit celé světlo.</p> <p><b>(GR)</b> Η πηγή φωτισμού αυτού του φωτιστικού δεν μπορεί να αντικατασταθεί. Όταν η πηγή φωτισμού φτάσει το τέλος της διάρκειας ζωής της, πρέπει να αντικαταστήσετε ολόκληρο το φωτιστικό.</p>
--	---

# Funktionsweise der Fernbedienung / operation with the remote control / Fonction de la télécommande

	(D)	(GB)	(F)
	EIN/ AUS	ON/ OFF	MARCHE/ ARRÊT
	100% Lumen mit Wechsel in den CCT-Modus	100% Lumen and transfer to CCT mode	100% lumens en mode CCT
	Beleuchtungsmodus (3000K-6000K) Dimmen (10%-100%)	Lighting mode (3000K-6000K) Dimmable (10%-100%)	Mode d'éclairage (3000K-6000K) Gradation(10% - 100%)
	Schlafmodus: Licht dimmt auf 10% & 3000K	Sleep Mode: switch on LED at 10% & 3000K	Mode veille : La lumière diminue à 10% et 3000K
	RGBW-Farbmodus	Switch on RGB & W mode	RVB & Blanc mode
	Smooth-Funktion: Alle Farben blinken gleichmäßig und abwechselnd	Smooth function: all colours will blink smoothly and alternately	Fonction Smooth : Toutes les couleurs clignent uniformément et alternativement
	Flash-Funktion: Alle Farben blinken abwechselnd	Flash function: all colours will blink alternately	Fonction Flash : Toutes les couleurs clignent alternativement
	Fade-Funktion: Alle Farben leuchten abwechselnd auf, wobei die Intensität zu- und abnimmt	Fade function: all colours will light up alternately and together will increasing and decreasing intensity	Fonction Fade : Toutes les couleurs s'allument en alternance, l'intensité augmentant et diminuant

 <5m

