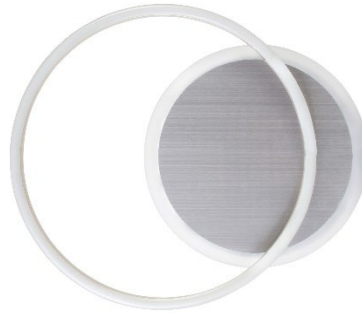

**9985094**
**2,9x 6W LED**

IEEE802.11b/g/n / 2,4GHz Wi-Fi

incl. 2,9x LED Board: L9002123

230V ~ 50Hz

**(DE) Bestimmungsgemäße Verwendung**
**(GB) Intended use / (FR) Utilisation conforme / (NL) Beoogd gebruik / (PL) Stosowanie zgodnie z przeznaczeniem / (NO) Riktig bruk / (DK) Korrekt brug / (SE) Avsedd användning / (FI) Määräystenmukainen käyttö**
**(IT) Impiego appropriato / (ES) Uso prescrito / (CZ) Použití v souladu s určením / (PT) Utilização correta / (GR) Ενδεδειγμένη χρήση**

<b>(DE)</b> Ortsfeste Verwendung als Deckenleuchte im Innenbereich	<b>(GB)</b> Provided for stationary indoor use on ceilings
<b>(FR)</b> Installation fixe en tant qu'plafonnier, à l'intérieur	<b>(NL)</b> Vast gebruik als plafondlamp binnenshuis
<b>(PL)</b> Do montażu stacjonarnego jako lampa sufitowa do wnętrz	<b>(NO)</b> Til stasjonært bruk som taklampe innendørs
<b>(DK)</b> Til stationær brug som loftlampe indendørs	<b>(SE)</b> Används som fast taklampan inomhus
<b>(FI)</b> Kiinteä käyttö sisätilojen kattovalaisimena	<b>(IT)</b> Impiego fisso come plafoniera in ambienti interni
<b>(ES)</b> Empleo fijo en tanto lámpara de techo en interiores	<b>(CZ)</b> Stacionární použití jako stropní svítidlo v interiéru
<b>(PT)</b> Aplicação fixa como luminária de teto em interiores	<b>(GR)</b> Σταθερή χρήση ως φωτιστικό οροφής σε εσωτερικό χώρο

**(DE) Verwendete Symbole**
**(GB) Safety Precautions / (FR) Symboles utilisés / (NL) Gebruikte symbolen / (PL) Stosowane symbole / (NO) Brukte symboler / (DK) Brugte symboler / (SE) Använda symboler / (FI) Käytetyt symbolit / (IT) Simboli usati / (ES) Símbolos empleados / (CZ) Použité symboly / (PT) Símbolos utilizados / (GR) Χρησιμοποιούμενα σύμβολα**

IP 20

**(DE) Lieferumfang**
**(GB) Package contents / (FR) Contenu de la livraison / (NL) Bij de levering inbegrepen / (PL) Zakres dostawy / (NO) Leveringsomfang / (DK) Leveringsomfang / (SE) Leveransomfattning / (FI) Toimitussisältö / (IT) Fornitura / (ES) Volumen de suministro / (CZ) Rozsah dodávky / (PT) Material fornecido / (GR) Παραδοτέος εξοπλισμός**

<b>(DE)</b> 1 Deckenleuchte Montagematerial Montageanleitung	<b>(GB)</b> 1 Ceiling lamp Installation hardware Mounting instructions	<b>(FR)</b> 1 Plafonnier Matériel de montage Instructions de montage
<b>(NL)</b> 1 Plafondlamp Monteringsmateriale Montagehandleiding	<b>(PL)</b> 1 Lampa sufitowa Elementy montażowe Instrukcja montażu	<b>(NO)</b> 1 Taklampe Monteringsmateriale Brukerveiledning
<b>(DK)</b> 1 Loftlampe Monteringsmateriale Brugervejledning	<b>(SE)</b> 1 Taklampan Monteringsmaterial Monteringsanvisning	<b>(FI)</b> 1 Kattovalaisin Asennusmateriaali Asennusohjeet
<b>(IT)</b> 1 Plafoniera Materiale di montaggio Istruzioni di montaggio	<b>(ES)</b> 1 Lámpara de techo Material de montaje Instrucciones de montaje	<b>(CZ)</b> 1 Stropní svítidlo Materiál pro montáž Návod k montáži
<b>(PT)</b> 1 Luminária de teto Material de montagem Instruções de montagem	<b>(GR)</b> 1 Φωτιστικό οροφής Υλικά συναρμολόγησης Οδηγίες συναρμολόγησης	

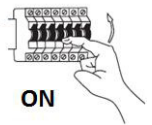
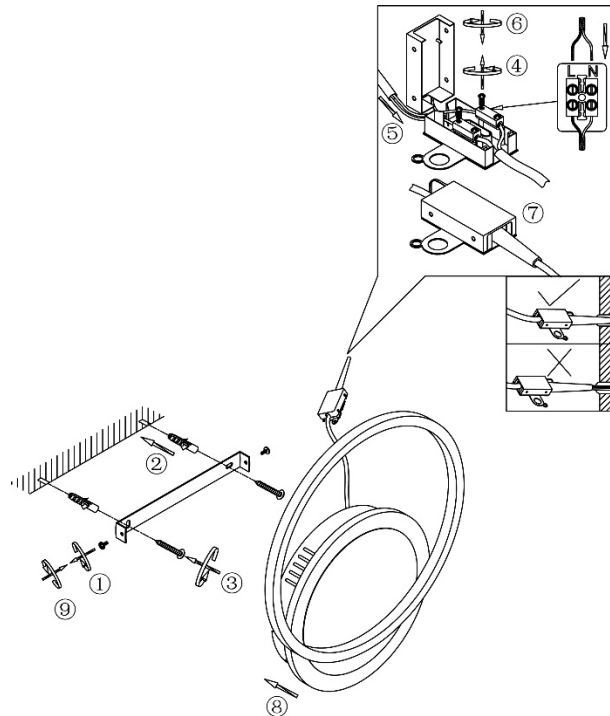
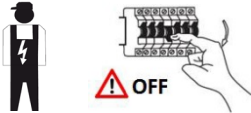

#### Steuerbar über Tuya Smart-App (WLAN mit Internetverbindung erforderlich)

1. Laden Sie die Tuya Smart-App aus dem App Store/ Play Store auf Ihr Smartphone.
2. Registrieren
3. Um bei der Leuchte den Tuya-Anlernmodus zu aktivieren, schalten Sie die Leuchte innerhalb von 3 Sekunden 3x über den Wandschalter ein und aus. Wenn das Licht 2x blinkt, war die Aktivierung erfolgreich.
4. Gehen Sie in der APP auf „Gerät hinzufügen“ (+), wählen Sie das entsprechende Gerät aus und folgen Sie den weiteren Anweisungen, um die Installation abzuschließen.

#### Controllable via Tuya Smart App (WiFi with internet connection required)

1. Download the Tuya Smart app for Android or iOS
2. Register
3. To activate the Tuya learning mode, switch the luminaire on and off 3x within 3 seconds via the wall switch. If the light flashes 2x, the activation was successful.
4. Choose "add device" (+) in the APP select the appropriate device and follow the further instructions to complete the installation.

#### Contrôlable via Tuya Smart App (WiFi avec connexion Internet requis)

1. Téléchargez l'application Tuya Smart pour Android ou iOS
2. S'inscrire
3. Pour activer le mode d'apprentissage Tuya, allumez et éteignez le luminaire 3 fois en 3 secondes via l'interrupteur mural. Si le luminaire clignote 2x, l'activation a réussi.
4. Choisissez "ajouter un dispositif" (+) dans l'APP, sélectionnez le dispositif approprié et suivez les instructions pour terminer l'installation.

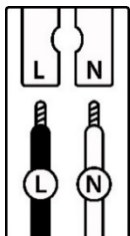

	(DE)	(GB)	(FR)	(NL)	(PL)	(NO)	(DK)
<b>L</b>	Stromführender Leiter	Live conductor	Conducteur	Spanningvoerende draad	Przewód prądowy	Strømførende leder	Strømførende leder
<b>N</b>	Neutralleiter	Neutral conductor	Conducteur neutre	Nulleider	Przewód zerowy	Nøytralleider	Neutralleider

	(SE)	(FI)	(IT)	(ES)	(CZ)	(PT)	(GR)
<b>L</b>	Strömförande ledare	Virtajohdin	Conduttore sotto tensione	Líneas conductoras de corriente	Vodič pod napětím	Condutor vivo	Ρευματοφόρος αγωγός
<b>N</b>	Neutralledare	Nollajohdin	Conduttore neutro	Conductor neutro	Neutrální vodič	Condutor neutro	Ουδέτερος αγωγός

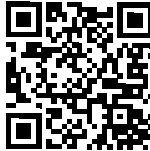
	QR	EAN
<p>(DE) Dieses Produkt enthält eine Lichtquelle der Energieeffizienzklasse F            (EN) This product contains a light source of energy efficiency class F            (FR) Ce produit comprend une source de lumière de classe d'efficacité énergétique F            (NL) Dit product bevat een lichtbron van energie-efficiëntieklasse F            (PL) Produkt ten zawiera źródło światła o klasie efektywności energetycznej F            (NO) Dette produktet inneholder en lyskilde i energieeffektivitetsklasse F            (DK) Dette produkt indeholder en lyskilde af energieeffektklasse F            (SE) Denna produkt innehåller en ljuskälla i energieffektivitetsklass F            (FI) Tämä tuote sisältää energiatehokkuusluokan F valonlähteen            (IT) Questo prodotto contiene una sorgente luminosa della classe di efficienza energetica F            (ES) Este producto contiene una fuente de luz de la clase de eficiencia energética F            (CZ) Tento výrobek obsahuje světelný zdroj třídy energetické účinnosti F            (PT) Este produto contém uma fonte de luz da classe de eficiência energética F            (GR) Αυτό το προϊόν περιέχει μια φωτεινή πηγή ενεργειακής απόδοσης κλάσης F            (SK) Tento výrobok obsahuje zdroj svetla triedy energetickej efektivity F</p>		<p>4251911740868</p>

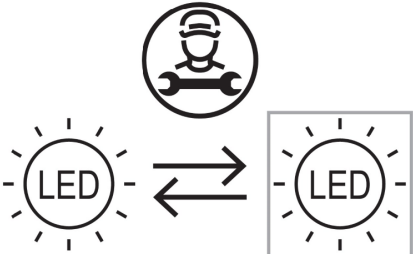
	<p>(DE) Durch einen Fachmann austauschbare Lichtquelle (nur LED)            (EN) Replaceable (LED only) light source by a professional.            (FR) Source de lumière remplaçable (LED uniquement) par un professionnel.            (NL) Lichtbron (alleen led) te vervangen door een professional.            (PL) Wymienne (tylko LED) źródło światła wykonane przez profesjonalistę.            (NO) Utskiftbar (kun LED) lyskilde av en profesjonell.            (DK) Udskiftelig lyskilde (kun LED), udskiftes af en elektriker.            (SE) Ljuskälla (endast LED) utbytbar genom fackman.            (FI) Ammattilainen voi vaihtaa vaihdettavan (vain LED) valonlähteen.            (IT) Sorgente luminosa (solo LED) sostituibile da un professionista.            (ES) Fuente de luz (solo LED) sustituible por un profesional.            (CZ) Vyměnitelný (pouze LED) světelný zdroj odborníkem.            (PT) Luz LED (apenas LED) substituível por um profissional.            (GR) Η πηγή φωτός (μόνο LED) να αντικαθίσταται από επαγγελματία.            (SK) Zdroj svetla (iba LED) vymeniteľný prostredníctvom odborníka.</p>
--	---

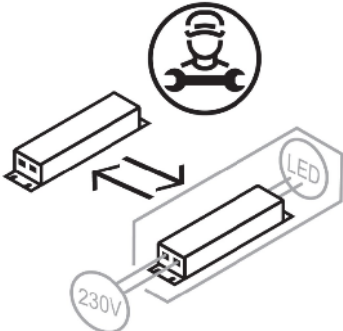
	<p>(DE) Durch einen Fachmann austauschbares Betriebsgerät.            (EN) Replaceable control gear by a professional.            (FR) Contrôleur remplaçable par un professionnel.            (NL) Voorschakelapparatuur te vervangen door een professional.            (PL) Wymienny układ sterujący przez profesjonalistę.            (NO) Utskiftbar kontrollutstyr av en profesjonell.            (DK) Udskiftelig igangsætter, udskiftes af en elektriker.            (SE) Styrdon utbytbar genom fackman.            (FI) Ammattilainen voi vaihtaa vaihdettavat ohjauslaitteet.            (IT) Dispositivo di controllo sostituibile da un professionista.            (ES) Dispositivo de control sustituible por un profesional.            (CZ) Vyměnitelný předřadník odborníkem.            (PT) Dispositivo de controlo substituível por um profissional.            (GR) Ο εξοπλισμός ελέγχου να αντικαθίσταται από επαγγελματία.            (SK) Predradník vymeniteľný prostredníctvom odborníka.</p>
---	--

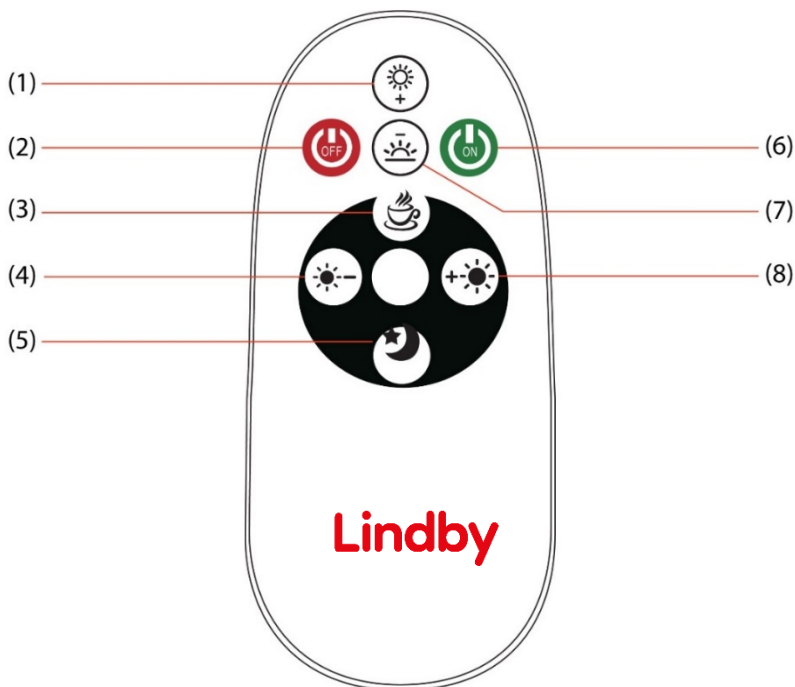

(1) Helligkeit +  
Kurzer Druck: 4-Stufen Dimmer  
Langer Druck: Stufenlos dimmen

(1) Dim up the brightness  
Short press: 4-step dimmable  
Long press: stepless dimmable

(1) Luminosité +  
Pression courte: gradateur à 4 niveaux  
Pression longue: gradation continue

(2) AUS/ OFF/ Arrêt

(3) 50% Helligkeit und Farbtemperatur  
(3) 50% brightness & color temperature  
(3) Luminosité et température de couleur de 50%

(4) Farbtemperatur -  
Kurzer Druck: 4 Stufen Farbtemperatur  
Langer Druck: stufenlos  
(4) Reduce color temperature  
Short press: 4-step color temperature  
Long press: stepless color temperature  
(4) Réduisez la température de couleur  
Pression courte: température de couleur en 4 étapes  
Pression longue: température de couleur en continu

(5) Nachlicht (10% Helligkeit)  
(5) Night light (10% brightness)  
(5) Veilleuse (luminosité 10%)

(6) AN/ ON/ MARCHE

(7) Helligkeit -  
Kurzer Druck: 4-Stufen Dimmer  
Langer Druck: Stufenlos dimmen

(7) Dim down the brightness  
Short press: 4-step dimmable  
Long press: stepless dimmable

(7) Luminosité -  
Pression courte: gradateur à 4 niveaux  
Pression longue: gradation continue

(8) Farbtemperatur +  
Kurzer Druck: 4 Stufen Farbtemperatur  
Langer Druck: stufenlos

(8) Increase color temperature  
Short press: 4-step color temperature  
Long press: stepless color temperature

(8) Augmentez la température de couleur  
Pression courte: température de couleur en 4 étapes  
Pression longue: température de couleur en continu

## Fernbedienung anlernen Programming the remote control Programmation de la télécommande

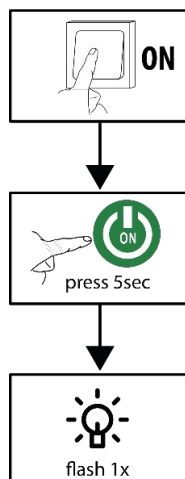

Schalten Sie die Leuchte über den Wandschalter ein.  
Halten Sie anschließend die grüne ON Taste ca. 5 Sekunden gedrückt.  
Wenn das Licht 1x flackert, war die Koppelung von Leuchte und Fernbedienung erfolgreich.

Turn on the light using the wall switch.  
Then press and hold the green ON button for approx. 5 seconds.  
If the light flashes once, the pairing of the light and the remote control was successful.

Allumez la lumière à l'aide de l'interrupteur mural.  
Appuyez ensuite sur le bouton vert ON pendant environ 5 secondes.  
Si la lumière clignote une fois, le couplage de la lumière et de la télécommande a réussi.