



DRAPER[®]

PETROL

CULTIVATOR/TILLER

04603



These instructions accompanying the product are the original instructions. This document is part of the product, keep it for the life of the product passing it on to any subsequent holder of the product. Read all these instructions before assembling, operating or maintaining this product.

This manual has been compiled by Draper Tools describing the purpose for which the product has been designed, and contains all the necessary information to ensure its correct and safe use. By following all the general safety instructions contained in this manual, it will ensure both product and operator safety, together with longer life of the product itself.

All photographs and drawings in this manual are supplied by Draper Tools to help illustrate the operation of the product.

Whilst every effort has been made to ensure the accuracy of information contained in this manual, the Draper Tools policy of continuous improvement determines the right to make modifications without prior warning.

1. TITLE PAGE

1.1 INTRODUCTION:

USER MANUAL FOR: Petrol Cultivator/Tiller

Stock No: 04603

Part No: CP145

1.2 REVISIONS:

Date first published October 2018.

As our user manuals are continually updated, users should make sure that they use the very latest version.

Downloads are available from: <http://drapertools.com/manuals>

Draper Tools Limited
Hursley Road
Chandler's Ford
Eastleigh
Hampshire
SO53 1YF
UK

Website: drapertools.com

Product Helpline: +44 (0) 23 8049 4344

General Fax: +44 (0) 23 8026 0784

1.3 UNDERSTANDING THIS MANUALS SAFETY CONTENT:

WARNING! – Information that draws attention to the risk of injury or death.

CAUTION! – Information that draws attention to the risk of damage to the product or surroundings.

1.4 COPYRIGHT © NOTICE:

Copyright © Draper Tools Limited.

Permission is granted to reproduce this publication for personal and educational use only. Commercial copying, redistribution, hiring or lending is prohibited.

No part of this publication may be stored in a retrieval system or transmitted in any other form or means without written permission from Draper Tools Limited.

In all cases this copyright notice must remain intact.

2. CONTENTS

2.1 CONTENTS

1. TITLE PAGE

1.1 INTRODUCTION.....	2
1.2 REVISION HISTORY	2
1.3 UNDERSTANDING THIS MANUAL	2
1.4 COPYRIGHT NOTICE	2

2. CONTENTS

2.1 CONTENTS.....	3
-------------------	---

3. WARRANTY

3.1 WARRANTY.....	4
-------------------	---

4. INTRODUCTION

4.1 SCOPE.....	5
4.2 SPECIFICATION	5
4.3 HANDLING AND STORAGE.....	5

5. HEALTH AND SAFETY INFORMATION

5.1 GENERAL SAFETY INSTRUCTIONS FOR POWER TOOL USE	6
5.2 SPECIFIC SAFETY INSTRUCTIONS FOR TILLER USE	7

6. TECHNICAL DESCRIPTION

6.1 IDENTIFICATION.....	10
-------------------------	----

7. UNPACKING AND CHECKING

7.1 PACKAGING	11
7.2 WHAT'S IN THE BOX	11

8. ASSEMBLY

8.1 ATTACHING THE HANDLE BAR	12
8.2 ATTACHING THE CABLE CLIPS.....	12
8.3 ATTACHING THE DRAG BAR	13
8.4 ATTACHING BLADES.....	13
8.5 ATACHING MUD GUARD	13

9. PREPARING THE TILLER

9.1 ENGINE OIL	14
9.2 AIR FILTER	14
9.3 FUEL	14
9.4 LIFT FRONT WHEEL	15
9.5 HANDLE BAR HEIGHT ADJUSTMENT.....	15
9.6 TILLING DEPTH ADJUSTMENT	15

10. BASIC TILLER OPERATION

10.1 STARTING THE ENGINE.....	16
10.2 FRONT WHEEL	17
10.3 CLUTCH OPERATION.....	17
10.4 STOPPING.....	17
10.5 TIPS ON USING YOUR TILLER	18

11. TROUBLESHOOTING

11.1 TROUBLESHOOTING	19
----------------------------	----

12. MAINTENANCE

12.1 MAINTENANCE	20
12.2 ADDING GEARBOX OIL	20
12.3 DRAINING GEARBOX OIL	20
12.4 AIR FILTER SERVICE	20
12.5 SPARK PLUG SERVICE	21
12.6 TRANSPORTING AND STORAGE	21

13. EXPLANATION OF SYMBOLS

13.1 EXPLANATION OF SYMBOLS	22
-----------------------------------	----

14. DISPOSAL

14.1 DISPOSAL	23
---------------------	----

DECLARATION OF CONFORMITY	ENCLOSED
---------------------------------	----------

3. WARRANTY

3.1 WARRANTY

Draper tools have been carefully tested and inspected before shipment and are guaranteed to be free from defective materials and workmanship.

Should the tool develop a fault, please return the complete tool to your nearest distributor or contact:

Draper Tools Limited, Chandler's Ford, Eastleigh, Hampshire, SO53 1YF. England.

Telephone Sales Desk: (023) 8049 4333 or:

Product Helpline (023) 8049 4344.

A proof of purchase must be provided.

If upon inspection it is found that the fault occurring is due to defective materials or workmanship, repairs will be carried out free of charge. This warranty period covering labour is 12 months from the date of purchase except where tools are hired out when the warranty period is 90 days from the date of purchase. The warranty is extended to 24 months from the date of purchase for parts only. This warranty does not apply to any consumable parts, any type of battery or normal wear and tear, nor does it cover any damage caused by misuse, careless or unsafe handling, alterations, accidents, or repairs attempted or made by any personnel other than the authorised Draper warranty repair agent.

Note: If the tool is found not to be within the terms of warranty, repairs and carriage charges will be quoted and made accordingly.

This warranty applies in lieu of any other warranty expressed or implied and variations of its terms are not authorised.

Your Draper warranty is not effective unless you can produce upon request a dated receipt or invoice to verify your proof of purchase within the warranty period.

Please note that this warranty is an additional benefit and does not affect your statutory rights.

Draper Tools Limited.

4. INTRODUCTION

4.1 SCOPE

This machine is designed to prepare the ground for flowers and vegetables. It has a four stroke petrol engine. Any other application is considered mis-use.

4.2 SPECIFICATION

Stock no.	04603
Part no.	CP145
Rated power	3.6kW
Fuel tank capacity	1.3L
Oil capacity.....	0.35L
Tilling width.....	360mm
Tilling depth	260mm
Vibration level:	
Left handlebar.....	11.06m/s ²
Right handlebar.....	7.72m/s ²
Sound pressure level	69.16dB(A)
Sound power level	93dB(A)
Weight	30kg

4.3 HANDLING AND STORAGE

Care must still be taken when handling and lifting. Dropping this machine will have an effect on the accuracy and may also result in personal injury. This machine is not a toy and must be respected. The environment will have a negative result on its operation if you are not careful. If the air is damp, components will rust. If the machine is unprotected from dust and debris; components will become clogged: And if not cleaned and maintained correctly or regularly the machine will not perform at its best.

5. HEALTH AND SAFETY INFORMATION

When using any type of power tool there are steps that should be taken to make sure that you, as the user, remain safe.

Common sense and a respect for the tool will help reduce the risk of injury.

5.1 GENERAL SAFETY INSTRUCTIONS FOR POWER TOOL USE

Warning!

- Read all safety warnings and all instructions. Failure to follow the warnings and instructions may result in electric shock, fire and/or serious injury.

Keep the work area tidy and clean. Attempting to clear clutter from around the machine during use will reduce your concentration. Mess on the floor creates a trip hazard. Any liquid spilled on the floor could result in you slipping.

Do not overload or misuse the tool. All tools are designed for a purpose and are limited to what they are capable of doing. Do not attempt to use a power tool (or adapt it in any way) for an application it is not designed for. Select a tool appropriate for the size of the job. Overloading a tool will result in tool failure and user injury. This covers the use of accessories.

Dress properly. Loose clothing, long hair and jewellery are all dangerous because they can become entangled in moving machinery. This can also result in parts of body being pulled into the machine. Clothing should be close fitted, with any long hair tied back and jewellery and neck ties removed. Footwear must be fully enclosed and have a non-slip sole.

Wear personal protective equipment (PPE). Dust, noise, vibration and swarf can all be dangerous if not suitably protected against. If the work involving the power tool creates dust or fumes wear a dust mask. Vibration to the hand, caused by operating some tools for longer periods must be protected against. Wear vibration reducing gloves and allow long breaks between uses. Protect against dust and swarf by wearing approved safety goggles or a face shield. These are some of the more common hazards and preventions, however, always find out what hazards are associated with the machine/work process and wear the most suitable protective equipment available.

Do not breathe contaminated air. If the work creates dust or fumes connect the machine (if possible) to an extraction system either locally or remotely. Working outdoors can also help if possible.

Move the machine as instructed. If the machine is hand held, do not carry it by the power supply cable. If the product is heavy, employ a second or third person to help move it safely or use a mechanical device. Always refer to the instructions for the correct method.

Do not overreach. Extending your body too far can result in a loss of balance and you falling. This could be from a height or onto a machine and will result in injury.

Maintain your tools correctly. A well maintained tool will do the job safely. Replace any damaged or missing parts immediately with original parts from the manufacturer. As applicable keep blades sharp, moving parts clean, oiled or greased, handles clean and emergency devices working.

Remove and check setting tools. Some machinery requires the use of additional tools or keys to set, load or adjust the power tool. Before starting the power tool always check to make certain they have been removed and are safely away from the machine.

Have this tool repaired by a qualified person. This tool is designed to conform to the relevant international and local standards and as such should be maintained and repaired by someone qualified, using only original parts supplied by the manufacturer. This will ensure the tool remains safe to use.

5. HEALTH AND SAFETY INFORMATION

5.2 SPECIFIC SAFETY INSTRUCTION FOR TILLER USE

Read the instructions carefully. Be familiar with the controls and the proper use of the equipment. Never allow children or people unfamiliar with these instructions to use the machine. Local regulations can restrict the age of the operator.

Never work while people, especially children, or pets are nearby. Keep in mind that the operator or user is responsible for accidents or hazards occurring to other people or their property.

While working always wear substantial footwear and long trousers. Do not operate the equipment when barefoot or wearing open sandals.

Thoroughly inspect the area where the equipment is to be used and remove all objects which can be thrown up by the machine.

Store fuel in containers specifically designed for this purpose.

Refuel outdoors only and do not smoke while refuelling.

Add fuel before starting the engine. Never remove the cap of the fuel tank or add petrol while the engine is running or when the engine is hot.

If petrol is spilled, do not attempt to start the engine but move the machine away from the area of spillage and avoid creating any source of ignition until petrol vapours have dissipated.

Replace all fuel tank and container caps securely.

Replace faulty silencers.

Before using, always visually inspect to see that the tools are not worn out or damaged. Replace worn out or damaged elements and bolts in set to preserve balance.

Do not operate the engine in a confined space where dangerous carbon monoxide fumes can collect.

Work only in daylight or in good artificial light.

Always be sure of your footing on slopes.

Walk, never run with the machine.

For wheeled rotary machines, work across the slopes, never up and down.

Use extreme caution when reversing or pulling the machine towards you.

Do not change the engine governor settings or over-speed the engine.

Start the engine carefully according to manufacturer instructions and with feet away from the tool.

Do not put your hands or feet near or under rotating parts.

Never pick up or carry a machine while the engine is running.

Stop the engine whenever you leave the machine, or before refuelling, when cleaning or while maintaining.

Reduce the throttle setting during engine shut down and, if the engine is provided with a shut-off valve, turn the fuel off at the conclusion of working.

Keep all nuts, bolts and screws tight to ensure the equipment is in safe working condition.

Never store the equipment with petrol in the tank inside a building where fumes can reach an open flame or spark.

Allow the engine to cool before storing in any enclosure.

To reduce the fire hazard, keep the engine, silencer, battery compartment and petrol storage area free of vegetative material and excessive grease.

Replace worn or damaged parts for safety.

If the fuel tank has to be drained, this shall be done outdoors.

5. HEALTH AND SAFETY INFORMATION

Keep the tiller in good operating condition. Operating a tiller in poor or questionable condition could result in serious injury.

Be sure all safety devices are in working order and warning labels are in place. These items are installed for your safety.

Be sure the safety covers (Fan cover, recoil starter cover) are in place.

Know how to stop the engine and tines quickly in case of emergency. Understand the use of all controls.

Keep a firm hold on the handlebars, they may tend to lift during clutch engagement.

Don't allow anyone without proper training to operate this tiller to avoid injury.

Be alert, operating this tiller when you are tired, ill or under the influence of alcohol or drugs may result in serious injury.

Keep all persons and pets away from the tilling area.

Be sure drag bar is in place and properly adjusted.

Keep children indoors and supervised at all times while outdoor power equipment is being used nearby, as young children move quickly and are attracted especially by the tiller and tilling activity.

Never assume children will remain where you last see them. Be alert and turn the tiller off if children enter the operation area.

Children should not be allowed to operate the tiller even under adult supervision.

Objects hit by the rotating tines can be thrown from the tiller with great force and may cause severe injury. Before tilling, clear the tilling area of sticks, large stones, wire, glass, etc.

Pieces thrown from worn or damaged tines can cause serious injury. Always inspect the tines before using the tiller.

WARNING: Petrol is extremely flammable and petrol vapour is explosive. Take extreme care when handling gasoline. Keep gasoline out of reach of children.

Refuel in a well ventilated area with the engine stopped.

Allow the engine to cool down before refuelling. Fuel vapour or spilled fuel may be ignited.

The engine and exhaust system become very hot during operation and remain hot for a while after stopping. Touching the hot engine components can cause burn injuries and can ignite some materials. Avoid touching a hot engine or exhaust system.

Allow the engine to cool down before performing maintenance or storing the tiller indoors.

WARNING: Exhaust contains poisonous carbon monoxide, a colourless and odourless gas. Breathing exhaust fumes can cause loss of consciousness, and even lead to death.

If you run the engine in an area that is confined or even partially enclosed, the air you breathe could contain a dangerous amount of exhaust gas. To keep exhaust gas from build-up, provide adequate ventilation.

When tilling on slopes, keep less than half tank of fuel to minimize fuel spillage.

Till across the slope (at equally spaced intervals) rather than up and down.

Be very careful when changing the direction of the tiller on a slope.

Do not use the tiller on a slope of more than 10%.

The maximum safe grade angle shown is for reference purpose only and should be determined

5. HEALTH AND SAFETY INFORMATION

according to the type of the tool before starting the engine, ensure that the tiller is not damaged and in good condition. For the safety of yourself and others, exercise extreme care when using the tiller up or down hills.

Adjust rotating depth according to the condition of the ground. Hoe hard ground in progressive stages.

Do not work on soggy ground; lumps of earth can be caught by the hoeing assembly and thrown out. If foreign bodies, e.g. stones, are encountered by the hoeing device, stop the machine, switch it off and check it for damage.

Do not work on any surfaces below which gas or power lines, or similar, are located.

Do not work close to trees otherwise the machine may cut through the roots.

6. TECHNICAL DESCRIPTION

6.1 IDENTIFICATION

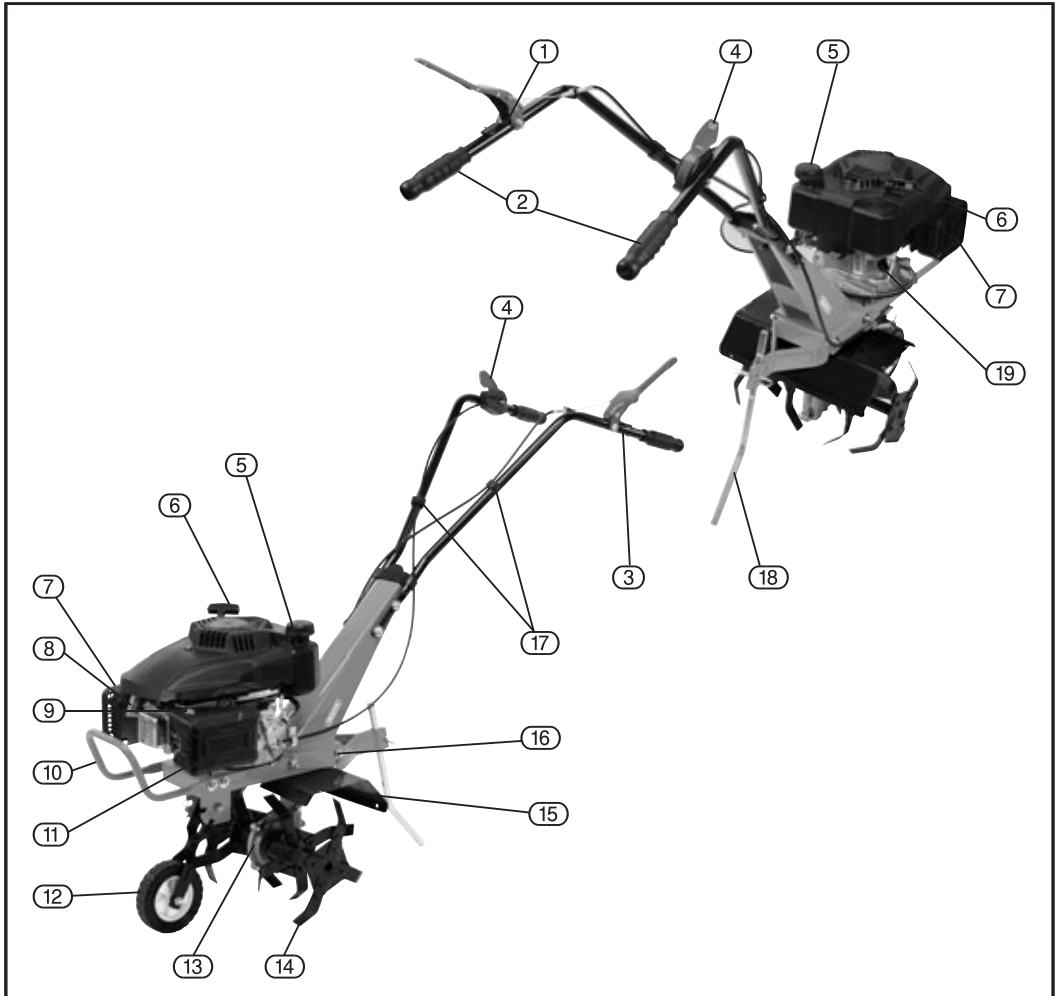

- | | | | |
|---|--------------------------|---|-------------------------------|
| ① | Emergency stop lever. | ⑪ | Air filter. |
| ② | Cushioned hand grips. | ⑫ | Front wheel. |
| ③ | Safety clutch lever. | ⑬ | Gear box. |
| ④ | Engine speed adjustment. | ⑭ | Blade assembly. |
| ⑤ | Fuel tank cap. | ⑮ | Mud fender. |
| ⑥ | Recoil starter. | ⑯ | Handle bar height adjustment. |
| ⑦ | Muffler. | ⑰ | Handle bars. |
| ⑧ | Spark plug. | ⑱ | Drag bar. |
| ⑨ | Primer bulb. | | |
| ⑩ | Front handle. | | |

7. UNPACKING AND CHECKING

7.1 PACKAGING

Carefully remove the product from the packaging and examine it for any sign of damage caused during shipping. Lay the contents out and check them. If any part is damaged or missing, do not attempt to use the tool and contact the Draper Helpline immediately (see back page for details). Retain the packaging material at least during the guarantee period: in case the machine needs to be returned for repair.

Warning! Some of the packaging materials used may be harmful to children, keep them out of reach from children.

Disposed of any packaging correctly and according to local regulations.

7.2 WHAT'S IN THE BOX?

As well as the main unit there are several parts not fitted or attached to it.

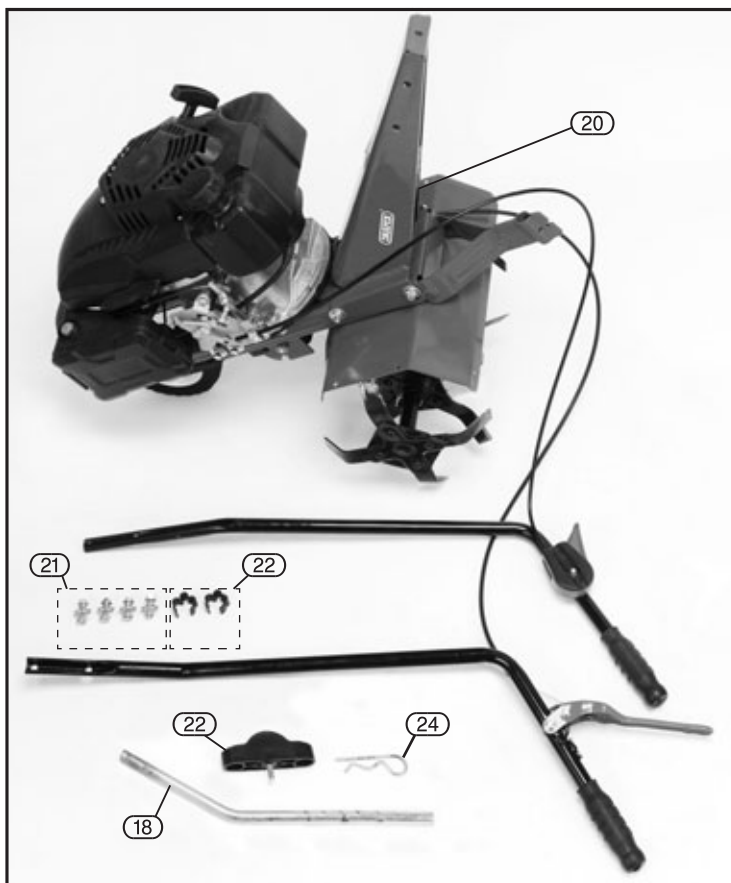

(20) Main assembly plus handles.

(21) Handle assembly bolts.

(22) Cable clips.

(23) Handle bar support.

(18) Drag bar.

(24) Drag bar connecting pin.

8. ASSEMBLY

8.1 ATTACHING THE HANDLE BAR - FIG. 1 - 3

1. Slide the Handle bracket (23) onto the ends of the handles. Attach the handle bars to the handle bar support with bolts only finger tight to the lower position as shown.
2. Swing the handles up, and slide the bracket (23) down onto the handle support. Insert bolt and tighten.
3. Insert the bolts through the upper holes. Tighten all bolts.

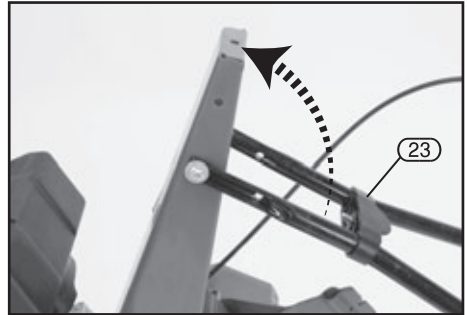

FIG.1

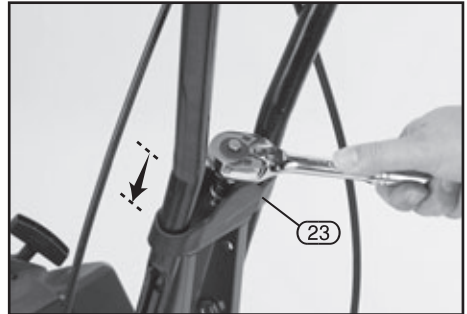

FIG.2



FIG.3

8.2 ATTACHING THE CABLE CLIPS- FIG. 4

1. Attach the cables onto the handles using the clips (22) provided.

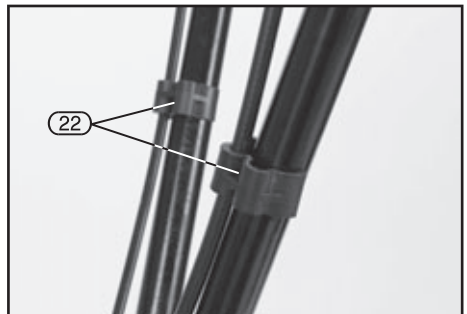

FIG.4

8. ASSEMBLY

8.3 ATTACHING THE DRAG BAR - FIG. 5

1. Attach the drag bar (18) to the drag bar holder, choose a suitable height and then lock the drag bar with the large R-type locking pin (24).

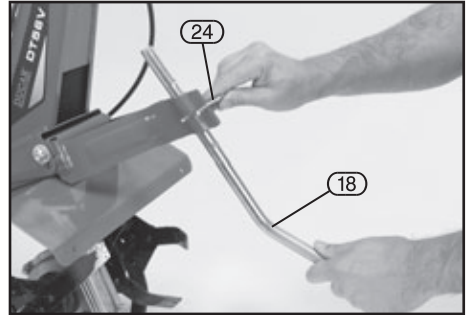

FIG.5

9. PREPARING THE TILLER

9.1 ENGINE OIL - FIG. 9

CAUTION: Running the engine with low oil level will cause serious engine damage.

1. Wipe the dipstick.
2. Put the dipstick into the oil filler neck, and screw it in.
3. If the level is low, fill the recommended oil to the middle of the dipstick.

SAE 10w-30 oil is recommended for general, all temperature use.

CAUTION: Using non-detergent oil or 2-stroke engine oil could shorten the engine's service life.

9.2 AIR FILTER - FIG. 10

Check air filter (25) for dirt or obstruction of elements.

9.3 FUEL - FIG. 11

Use automotive gasoline (Unleaded or low-leaded is preferred to minimize combustion chamber deposits.)

Never use an oil/gasoline mixture or dirty gasoline. Avoid dirt, dust or water from getting into the fuel tank.

CAUTION: Do not overfill the fuel tank (there should be no fuel in the filler neck).

WARNING: Gasoline is extremely flammable and is explosive under certain conditions.

Refuel in a well-ventilated area with the engine stopped. Do not smoke or allow flames or sparks in the area where the engine is refuelled or the gasoline is stored.

After refuelling make sure the tank cap is closed properly and securely.

Be careful not to spill fuel when refuelling. Spilled fuel or fuel vapour may be ignited. If any fuel is spilled, make sure the area is dry before starting the engine.

Avoid repeated or prolonged contact with skin or breathing of vapour.



FIG.9

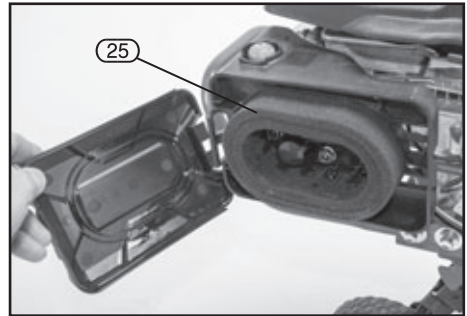

FIG.10



FIG.11

9. PREPARING THE TILLER

9.4 LIFT FRONT WHEEL - FIG. 12

Pull the front wheel bracket out of the location notch, swing the bracket down (The spring will pull the bracket back into the notch).

The tiller can stand with no other support.

With the wheel in the lower position the tiller can be wheeled into position, lift the handlebars up and ground the front wheel.

When the tiller is positioned ready to use, then the front wheel can be lifted into the raised position.

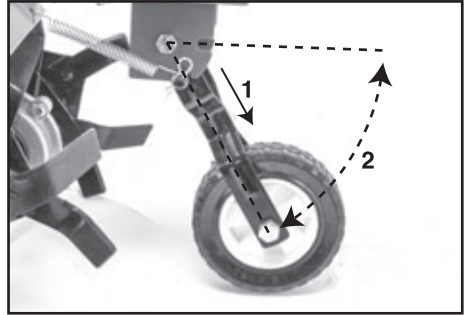

FIG.12

9.5 HANDLE BAR HEIGHT ADJUSTMENT - FIG. 13

CAUTION: Before adjusting the handle bar, place the tiller on firm level ground.

1. To adjust the tiller height, loosen the adjuster bolts (16) either side, select the appropriate height and tighten the bolt.

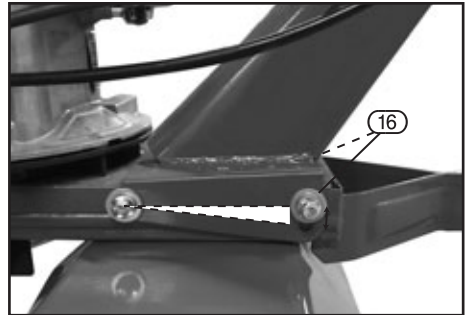

FIG.13

9.6 TILLING DEPTH ADJUSTMENT - FIG. 14

1. First attach the drag bar (18) into the drag bar holder, slide through to the required height and then lock the bar with R-type locking pin.

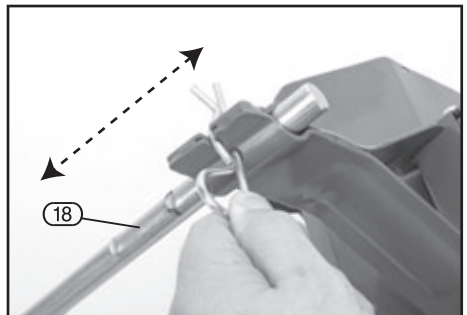

FIG.14

10. BASIC TILLER OPERATION

10.1 STARTING THE ENGINE - FIGS. 15 - 17

1. Pull the engine lever up slightly to "START RUN" (4).
2. Press the primer bulb (9) 3 times to prime the motor.
3. Pull the starter grip (6) lightly until resistance is felt then pull rapidly.

CAUTION: Do not allow the starter grip to snap back against the engine. Return it gently to prevent damage to the starter.

4. As the engine warms up, gradually lift the choke (4).

CAUTION: Be sure the clutch is disengaged to prevent sudden uncontrolled movement when the engine starts. The clutch is engaged by pulling in the clutch lever and disengaged by releasing the lever.



FIG.15

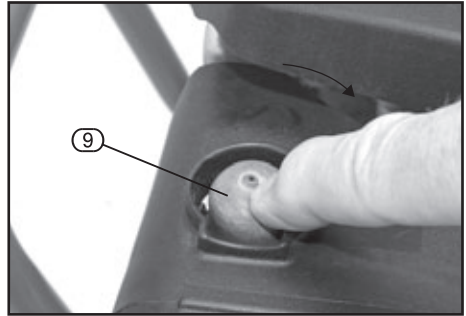

FIG.16

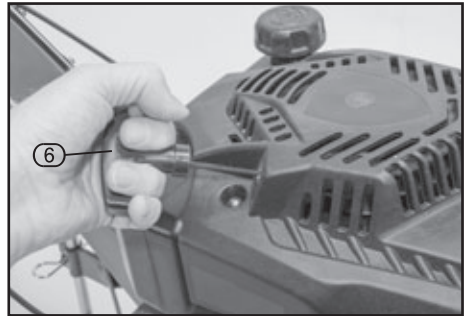

FIG.17

10. BASIC TILLER OPERATION

10.2 FRONT WHEEL - FIG. 18

When the tiller is in location ready to be used, lift the front wheel to the raised location.

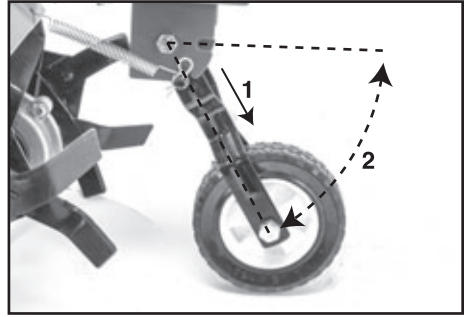

FIG.18

10.3 CLUTCH OPERATION - FIGS. 19 - 20

The clutch engages and disengages the power from the engine to the transmission.

The clutch lever (1) has a safety clip (1.1) which needs to be released before the clutch lever can be depressed.

Squeeze the clutch lever, and the rotating blades will rotate, release the clutch and they will stop.

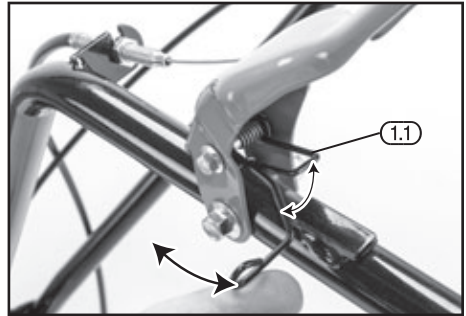

FIG.19

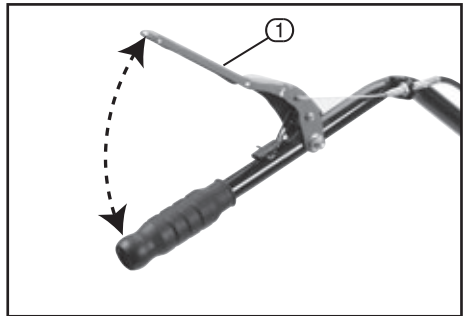

FIG.20

10.4 STOPPING - FIG. 21

In an emergency:

1. Push the engine switch/choke lever (5) to "STOP" position.

In normal use:

1. Disengage the clutch.
2. Push the engine switch/choke lever (5) to "STOP" position.



FIG.21

10. BASIC TILLER OPERATION

10.4 TIPS ON USING YOUR TILLER

Adjust the handlebar height to a comfortable position (usually waist height is recommended).

If the machine jerks forward while tilling, press down the handlebars; if the machine will not move forward, move the handlebars from side to side.

The proper method of negotiating a turn is to lower the handlebars to make the gravity of tiller backward centre toward the rear and then make the turn. This will permit a turn with relative ease.

CAUTION:

- Do not use the tiller with a rotor with diameter over 260mm.
- Operating the tiller on gradients could cause the tiller to tip over.
- Allowing any one to operate this tiller without proper instruction may result in injury.
- Wear sturdy, full coverage footwear. Operating this tiller on bare feet, or with open toe shoes or sandals increases your risk of injury.
- Do not use the tiller in the night.
- Be sure to transport the tiller from one place to another by two people, if a carrier is not available.
- When the rotor is clogged with mud, pebble etc, immediately stop the engine and clean the rotor in a safe place. Be sure to wear heavy gloves when cleaning the rotor.
- To prevent damage, check the tiller for any signs of damage or other faults each time when the tiller is used after it has been operated.



FIG.22

11. TROUBLESHOOTING

11.1 TROUBLESHOOTING

WARNING: For your own safety, turn the tiller off.

PROBLEM	POSSIBLE CAUSE	REQUIRED ACTION
<ul style="list-style-type: none">• Engine cannot be started.	<ul style="list-style-type: none">• Not enough fuel.• Fuel valve is OFF.• Engine switch is OFF.• Carburetor is blocked. • No spark from the spark plug.	<ul style="list-style-type: none">• Check fuel level in fuel tank.• Open the fuel valve.• Turn the engine switch ON.• Loosen the drain knob with the fuel valve ON. Fuel can flow out freely and then retighten drain knob.• Remove and clean the spark plug.
<ul style="list-style-type: none">• Clutch not working.	<ul style="list-style-type: none">• Engine speed is low.• Belt too long.• Spring failure.• Bearing inside gearbox failure.	<ul style="list-style-type: none">• Open throttle, increase engine speed.• Replace.• Replace.• Replace.
<ul style="list-style-type: none">• Sliding.	<ul style="list-style-type: none">• Spring/belt failure.	<ul style="list-style-type: none">• Replace.
<ul style="list-style-type: none">• Abnormal noise from gears.	<ul style="list-style-type: none">• Loose bearing.• Drive shaft deformed.• Gears wear out.	<ul style="list-style-type: none">• Replace.• Replace.• Replace.
<ul style="list-style-type: none">• Oil leakage.	<ul style="list-style-type: none">• O type sealing failure.• Loose bolts.	<ul style="list-style-type: none">• Replace.• Tighten.

If the engine still cannot be started, take the tiller to an authorized dealer.

12. MAINTENANCE

12.1 MAINTENANCE

WARNING: Turn off the engine before performing any maintenance. If the engine must be run, make sure the area has good-ventilation. The exhaust contains poisonous carbon monoxide gas.

CAUTION: Use only genuine parts or their equivalents. The use of replacement parts which are not of equivalent quality may damage the engine.

Drain the oil while the engine is still warm to assure rapid and complete drainage.

1. Remove the oil filler cap and drain the oil.
2. Refill with the recommended oil and check its level.

Wash your hands with soap and water after touching used oil.

NOTE: Please dispose used motor oil in a manner that is compatible with the environment. We suggest you put it in a sealed container to your local service for reclamation. Do not throw it to the trash can or pour it on the ground.

12.2 ADDING GEARBOX OIL - FIG. 22

- Removing rotating blades (see fitting rotating blades - 8.1).
- Unscrew the gearbox filling bolt (9.3) with a hexagon spanner, and remove it.
- Use gearbox oil SAE 85W-90.
- Carefully pour in gearbox oil (approx.200ml). Avoid spilling.
- Retighten the gearbox oil filling bolt.

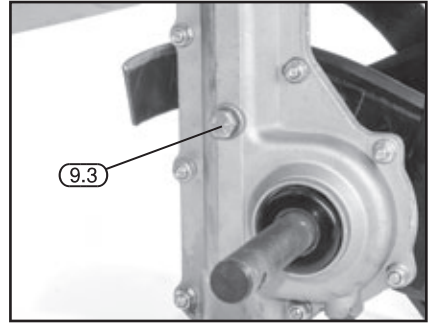

FIG.22

12.3 DRAINING GEARBOX OIL

- Hold a collection container beneath the gearbox oil filling bolt (9.3).
- Unscrew the gearbox oil filling bolt and remove.
- Allow the gearbox oil to run out completely.

12.4 AIR FILTER SERVICE

A dirty air cleaner will block air flow into the carburetor. To prevent carburetor malfunction, service the air cleaner regularly. Service more frequently when operating the engine in extremely dusty areas.

WARNING: Never use gasoline or low flash point solvents to clean the air cleaner element. This could result in a fire or explosion.

CAUTION: Never run the engine without air cleaner, or rapid engine wear will be the result.

1. Remove the wing nut and the air cleaner cover. Remove the elements and separate them. Carefully check elements for holes and tears, and replace it if damaged.
2. Foam element: clean in warm soapy water and allow to dry thoroughly or clean in high flash point solvent and allow to dry. Dip the element in clean engine oil and squeeze out all the excess. The engine will smoke during initial start up if too much oil is left in the foam.
3. Paper element: Tap the element lightly several times on a hard surface to remove excess dirt or blow compressed air through the filter from the inside out. Never try to brush the dirt off, for so doing will force dirt into the fibers.

12. MAINTENANCE

12.5 SPARK PLUG SERVICE - FIG. 23

Recommended spark plug: BPR5ES (NGK) / F7RTC (LG).

To ensure proper engine operation, the spark plug must be properly gapped and free of deposits.

1. Remove the spark plug cap (3.2).

WARNING: If the engine has been running the muffler will be very hot. Be careful not to touch the muffler.

2. Visually inspect the spark plug. Discard it if the insulator is cracked or chipped.
3. Measure the plug gap with a feeler gauge. The gap should be 0.7-0.8mm. Correct as necessary by bending the side electrode.
4. Attach the plug washer, thread the plug in by hand to prevent cross-threading.
5. When mounting a new spark plug, you should screw 1/2 more thread with the wrench after the washer is compressed. If you are mounting an old one, you should only screw 1/8-1/4 more thread.

CAUTION: The spark plug must be securely tightened. An improperly tightened plug can become very hot and possibly damage the engine. Never use a spark plug with an improper heat range.

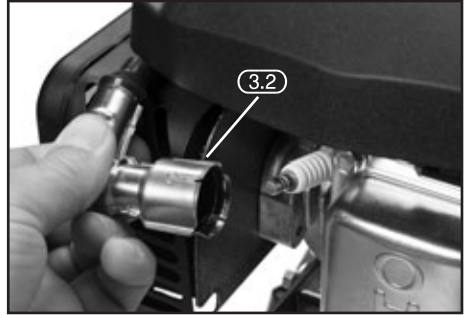

FIG.23

12.6 TRANSPORTING AND STORAGE - FIG. 24

WARNING: When transporting the tiller, turn the fuel valve OFF and keep the tiller level to prevent fuel spillage. Fuel vapor or spilled fuel may be easily ignited.

Before storing the unit for an extended period, follow below steps.

1. Be sure the storage area is free of excessive humidity and dust.
2. Drain the fuel.
 - With the fuel valve turned OFF, remove and empty the fuel strainer cup.
 - Remove tube clip (3.2) and drain the gasoline in the fuel tank into a suitable container.
 - Replace the fuel strainer cup and tighten securely.
 - Drain the carburetor by loosening the drain knob. Drain the gasoline into a suitable container.

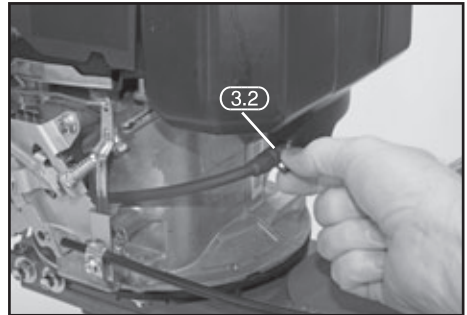

FIG.24

WARNING: Gasoline is highly flammable and explosive under certain conditions. Do not smoke or allow flames or sparks in the area.

3. Pull the starter grip until resistance is felt. Continue pulling until the notch on the starter puller aligns with the hole on the recoil starter. At this point, the intake and exhaust valves are closed and this will help to protect the engine from internal corrosion.
4. Change engine oil.
5. Cover tiller with plastic sheet.

Do not place the tiller with the handlebars on the ground. It will cause the oil entering the cylinder or fuel spillage.

13. EXPLANATION OF SYMBOLS

13.1 EXPLANATION OF SYMBOLS



Caution.



No open flame; Fire, open ignition source and smoking prohibited



Refer to instruction manual/booklet



Caution - Do not touch



Caution - hot surface!



Wear protective gloves



Warning!
Wear suitable eye/face protection.



Wear safety boots



Warning!
Wear ear defenders.



Keep bystanders away.



Single value noise marking.
(maximum declared
A-Weighted sound power level
in decibels).



WARNING:
Keep feet away from
sharp rotating blades

14. DISPOSAL

14.1 DISPOSAL

At the end of the machine's working life, or when it can no longer be repaired, ensure that it is disposed of according to national regulations.

Contact your local authority for details of collection schemes in your area.

In all circumstances:

- Do not dispose of power tools with domestic waste.
- Do not incinerate.
- Do not abandon in the environment.
- Do not dispose of WEEE* as unsorted municipal waste.

* Waste Electrical & Electronic Equipment.



CONTACTS

Draper Tools Limited, Hursley Road,
Chandler's Ford, Eastleigh, Hampshire. SO53 1YF. U.K.

Helpline: (023) 8049 4344

Sales Desk: (023) 8049 4333

Internet: drapertools.com

E-mail: sales@drapertools.com

General Enquiries: (023) 8026 6355

Service/Warranty Repair Agent:

For aftersales servicing or warranty repairs, please contact the
Draper Tools Helpline for details of an agent in your local area.

YOUR DRAPER STOCKIST

KCMC1018

©Published by Draper Tools Limited.

No part of this publication may be reproduced, stored in a retrieval system or transmitted in any form or by any means, electronic, mechanical photocopying, recording or otherwise without prior permission in writing from Draper Tools Ltd.