

DRAPER®

INSTRUCTIONS FOR **Bench Mounted Spindle Moulder**

Stock No.09536

Part No.BMSM

IMPORTANT: PLEASE READ THESE INSTRUCTIONS CAREFULLY TO ENSURE THE SAFE AND EFFECTIVE USE OF THIS PRODUCT.



CE

DRAPER®

GENERAL INFORMATION

This manual has been compiled by Draper Tools and is an integrated part of the product with which it is enclosed and should be kept with it for future references.

This manual describes the purpose for which the product has been designed and contains all the necessary information to ensure its correct and safe use. We recommend that this manual is read before any operation or, before performing any kind of adjustment to the product and prior to any maintenance tasks. By following all the general safety instructions contained in this manual, it will ensure both product and operator safety, together with longer life of the product itself.

All photographs and drawings in this manual are supplied by Draper Tools to help illustrate the operation of the product.

Whilst every effort has been made to ensure accuracy of information contained in this manual, the Draper Tools policy of continuous improvement determines the right to make modifications without prior warning.



CONTENTS

Contents/Guarantee 1

Specification..... 2

Power supply..... 3

General safety instructions 4

Additional safety instructions 5

Getting to know your spindle moulder..... 6

Assembly 7-12

Operation and use..... 13-14

Disposal of power tools..... 15

Declaration enclosed



GUARANTEE

Draper tools have been carefully tested and inspected before shipment and are guaranteed to be free from defective materials and workmanship.

Should the tool develop a fault, please return the complete tool to your nearest distributor or contact Draper Tools Limited, Chandler’s Ford, Eastleigh, Hampshire, SO53 1YF England.

Telephone Sales Desk: (023) 8049 4333 or Product Helpline (023) 8049 4344.

A proof of purchase must be provided with the tool.

If upon inspection it is found that the fault occurring is due to defective materials or workmanship, repairs will be carried out free of charge. This guarantee period covering parts/labour is 12 months from the date of purchase except where tools are hired out when the guarantee period is ninety days from the date of purchase. The guarantee is extended to 24 months for parts only. This guarantee does not apply to normal wear and tear, nor does it cover any damage caused by misuse, careless or unsafe handling, alterations, accidents, or repairs attempted or made by any personnel other than the authorised Draper warranty repair agent.

Note: If the tool is found not to be within the terms of warranty, repairs and carriage charges will be quoted and made accordingly.

This guarantee applies in lieu of any other guarantee expressed or implied and variations of its terms are not authorised.

Your Draper guarantee is not effective unless you can produce upon request a dated receipt or invoice to verify your proof of purchase within the guarantee period.

Please note that this guarantee is an additional benefit and does not affect your statutory rights.

Draper Tools Limited.



SPECIFICATION

The Draper Tools policy of continuous improvement determines the right to change specification without notice.

Stock no.	09536
Part no.....	BMSM
Rated voltage.....	230V~50Hz
Rated input.....	1500W
Spindle speed	11,500 - 24,000rpm
Spindle travel	0-40mm
Table size	610 x 360mm
Table size with extension wings.....	1030 x 360mm
Dimensions	1030 x 360 x 311mm
Sound pressure level	105.5dB(A)
Sound power level.....	92.5dB(A)
Weight (Machine only)	30.0kg (Nett)

Always wear an approved dust mask, safety goggles and ear protection.

Due to the weight of this item, seek assistance and do not under any circumstances lift this machine by the table extension wings.

CAUTION: Risk of electric shock. Do not open.

This appliance is supplied with a moulded 3 pin mains plug for your safety. The value of the fuse fitted is marked on the pin face of the plug. Should the fuse need replacing, ensure the substitute is of the correct rating, approved to BS1362 and ASTA or BS Kite marked.



The fuse cover is removable with a small plain slot screwdriver. Ensure the fuse cover is replaced before attempting to connect the plug to an electrical outlet. If the cover is missing, a replacement must be obtained or the plug replaced with a suitable type.

If a replacement plug is to be fitted this must be carried out by a qualified electrician.

The damaged or incomplete plug, when cut from the cable shall be disabled to prevent connection to a live electrical outlet.

This appliance is Class II[†] and is designed for connection to a power supply matching that detailed on the rating label and compatible with the plug fitted.

If an extension lead is required, use an approved and compatible lead rated for this appliance. Follow all the instruction supplied with the extension lead.

[†]Double insulated : This product requires no earth connection as supplementary insulation is applied to the basic insulation to protect against electric shock in the event of failure of the basic insulation.

IMPORTANT:

On products exceeding 2000W it is recommended that the power cable and/or extension cable are fully unwound before a connection is made to the power supply. However, ensure the residual cable does not pose a trip hazard

GENERAL SAFETY INSTRUCTIONS

WARNING: When using electric tools basic safety precautions should always be followed to reduce the risk of fire, electric shock and personal injury including the following.

Read all these instructions before attempting to operate this product and save these instructions.

SAFE OPERATION

1. KEEP WORK AREA CLEAR

- Cluttered areas and benches invites injuries.

2. CONSIDER WORK AREA ENVIRONMENT

- Do not expose tools to rain.
- Do not use tools in damp or wet locations.
- Keep work area well lit.
- Do not use tools in the presence of flammable liquids or gases.

3. GUARD AGAINST ELECTRIC SHOCK

- Avoid body contact with earthed or grounded surfaces (e.g. pipes, radiators, ranges, refrigerators).

4. KEEP OTHER PERSONS AWAY

- Do not let persons, especially children, not involved in the work touch the tool or the extension cord and keep them away from the work area.

5. STORE IDLE TOOLS

- When not in use, tool should be stored in a dry locked-up place, out of reach of children.

6. DO NOT FORCE THE TOOL

- It will do the job better and safer at the rate for which it was intended.

7. USE THE RIGHT TOOL

- Do not force tools to do the job of a heavy duty tool.
- Do not use tools for purposes not intended; for example do not use circular saws to cut tree limbs or logs.

8. DRESS PROPERLY

- Do not wear loose clothing or jewellery, they can be caught in moving parts.
- Non-skid footwear is recommended when working outdoors.
- Wear protective hair covering to contain long hair.

9. USE PROTECTIVE EQUIPMENT

- Use safety glasses.
- Use face or dust mask if working operations create dust.

10. CONNECT DUST EXTRACTION EQUIPMENT

- If the tool is provided for the connection of dust extraction and collecting equipment, ensure these are connected and properly used.

11. DO NOT ABUSE THE CORD

- Never yank the cord to disconnect it from the socket. Keep the cord away from heat, oil and sharp edges.

12. SECURE WORK

- Where possible use clamps or a vice to hold the work. It is safer than using your hand.

13. DO NOT OVERREACH

- Keep proper footing and balance at all times.

14. MAINTAIN TOOLS WITH CARE

- Keep cutting tools sharp and clean for better and safer performance.
- Follow instruction for lubricating and changing accessories.
- Inspect tool cords periodically and if damaged have them repaired by an authorized service facility.
- Inspect extension cords periodically and replace if damaged.
- Keep handles dry, clean and free from oil and grease.

15. DISCONNECT TOOLS

- When not in use, before servicing and when changing accessories such as blades, bits and cutters, disconnect tools from the power supply.

16. REMOVE ADJUSTING KEYS AND WRENCHES

- Form the habit of checking to see that keys and adjusting wrenches are removed from the tool before turning it on.

17. AVOID UNINTENTIONAL STARTING

- Ensure switch is in "off" position when plugging in.

18. USE OUTDOOR EXTENSION LEADS

- When the tool is used outdoors, use only extension cords intended for outdoor use and so marked.

19. STAY ALERT

- Watch what you are doing, use common sense and do not operate the tool when you are tired.

20. CHECK DAMAGED PARTS

- Before further use of tool, it should be carefully checked to determine that it will operate properly and perform its intended function.
- Check for alignment of moving parts, binding of moving parts, breakage of parts, mounting and any other conditions that may affect its operation.
- A guard or other part that is damaged should be properly repaired or replaced by an authorized service centre unless otherwise indicated in this instruction manual.
- Have defective switches replaced by an authorized service centre.
- Do not use the tool if the switch does not turn it on and off.

21. WARNING

- The use of any accessory or attachment other than one recommended in this instruction manual may present a risk of personal injury.

22. HAVE YOUR TOOL REPAIRED BY A QUALIFIED PERSON

- This electric tool complies with the relevant safety rules. Repairs should only be carried out by qualified persons using original spare parts, otherwise this may result in considerable danger to the user.

WARNING

For your own safety, do not operate your spindle moulder until it is completely assembled and installed according to the instructions....and until you have read and understood the safety rules, assembly procedures, adjustment procedures and maintenance etc.

1. STABILITY.

There may be a tendency for the spindle moulder to tip over or move during certain cutting operations, such as, working with extremely large heavy panels or long heavy boards.

2. MINIMISE POTENTIAL ACCIDENTS.

Most accidents are caused by FAILURE TO FOLLOW SET UP AND OPERATION INSTRUCTIONS.

Avoid awkward hand positions, where a sudden slip could cause a hand to move into the cutting tool. Never reach behind, or around, the cutting tool with either hand to hold down the workpiece, or for any other reason. DO NOT PLACE FINGERS OR HANDS IN THE PATH OF THE CUTTING TOOL.

3. Never reach under or over your machine when operating or make any adjustments when it is running.
4. Turn the spindle moulder 'OFF' and disconnect the power supply when changing the cutting tool, or making any adjustments.
5. Always maintain control of the workpiece. DO NOT 'LET GO' of the workpiece until the machine has stopped.
6. When removing short workpieces, or cleaning up around the table, be sure the router is switched 'OFF'.
7. Never turn the spindle moulder 'ON' before clearing the table of all tools, wood scraps, etc., except the workpiece and related feed or support devices for the operation.
8. When moving the spindle moulder, disconnect power supply.
WARNING: Do not allow familiarity (gained from frequent use of your spindle moulder) to become commonplace. Always remember that a careless fraction of a second is sufficient to inflict severe injury.
9. MAKE SURE YOUR FINGERS DO NOT CONTACT THE TERMINALS OF THE POWER PLUG when installing or removing from the mains power supply.
10. Do not attempt to remove excess material in one pass.
11. Always feed against the cutter's direction of rotation.
12. Read and understand the instructions supplied with the machine before attempting to use this spindle moulder.
13. AVOID KICKBACK. Never stand directly behind the workpiece. Under no circumstances use the mitre guide with the fence, as a dangerous kickback may result.

14. IF YOUR SPINDLE MOULDER MAKES AN UNFAMILIAR NOISE OR IF IT VIBRATES EXCESSIVELY, CEASE OPERATING IMMEDIATELY UNTIL THE SOURCE HAS BEEN LOCATED AND THE PROBLEM CORRECTED. sawing wood.

- Do not use High speed steel (HSS) blades;
- The push-stick or push block should always be stored with the machine when not in use.

SAFE OPERATION

- Use push-sticks or push blocks to feed the workpiece past the cutter;
- Use and ensure correct adjustment of the guard is observed.
- Use only cutters for which the maximum possible speed is not less than the maximum spindle speed of the tool and is suitable for the material to be cut.
- When transporting the machine use only transportation devices and never use guards for handling or transportation.

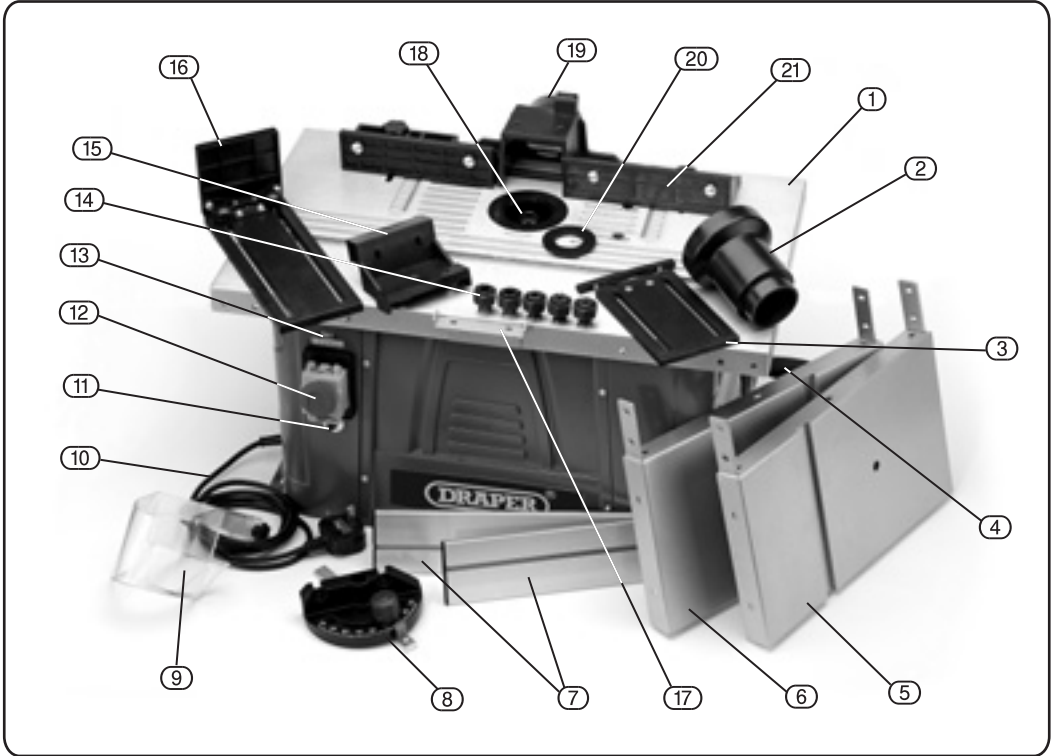

- ① Work table.
- ② Dust extraction adaptor.
- ③ Upper workpiece guide.
- ④ Height adjustment handle.
- ⑤ Right extension table.
- ⑥ Left extension table.
- ⑦ Guide fence.
- ⑧ Mitre guide.
- ⑨ Router bit guard.
- ⑩ Power cord.
- ⑪ Automatic stop reset switch.
- ⑫ On/off switch (emergency stop switch located on the switch cover).
- ⑬ Variable speed switch.
- ⑭ Reducing bushes.
- ⑮ Upper guide bracket.
- ⑯ Lower workpiece guide.
- ⑰ Lower guide bracket.
- ⑱ Router bit chuck.
- ⑲ Dust extraction.
- ⑳ Insert plate.
- ㉑ Rear moulded fence.

- **UNPACKING:** After removing the packing material, make sure the product is in perfect condition and that there are no visible damaged parts. If in doubt, do not use the spindle moulder and contact the dealer from whom it was purchased.

The packaging materials (plastic bags, polystyrene, etc.), must be disposed of in an appropriate refuse collection container. These materials must not be left within the reach of children as they are potential sources of danger.

- **ASSEMBLY OF REAR MOULDED FENCE (Figs.1 - 3):**
- Slide the moveable back plate (A) into grooves (B) found on the rear moulded fence (C). Fig.1.

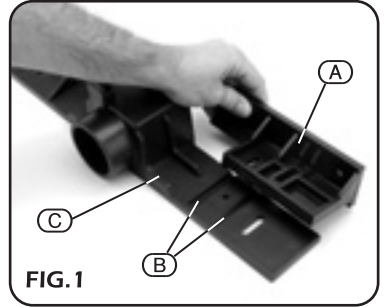

- Attach the moveable back plate to the rear moulded fence using bolt (D). Fig.2.

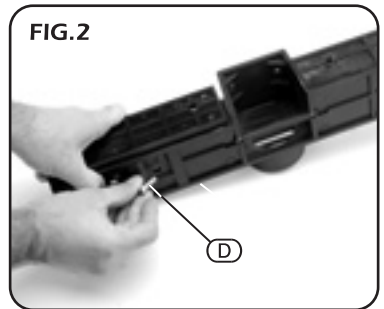

- Secure the back plate in place using the plastic nut (E). Fig.3.

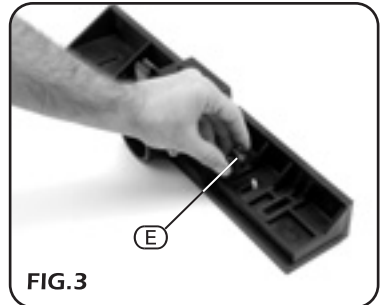

- **FITTING THE LEFT & RIGHT REAR FENCE PLATES TO THE REAR MOULDED FENCE (Figs.4 - 6):**
- Slide x2 securing bolts (F) into both left and right rear fence plates (G). Fig 4.

FIG.4

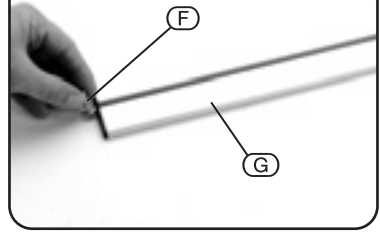

- Locate the securing bolts (F) into the corresponding holes (H) found on the rear moulded fence. Fig.5.

FIG.5

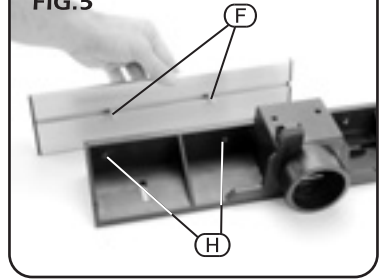

- Secure the rear fence plates to the moulded fence using plastic nuts (I). Fig.6.

FIG.6

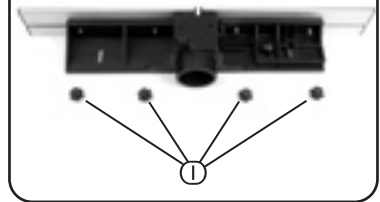

- **DUST EXTRACTION (Fig.7):**
- Once the rear moulded fence has been assembled, attach the dust extraction adaptor (J) if needed.

FIG.7

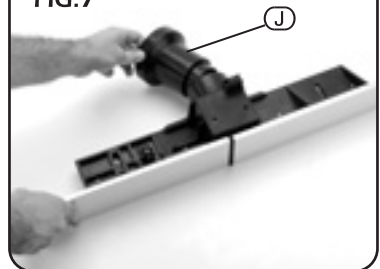

- FITTING THE ROUTER BIT GUARD (Figs.8 & 9):

- The router bit guard (K) must be used when the upper and lower blade guides are not in use. Plastic securing nut (L) and bolt (M) are required to attach the guard to the rear moulded fence. Fig.8.

FIG.8

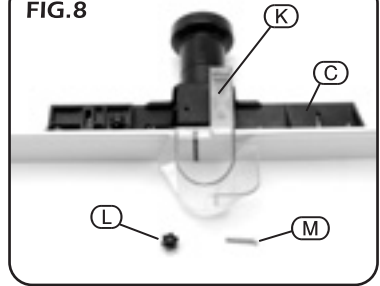

- The router bit guard is attached to the rear moulded fence by feeding the bolt (M) through the guard and moulded fence locating holes and securing with plastic nut (L). Fig.9.

FIG.9

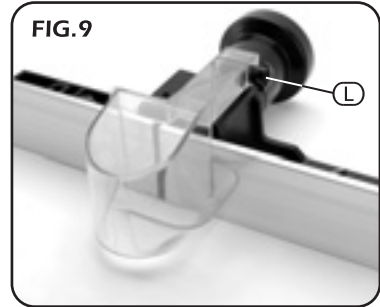

- FIXING THE REAR FENCE TO THE WORK TABLE (Figs.10 - 14):

- Place the fully assembled rear moulded fence onto the work table. Fig.10.

FIG.10



- Remove the front panel (N) by removing the x4 cross slot screws (O) using a cross slotted screwdriver (not supplied). Fig.11.

Note: Ensure spindle moulder is unplugged from the mains power supply.

FIG.11

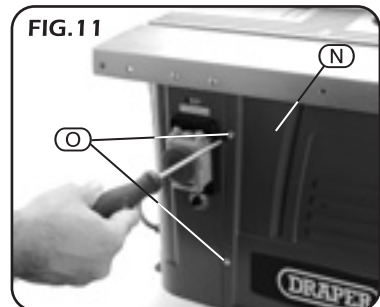

- Once the front panel has been removed, insert bolts (P) into the rear moulded fence locating holes. The locating holes can be found at the rear of the spindle moulder on the underside of the table top either side of the motor. Fig.12.

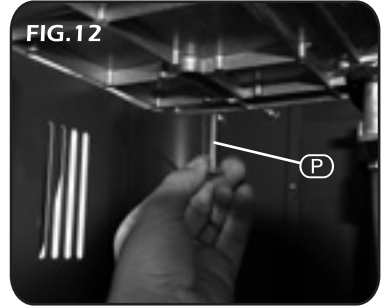

- Each fixing bolt (P) will pass through both the work table and the rear moulded guide fence. Fig.13.

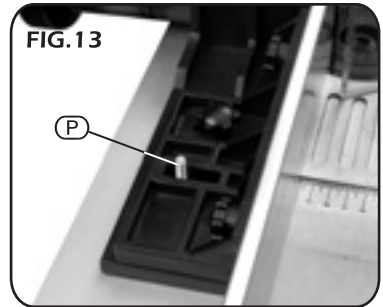

- Fix the rear moulded guide fence to the work table using plastic nut (Q). Fig.14.

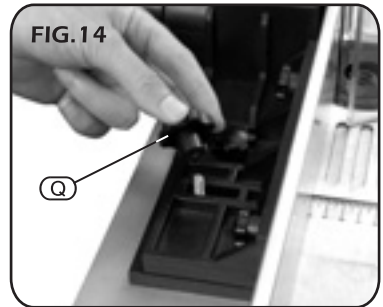

- **ATTACHING THE SIDE EXTENSION WINGS (Figs.15 - 17):**
- To attach the left and right extension wings (R) slide guides (S) in the corresponding grooves (T). Fig.15.

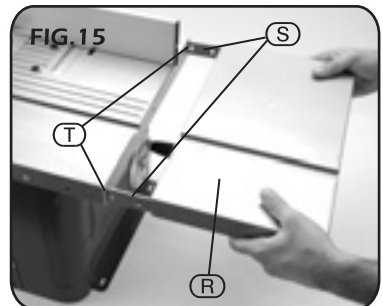

- Holding the extension wings in place using one hand, insert x4 hex bolts (U) through fixing holes (V). Fig.16.
- When fixing the extension wings ensure the use of the correct washers and fixing rings.

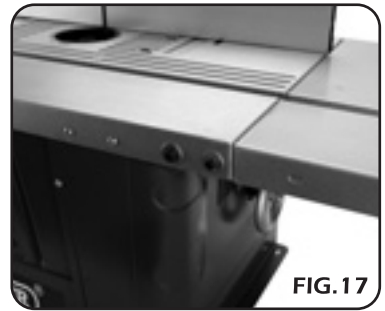
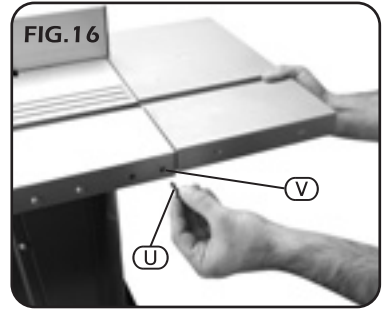

- ASSEMBLY OF THE LOWER PUSH GUIDE (Figs.18 & 19):

- Fix the lower push guide bracket (W) to the table top using x2 cross slot screws (X). Fig.18.

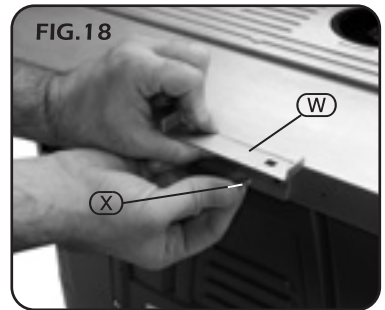

- Attach the lower push guide to the bracket (W) using x2 bolts and plastic nuts (Y). Fig.19.

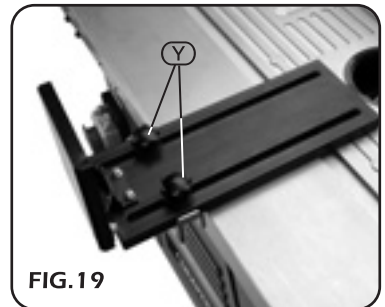

- **ATTACHING THE MITRE GUIDE (Fig.20):**

- The mitre guide (Z) is used when the operator wishes to perform angled cuts. The mitre guide simply slides into work table groove (AA). Fig.20.

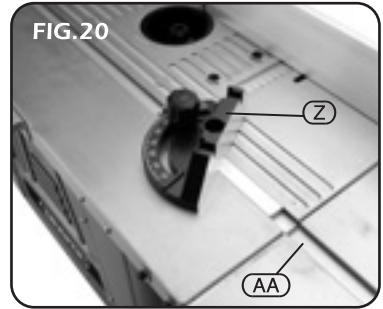

- **INSERT PLATES (Fig.21):**

- The spindle moulder is supplied with a selection of insert plates (AB). The insert plates are 3 different sizes - one plate is to be used dependant on the router bit size. Fig.21.

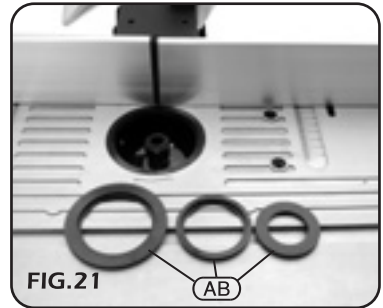

- **ROUTER BIT REDUCING BUSHES (Figs.22 & 23):**

- Select the desired reducing bush (AC) and then push and screw down onto threaded spindle (AD). Fig.22.

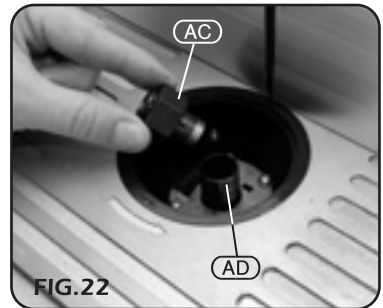

- Ensure the reducing bush (AC) is fully tightened by using the spanner (AE) supplied. Fig.23.

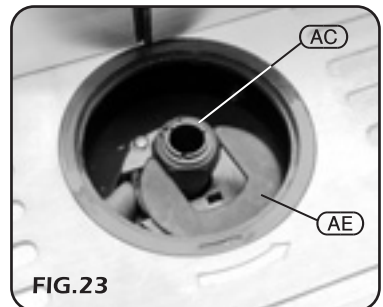

- **SWITCHING SPINDLE MOULDER ON/OFF (Fig.24):**

- Lift up protection cover (AF), press switch 'I' (AG) to turn spindle moulder on, or switch 'O' (AH) to turn spindle moulder off.

Note: If spindle moulder needs to be stopped in an emergency, press the red button (AI) found on the switch cover. If the emergency button is pressed, reset switch (AJ) must be pressed before the spindle moulder can be re-started.

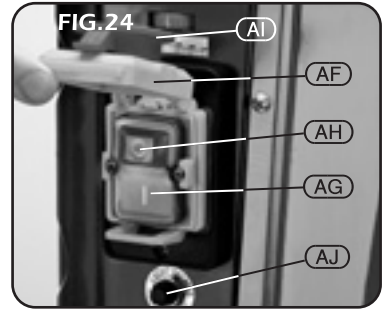

- **VARIABLE SPEED (Fig.25):**

- The spindle moulder is fitted with a variable speed switch (AK). The switch has 5 speeds detailed by numbers 1 - 5; '1' being the lowest speed and '5' the highest.



- **ROUTER BIT HEIGHT ADJUSTMENT (Fig.26):**

- The spindle moulder has a spindle travel of 0 - 40mm. The height can be changed by turning hand wheel (AL) left or right depending on whether the router bit height is to be increased or decreased. The height can be measured using measuring scale (AM).

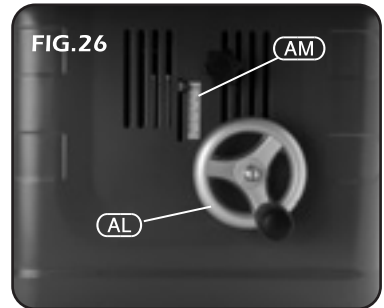

- **ADJUSTABLE LEFT FENCE PLATE (Fig.27):**

- The left sided rear fence plate (AN) can be adjusted forward and back by loosening locking knobs (AO) and manually sliding the fence plate to the desired position. The position of the plate can be determined using measuring scale (AP).

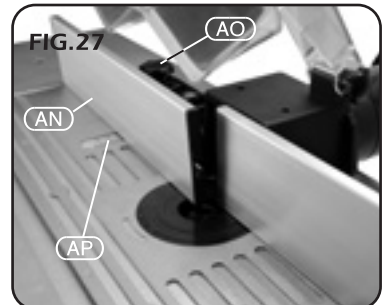

- **UPPER WORKPIECE GUIDE (Fig.28):**

- In order to use the upper workpiece guide (page 6, part 3) you first need to attach the upper guides support bracket (AQ) to the moulded rear guide.

Note: Before attaching the upper workpiece guide, you must first remove the router bit guard (page 6, part 9).

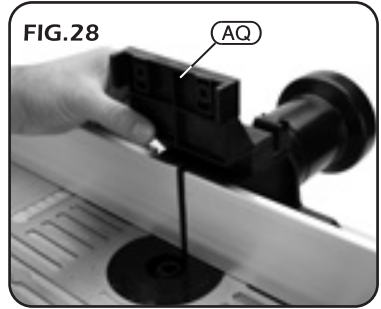

- **DUST EXTRACTION (Figs. 29 & 30):**

- The spindle moulder is supplied with a dust extraction adaptor (J). Without the adaptor the hose size is 35mm and when the adaptor is used the hose size is 100mm.

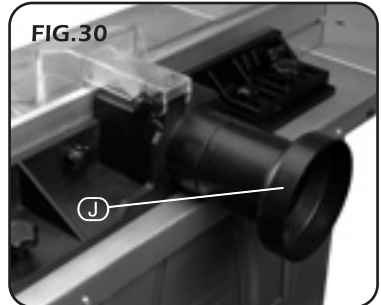

- At the end of the machine's working life, or when it can no longer be repaired, ensure that it is disposed of according to national regulations.
- Contact your local authority for details of collection schemes in your area.

In all circumstances:

- Do not dispose of power tools with domestic waste.
- Do not incinerate.
- Do not abandon in the environment.
- Do not dispose of WEEE* as unsorted municipal waste.



* Waste Electrical & Electronic Equipment.

- **DRAPER TOOLS LIMITED,**
Hursley Road, Chandler's Ford,
Eastleigh, Hampshire. SO53 1YF. U.K.

- **Helpline:** (023) 8049 4344
- **Sales Desk:** (023) 8049 4333
- **Internet:** www.draper.co.uk
- **E-mail:** sales@drapertools.com
- **Sales Fax:** (023) 8049 4209
- **General Enquiries:** (023) 8026 6355

- **Service/Warranty Repair Agent**
For aftersales servicing or warranty repairs, please
contact the Draper Tools Helpline for details of an
agent in your local area.

YOUR DRAPER STOCKIST

NW/JW220909

©Published by Draper Tools Limited.

No part of this publication may be reproduced, stored in a retrieval system or transmitted in any form or by any means, electronic, mechanical photocopying, recording or otherwise without prior permission in writing from Draper Tools Ltd.