

DRAPER[®]

INSTRUCTIONS FOR 230V 6L Oil Free Air Compressor

Stock No.24974 Part No.DA6/169

IMPORTANT: PLEASE READ THESE INSTRUCTIONS CAREFULLY TO ENSURE THE SAFE AND EFFECTIVE USE OF THIS PRODUCT.



CE

DRAPER[®]

GENERAL INFORMATION

These instructions accompanying the product are the original instructions. This document is part of the product, keep it for the life of the product passing it on to any subsequent holder of the product. Read all these instructions before assembling, operating or maintaining this product.

This manual has been compiled by Draper Tools describing the purpose for which the product has been designed, and contains all the necessary information to ensure its correct and safe use. By following all the general safety instructions contained in this manual, it will ensure both product and operator safety, together with longer life of the product itself.

All photographs and drawings in this manual are supplied by Draper Tools to help illustrate the operation of the product. Whilst every effort has been made to ensure the accuracy of information contained in this manual, the Draper Tools policy of continuous improvement determines the right to make modifications without prior warning.

1. TITLE PAGE

1.1 INTRODUCTION:

USER MANUAL FOR:

230V 6L OIL FREE AIR COMPRESSOR

Stock no. 24974

Part no. DA6/169

1.2 REVISIONS:

Date first published September 2012

As our user manuals are continually updated, users should make sure that they use the very latest version.

Downloads are available from: <http://www.drapertools.com/b2c/b2cmanuals.pgm>

DRAPER TOOLS LIMITED
HURSLEY ROAD
CHANDLER'S FORD
EASTLEIGH
HAMPSHIRE
SO53 1YFUK

WEBSITE: www.drapertools.com
PRODUCT HELPLINE: +44 (0) 23 8049 4344
GENERAL FAX: +44 (0) 23 8026 0784

1.3 UNDERSTANDING THIS MANUALS SAFETY CONTENT:

WARNING! Information that draws attention to the risk of injury or death.

CAUTION! Information that draws attention to the risk of damage to the product or surroundings.

1.4 COPYRIGHT © NOTICE:

Copyright © Draper Tools Limited.

Permission is granted to reproduce this publication for personal & educational use only. Commercial copying, redistribution, hiring or lending is prohibited.

No part of this publication may be stored in a retrieval system or transmitted in any other form or means without written permission from Draper Tools Limited.

In all cases this copyright notice must remain intact.

2. CONTENTS

2.1 CONTENTS

	PAGE CONTENT	PAGE
1	TITLE PAGE	
	1.1 INTRODUCTION	2
	1.2 REVISION HISTORY	2
	1.3 UNDERSTANDING THIS MANUAL	2
	1.4 COPYRIGHT NOTICE	2
2	CONTENTS	
	2.1 CONTENTS	3
3	GUARANTEE	
	3.1 GUARANTEE	4
4	INTRODUCTION	
	4.1 SCOPE	5
	4.2 SPECIFICATION	5
	4.3 HANDLING & STORAGE	5
5	HEALTH & SAFETY INFORMATION	
	5.1 GENERAL SAFETY INSTRUCTIONS FOR POWER TOOL USE	6
	5.2 ADDITIONAL SAFETY INSTRUCTIONS FOR SAFETY VALUES	8
	5.3 ADDITIONAL SAFETY INSTRUCTIONS FOR PRESSURE VESSELS	9A
	5.4 CONNECTION TO THE POWER SUPPLY	9A
6	TECHNICAL DESCRIPTION	
	6.1 IDENTIFICATION	10B
7	UNPACKING & CHECKING	
	7.1 PACKAGING	10A
	7.2 WHAT'S IN THE BOX	10A
8	PREPARING THE COMPRESSOR	
	8.1 LOCATION	11
	8.2 INITIAL STARTUP	11
9	OPERATION	
	9.1 BASIC COMPRESSOR OPERATION	12
	9.2 MOISTURE IN COMPRESSED AIR	12
	9.3 SAFETY VALVE	12
	9.4 THERMAL OVERLOAD PROTECTOR	13
	9.5 STORAGE	13
10	TROUBLESHOOTING	14
11	MAINTENANCE	15
	11.1 BASIC MAINTENANCE AND CHECKS	15
	11.2 DRAINING WATER FROM THE TANK	16
12	EXPLANATION OF SYMBOLS	
	12.1 EXPLANATION OF SYMBOLS	17
13	DISPOSAL	
	13.1 DISPOSAL	18
14	GLOSSARY	
	14.1 GLOSSARY	19
	DECLARATION OF CONFORMITY	ENCLOSED

3. GUARANTEE

3.1 GUARANTEE

Draper tools have been carefully tested and inspected before shipment and are guaranteed to be free from defective materials and workmanship.

Should the tool develop a fault, please return the complete tool to your nearest distributor or contact Draper Tools Limited, Chandler's Ford, Eastleigh, Hampshire, SO53 1YF. England. Telephone Sales Desk: (023) 8049 4333 or Product Helpline (023) 8049 4344.

A proof of purchase must be provided with the tool.

If upon inspection it is found that the fault occurring is due to defective materials or workmanship, repairs will be carried out free of charge. This guarantee period covering parts/labour is 12 months from the date of purchase except where tools are hired out when the guarantee period is ninety days from the date of purchase. This guarantee does not apply to normal wear and tear, nor does it cover any damage caused by misuse, careless or unsafe handling, alterations, accidents, or repairs attempted or made by any personnel other than the authorised Draper warranty repair agent.

Note: If the tool is found not to be within the terms of warranty, repairs and carriage charges will be quoted and made accordingly.

This guarantee applies in lieu of any other guarantee expressed or implied and variations of its terms are not authorised.

Your Draper guarantee is not effective unless you can produce upon request a dated receipt or invoice to verify your proof of purchase within the guarantee period.

Please note that this guarantee is an additional benefit and does not affect your statutory rights.

Draper Tools Limited.

4. INTRODUCTION

4.1 SCOPE

The compressor described in this manual is capable of supplying compressed air to a maximum pressure of 8bar. to operate pneumatic tools for a variety of applications including blowing, spraying and tyre inflating.

4.2 SPECIFICATION

Stock No.	24974
Part No.	DA6/169
Motor:	
Rated voltage	230V~50Hz
Rated frequency	50Hz
Rated input	1100W (1.5HP)
Revolutions per minute (no load)	2,850min-1
Maximum working pressure	116psi (8bar)
Air displacement	6.0cfm (161L/min)
Free air delivery	3.46cfm (98L/min)
Receiver capacity.....	6 Litres
Sound power level	97dB(A)
Sound pressure level	71.5dB(A)
*Single value noise level.....	93dB(A)
Dimensions (LxWxH)	420x220x520mm
Weight	14kg

4.3 HANDLING & STORAGE

This compressor is designed to be moved to different locations. Ensure it is always operated on a level surface. When in transit care should be taken not to cause damage particularly to gauges and air lines.

*A-Weighed sound power level in accordance to 2000/14/EC

5. HEALTH & SAFETY INFORMATION

5.1 GENERAL SAFETY INSTRUCTIONS FOR POWER TOOL USE

When using any type of power tool there are steps that should be taken to make sure that you, as the user, remain safe.

Common sense and a respect for the tool will help reduce the risk of injury.

Read the instruction manual fully. Do not attempt any operation until you have read and understood this manual.

Most important you must know how to safely start and stop this machine, especially in an emergency.

Keep the work area tidy and clean. Attempting to clear clutter from around the machine during use will reduce your concentration. Mess on the floor creates a trip hazard. Any liquid spilt on the floor could result in you slipping.

Find a suitable location. If the machine is bench mounted; the location should provide good natural light or artificial lighting as a replacement. Avoid damp and dust locations as it will have a negative effect on the machine's performance.

If the machine is portable; do not expose the tool to rain. In all cases do not operate power tools near any flammable materials.

Beware of electric shock. Avoid contact with earthed surfaces; because they can conduct electricity if there is an electrical fault with the power tool. Always protect the power cable and route it away from danger.

Keep bystanders away. Children, onlookers and passers by must be restricted from entering the work area for their own protection. The barrier must extend a suitable distance from the tool user.

Unplug and house all power tools that are not in use. A power tool should never be left unattended while connected to the power supply. They must be housed in a suitable location, away locked up and from children.

Do not overload or misuse the tool. All tools are designed for a purpose and are limited to what they are capable of doing. Do not attempt to use a power tool (or adapt it in any way) for an application it is not designed for. Select a tool appropriate for the size of the job. Overloading a tool will result in tool failure and user injury: This covers the use of accessories.

Dress properly. Loose clothing, long hair and jewellery are all dangerous because they can become entangled in moving machinery: This can also result in parts of body being pulled into the machine.

Clothing should be close fitted, with any long hair tied back and jewellery and neck ties removed. Footwear must be fully enclosed and have a nonslip sole.

5. HEALTH & SAFETY INFORMATION

Wear personal protective equipment (PPE). Dust, noise, vibration and **swarf** can all be dangerous if not suitably protected against. If the work involving the power tool creates dust or fumes; wear a dust mask. Vibration to the hand, caused by operating some tools for longer periods must be protected against. Wear vibration reducing gloves and allow long breaks between uses. Protect against dust and **swarf** by wearing approved safety goggles or a face shield. These are some of the more common hazards and preventions; however, always find out what hazards are associated with the machine/work process and wear the most suitable protective equipment available.

Do not breathe contaminated air. If the work creates dust or fumes; connect the machine (if possible) to an extraction system either locally or remotely. Working outdoors can also help if possible.

Move the machine as instructed. If the machine is hand held, do not carry it by the power supply cable. If the product is heavy; employ a second or third person to help move it safely or use a mechanical device. Always refer to the instructions for the correct method.

Do not overreach. Extending your body too far can result in a loss of balance and you falling. This could be from a height or onto a machine and will result in injury.

Maintain your tools correctly. A well maintained tool will do the job safely. Replace any damaged or missing parts immediately with original parts from the manufacturer. As applicable; keep blades sharp; moving parts clean, oiled or greased; handles clean; and emergency devices working.

Wait for the machine to stop. Unless the machine is fitted with a safety brake; some parts may continue to move due to momentum. Wait for all parts to stop; then unplug it from the power supply before making any adjustments, carrying out maintenance operations or just finishing using the tool.

Remove and check setting tools. Some machinery requires the use of additional tools or keys to set, load or adjust the power tool. Before starting the power tool always check to make certain they have been removed and are safely away from the machine.

Prevent unintentional starting. Before plugging any machine in to the power supply, make sure the switch is in the OFF position. If the machine is portable; do not hold the machine near the switch and take care when putting the machine down; that nothing can operate the switch.

Carefully select an extension lead. Some machines are not suitable for use with extension leads. If the tool is designed for use outdoors; use an extension lead also suitable for that environment. When using an extended lead, select one capable of handling the current (amps) drawn by the machine in use. Fully extend the lead regardless of the distance between the power supply and the tool. Excess current (amps) and a coiled extension lead will both cause the cable to heat up and can result in fire.

Concentrate and stay alert. Distractions are likely to cause an accident. Never operate a power tool if you are under the influence of drugs (prescription or otherwise), including alcohol or if you are feeling tired. Being disorientated will result in an accident.

5. HEALTH & SAFETY INFORMATION

Have this tool repaired by a qualified person. This tool is designed to conform to the relevant international and local standards and as such should be maintained and repaired by someone qualified; using only original parts supplied by the manufacturer: This will ensure the tool remains safe to use.

5.2 ADDITIONAL SAFETY INSTRUCTIONS FOR SAFETY VALVES

Information: The safety valves are designed and constructed for use exclusively with compressed air, free from impurities. The materials used in construction are suitable for operating the valve at the rated pressure and temperatures. The Viton or NBR gasket conserves the resistance characteristics, even in prolonged use. The valve caulking impedes calibration modification; tampering with the valve and/or changing the constructor's calibration is forbidden.

Installation: Valve installation must be performed exclusively by technically prepared persons, who are responsible and in good health. Checking the integrity of the valve before installation is obligatory. Also, check that the valve pressure is no greater than the operating pressure of the tank or of the system to protect. Check that the discharge flow rate of the valve is greater than the quantity of the air to discharge. The safety valve must be positioned directly on the tank in a vertical position, in a dry, accessible place protected against the weather and far away from liquids or condensation. It must be positioned so as to have sufficient space all around for correct air discharge, without causing damage to persons and/or things. The valve rod must therefore be free in its movement when discharging. The connection between the valve and the part to be protected must be free from all kinds of choking and be as short as possible so as not to reduce the discharge flow rate of the valve itself. The connection passage area must be greater than the valve orifice area. During installation, screw on the valve with a torque spanner using the hexagonal part of the body. Apply a maximum torque of 30Nm, paying attention not to cause any deformation; using pincers, pliers, hammers or tools other than a hexagonal spanner is forbidden. Check the inlet hole and the shutter are not blocked by glue, teflon or similar materials that could bind the shutter or other functional components. If the valve is replaced, the compressor air contained in the system must be discharged first. We decline all responsibility for damage caused to persons and/or things due to failure to observe these instructions.

Maintenance and inspection: The valve must not be subject to knocks which may cause deformities. It is obligatory for qualified technicians to make sure that the safety valve functions correctly at least once a year. Valves equipped with a ring must be tested while pressurised to between 80-90% of the calibration value. Pull the ring and release immediately. During the test the valve must definitely open and discharge the air and re-close immediately when the ring is released. It is absolutely necessary to carry out this procedure with the utmost caution because this type of job can be dangerous if adequate safety measures are not taken; wear goggles, a head set and anything else necessary to protect against noise, jets of air, etc. which may be discharged from the valve.

5. HEALTH & SAFETY INFORMATION

5.3 ADDITIONAL SAFETY INSTRUCTIONS FOR PRESSURE VESSELS

- This pressure tank is mainly intended for static use. It can only be charged with natural air within temperature and pressure limits as specified on the manufacturer's plate and declaration of conformity.
- Ensure that tank safety and control devices are efficient and flawless. When replaced, the tank should not be under pressure.
- Drain the condensation off the tank every day.
- Check for signs of inner corrosion at regular intervals. Tank walls should have a minimum thickness of 1.0 – 2.0mm.
- Any kind of welding to the tank is forbidden.
- The user shall comply with laws on pressure vessel operation in force in the country in which the tank is operated.
- The construction is mainly effected for permanent load by internal pressure. Cyclic loads are not considered, only for a range of 10% PS.

5.4 CONNECTION TO THE POWER SUPPLY

Make sure the power supply information on the machine's rating plate are compatible with the power supply you intend to connect it to.

This compressor comes supplied with a UK standard 3 pin plug fitted. It is designed for connection to a domestic power supply rated at 230V AC.

Because it is constructed mostly of metal parts, it is a Class 1 machine; meaning, it must have an earth connection in the power supply. This is to prevent electrocution in the event of a failure.

Apart from replacing the fuse in the plug, no other electrical work is recommended on this compressor.

Blank page

6. TECHNICAL DESCRIPTION

6.1 IDENTIFICATION



- ① Carry handle
- ② Pressure switch On/Off button
- ③ Pressure regulator
- ④ Air outlet quick connector
- ⑤ Pressure switch
- ⑥ Tank pressure gauge
- ⑦ Air outlet pressure gauge

- ⑧ Safety valve
- ⑨ Drain cock
- ⑩ Air filter.
- ⑪ Tank
- ⑫ 4 x Rubber feet
- ⑬ Motor

7. UNPACKING & CHECKING

7.1 PACKAGING

Carefully remove the compressor from the packaging and examine it for any sign of damage that may have happened during shipping. Lay the contents out and check them against the parts shown below. If any part is damaged or missing; please contact the Draper Helpline (the telephone number appears on the Title page) and do not attempt to use the compressor.

The packaging material should be retained at least during the guarantee period: in case the machine needs to be returned for repair.

Warning! Some of the packaging materials used may be harmful to children. Do not leave any of these materials in the reach of children.

If any of the packaging is to be thrown away, make sure they are disposed of correctly; according to local regulations.

7.2 WHAT'S IN THE BOX?

As well as the compressor; there may be several parts not fitted or attached to it.

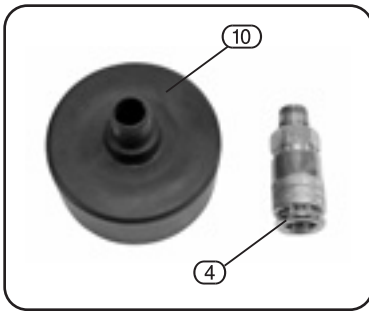

⑩ Air filter.

④ Air outlet quick connector.

8. PREPARING THE COMPRESSOR

NOTE: Remove the plug from the socket before carrying out adjustment, servicing or maintenance.

8.1 LOCATION AND ASSEMBLY - FIG. 1

It is extremely important to install the compressor in a clean, well ventilated area where the surrounding air temperature will not be more than 40°C. A minimum clearance of 500mm between the compressor and a wall is required.

Fitting the air filter:

Remove the transit bung from the top of the head and screw the air filter (10) into the filter connection.

In addition to pneumatic air tools, your compressor may be connected to several accessories suitable for blowing, washing and spraying. For technical specifications and detailed instructions, please refer to the instructions provided for the individual accessory.

When the installation procedure is complete, the compressor is ready for use. Make sure the pressure switch button (2) is positioned "OFF".

Switch the pressure switch button to the "ON" position to start the compressor.

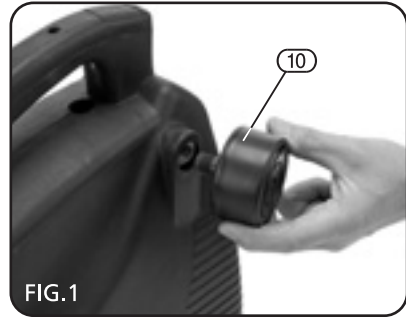

8.4 INITIAL STARTUP – FIGS. 2-3

- Insert a euro connector into the air outlet connector (4) and open the regulator (3) fully.
- Turn the compressor on by pulling the pressure switch On/Off button (2) up.
- Run the compressor for 30 minutes allowing the pressure to escape.
- Turn the regulator dial fully counter-clockwise allowing pressure to build up. Once the maximum pressure is reached, the pressure switch will automatically turn the machine off.
- Turn the compressor off, by pressing the pressure switch On/Off button down and open the regulator valve allowing the air to escape.

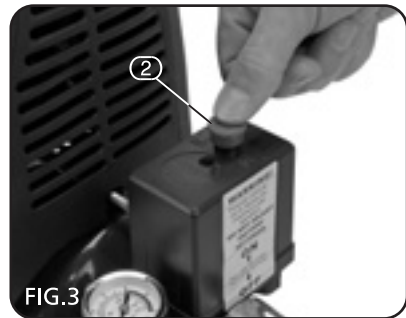
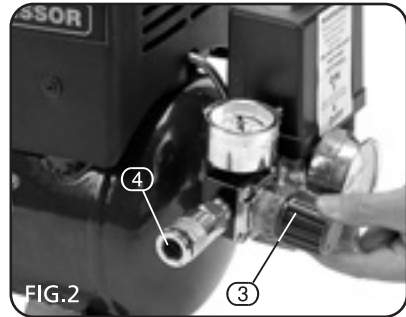

9. OPERATION

9.1 BASIC COMPRESSOR OPERATION

– FIG. 4

- Connect the air line to the compressor by pulling back the collar (4.1) on the air outlet quick coupling (4) and inserting the corresponding air coupling fitted on the air line. Release the collar so it slides back in place to secure the air coupling.
- Turn the air regulator clockwise to its lowest setting and turn on the compressor by lifting the pressure switch On/Off button (2) upwards.
- Once the compressor has reached maximum pressure, open the regulator valve (3) to the desired pressure on the air outlet regulator gauge (7).

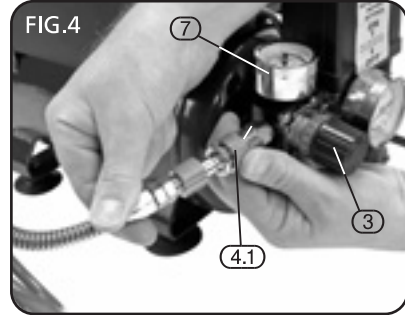

9.2 MOISTURE IN COMPRESSED AIR

Moisture in compressed air will form into droplets as it comes from an air compressor pump. When humidity is high or when a compressor is in continuous use for an extended period of time, this moisture will collect in the tank. When using a paint spray gun or sandblast gun, this water will be carried from the tank through the hose, and out of the gun as droplets mixed with the spray material.

IMPORTANT: This condensation will cause water spots in a paint job, especially when spraying other than water based paints. If sandblasting, it will cause the sand to case and clog the gun rendering it ineffective. A filter in the air line, located as near to the gun as possible, will help eliminate this moisture.

9.3 SAFETY VALVE – FIG. 5

WARNING: DO NOT REMOVE OR ATTEMPT TO ADJUST THE SAFETY VALVE!

This valve (8) should be checked under pressure occasionally by pulling the ring (8.1) by hand. If air leaks after the ring has been released, or valve is stuck, it **MUST** be replaced.

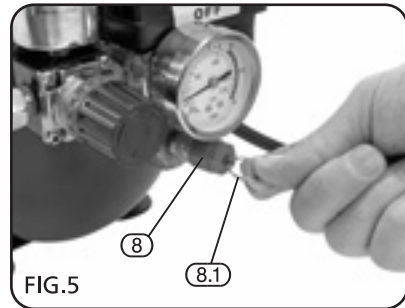

9. OPERATION

9.4 THERMAL OVERLOAD PROTECTOR

CAUTION: THIS COMPRESSOR IS EQUIPPED WITH AN AUTOMATIC RESET THERMAL OVERLOAD PROTECTOR, WHICH WILL SHUT OFF THE MOTOR IF IT BECOMES OVERHEATED.

If thermal overload protector shuts motor OFF frequently, look for the following causes.

- Low voltage.
- Clogged air filter.
- Lack of proper ventilation.

CAUTION: IF THE THERMAL OVERLOAD PROTECTOR IS ACTUATED, THE MOTOR MUST BE ALLOWED TO COOL DOWN BEFORE START-UP IS POSSIBLE. THE MOTOR WILL AUTOMATICALLY RESTART WITHOUT WARNING IF LEFT PLUGGED INTO ELECTRICAL OUTLET AND UNIT IS TURNED ON.

9.5 STORAGE

- When not in use, store hose and compressor in a cool dry place.
- Drain tank of moisture.
- Disconnect hose and hang open ends down to allow any moisture to drain.

10. TROUBLESHOOTING

FAULT	POSSIBLE CAUSE	REMEDY
Compressor will not run.	<ol style="list-style-type: none"> 1. No electrical power. 2. Blown fuse. 3. Breaker open. 4. Thermal overload open. 5. Pressure switch bad. 	<ol style="list-style-type: none"> 1. Plugged in? Check fuse/breaker or motor overload. 2. Replace blown fuse. 3. Reset, determine cause of problem. 4. Motor will restart when cool. 5. Replace.
Motor operating, but cannot run or runs slowly.	<ol style="list-style-type: none"> 1. Defective check valve or unloaded. 2. Poor contacts, line voltage low. 3. Shortened or open motor winding. 	<ol style="list-style-type: none"> 1. Replace or repair. 2. Check connections, eliminate extension cork if used, check circuit with voltmeter. 3. Replace motor. <p>Danger! Do not disassemble check valve with air in tank; bleed tank.</p>
Fuses blow/circuit breaker trips repeatedly. Caution! Never use an extension cord with this product.	<ol style="list-style-type: none"> 1. Incorrect size fuse, circuit overloaded. 2. Defective check valve or unloaded. 	<ol style="list-style-type: none"> 1. Check for proper fuse, use time-delay fuse. Disconnect other electrical appliances from circuit or operate compressor on its own branch circuit. 2. Replace or repair. <p>Danger! Do not disassemble check valve with air in tank; bleed tank.</p>
Thermal overload protector cuts out repeatedly.	<ol style="list-style-type: none"> 1. Low voltage. 2. Clogged air filter. 3. Lack of proper ventilation/room temperature too high. 4. Check valve malfunction. 5. Compressor valves failed. 	<ol style="list-style-type: none"> 1. Eliminate extension cord, check with voltmeter. 2. Clean filter (see maintenance section). 3. Move compressor to well ventilated area. 4. Replace. 5. Replace valve assembly. <p>Danger! Do not disassemble check valve with air in tank; bleed tank.</p>
Knocks, rattles, excessive vibration.	<ol style="list-style-type: none"> 1. Loose bolts, tank not level. 2. Defective bearing on eccentric or motor shaft. 3. Cylinder or piston ring is worn or scored. 	<ol style="list-style-type: none"> 1. Tighten bolts, shim tank to level position. 2. Replace. 3. Replace or repair as necessary.

10. TROUBLESHOOTING

FAULT	POSSIBLE CAUSE	REMEDY
Tank pressure drops when compressor shuts off.	<ol style="list-style-type: none"> 1. Loose drain cock. 2. Check valve leaking. 3. Loose connections at pressure switch or regulator. 	<ol style="list-style-type: none"> 1. Tighten. 2. Disassemble check valve assembly, clean or replace. 3. Check all connections with soap and water solution and tighten.
Compressor runs continuously and air output is lower than normal/low discharge pressure.	<ol style="list-style-type: none"> 1. Excessive air usage, compressor too small. 2. Clogged intake filter. 3. Air leaks in piping (on machine or in outside system). 4. Broken inlet valves. 5. Piston ring worn. 	<ol style="list-style-type: none"> 1. Decrease usage or purchase unit with higher air delivery (SCFM). 2. Clean or replace. 3. Replace leaking components or tighten as necessary. 4. Replace compressor valves. 5. Replace piston and cylinder.
Excessive moisture in discharge air.	<ol style="list-style-type: none"> 1. Excessive water in tank. 2. High humidity. 	<ol style="list-style-type: none"> 1. Drain tank. 2. Move to area of less humidity; use air line filter. <p>Note: Water condensation is not caused by compressor malfunction.</p>
Compressor runs continuously and safety valve opens as pressure rises.	<ol style="list-style-type: none"> 1. Defective pressure switch. 2. Defective safety valve. 	<ol style="list-style-type: none"> 1. Replace switch. 2. Replace safety valve with genuine replacement part.
Excessive starting and stopping (auto start).	Excessive condensation in tank	Drain more often.
Air leaking from unloader on pressure switch.	Check valve stuck in an open position.	Remove and replace check valve. Danger! Do not disassemble check valve with air in tank; bleed tank.

11. MAINTENANCE

11.1 BASIC MAINTENANCE AND CHECKS – FIG. 6

NOTE: Remove the plug from the socket before carrying out adjustment, servicing or maintenance.

In order to maintain the compressor to its optimum, periodical service checks must be carried out routinely. Allowances should be made to adjust the time scale for machines in occasional service with the exception of the safety valve which must be inspected by a qualified service agent every 12 months regardless of use.

NOTE: Where necessary, ear defenders and safety goggles must be worn.

Daily checks:

- Before every use check the airline/regulator/seperator.
- After every use adjust the line pressure back to zero.

Monthly checks:

- Remove the foam air filter element (10) for cleaning or renew if necessary.
 - Rinse the filter with water and soap. Make certain the element is completely dry prior to re-fitting.

The cleaning/replacement of the air filter must be carried out more frequently if the compressor is operating in a dusty environment.

The motor must be correctly ventilated during operation. For this reason avoid blocking the air inlets. After use disconnect the compressor from the power supply and vacuum the ventilation slots.

If replacement of the supply cord becomes necessary, this will need to be completed by the manufacturer or an appointed agent in order to avoid potential safety hazards.

WARNING: NEVER ATTEMPT TO RUN THE COMPRESSOR WITHOUT THE FILTER ELEMENT FITTED AS DUST OR FOREIGN BODIES CAN ENTER THE PUMP UNIT RESULTING IN SERIOUS DAMAGE.

11.2 DRAINING WATER FROM THE TANK – FIG. 7

The drain cock (9) is located on the bottom of the tank. Use this valve to drain moisture from the tank daily to reduce the risk of corrosion.

- Reduce the tank pressure below 10psi.
- Drain moisture from the tank by opening the drain cock located underneath the tank.

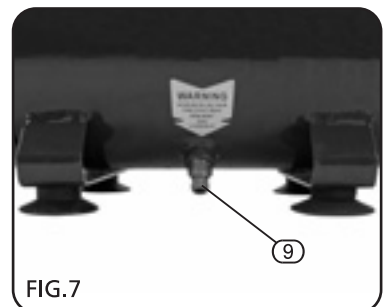

12. EXPLANATION OF SYMBOLS

12.1 EXPLANATION OF SYMBOLS



Warning!
Wear dust mask.



Warning!
Read the instruction manual



Warning!
Wear goggles.



Warning!
Wear ear defenders.



WEEE
Do not dispose of Waste Electrical
& Electronic Equipment in with
domestic rubbish

13. DISPOSAL

13.1 DISPOSAL

- At the end of the machine's working life, or when it can no longer be repaired, ensure that it is disposed of according to national regulations.
- Contact your local authority for details of collection schemes in your area.

In all circumstances:

- Do not dispose of power tools with domestic waste.
- Do not incinerate.
- Do not abandon in the environment.
- Do not dispose of WEEE* as unsorted municipal waste.



* Waste Electrical & Electronic Equipment.

14. GLOSSARY

14.1 GLOSSARY

Alphabetical list of words relating to this manual

Check valve	A one-way valve that allows air to enter the tank but prevents air in the tank from flowing back into the compressor pump.
Drain cock	This valve is located on the bottom of the tank. Use this to drain moisture from the tank to reduce the risk of corrosion.
Regulator	The regulator controls the amount of air pressure released at the hose outlet.
Safety valve	The valve automatically releases air if the tank pressure exceeds maximum pressure.

- **DRAPER TOOLS LIMITED,**
Hursley Road, Chandler's Ford,
Eastleigh, Hampshire. SO53 1YF. U.K.

- **Helpline:** (023) 8049 4344
- **Sales Desk:** (023) 8049 4333
- **Internet:** www.draper.co.uk
- **E-mail:** sales@drapertools.com
- **Sales Fax:** (023) 8049 4209
- **General Enquiries:** (023) 8026 6355

- **Service/Warranty Repair Agent**
For aftersales servicing or warranty repairs, please
contact the Draper Tools Helpline for details of an
agent in your local area.

YOUR DRAPER STOCKIST