

THE TOOL COMPANY

# WET & DRY BENCH GRINDER

■ STOCK No.31235

■ PART No.GWD205A

## • INSTRUCTIONS •

**IMPORTANT:** PLEASE READ THESE INSTRUCTIONS CAREFULLY TO ENSURE THE SAFE AND EFFECTIVE USE OF THIS TOOL.

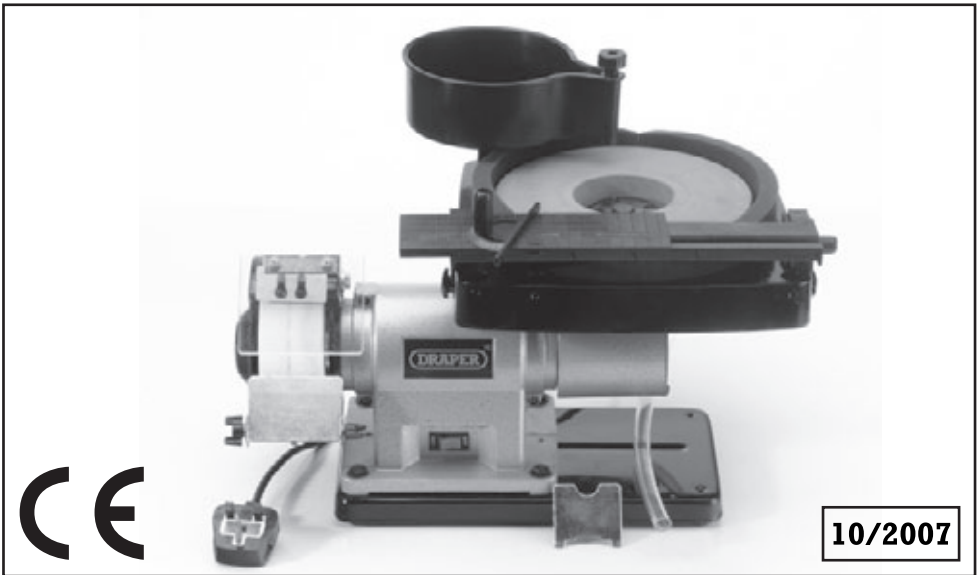

10/2007

## GENERAL INFORMATION

This manual has been compiled by Draper Tools and is an integrated part of the product with which it is enclosed and should be kept with it for future references.

This manual describes the purpose for which the product has been designed and contains all the necessary information to ensure its correct and safe use. We recommend that this manual is read before any operation or, before performing any kind of adjustment to the product and prior to any maintenance tasks. By following all the general safety instructions contained in this manual, it will ensure both product and operator safety, together with longer life of the product itself.

All photographs and drawings in this manual are supplied by Draper Tools to help illustrate the operation of the product.

Whilst every effort has been made to ensure accuracy of information contained in this manual, the Draper Tools policy of continuous improvement determines the right to make modifications without prior warning.



THE TOOL COMPANY

# WET & DRY BENCH GRINDER

■ STOCK No.31235

■ PART No.GWD205A

## CONTENTS:

|                                    |       |
|------------------------------------|-------|
| Contents/Declaration .....         | 1     |
| Specification/Guarantee .....      | 2     |
| Power Supply .....                 | 3     |
| General Safety Instructions .....  | 4     |
| Getting to Know Your Grinder ..... | 5     |
| Assembly .....                     | 6 & 7 |
| Operation & Use .....              | 8     |
| Optional Accessories .....         | 9     |



## DECLARATION OF CONFORMITY

We  
Draper Tools Ltd. Hursley Road, Chandler's Ford, Eastleigh, Hampshire.  
SO53 1YF. England.

Declare under our sole responsibility that the product:

**Stock No:-** 31235.

**Part No:-** GWD205A.

**Description:-** WET & DRY BENCH GRINDER

To which this declaration relates is in conformity with the following directive(s)  
98/37/EC, 73/23/EEC & 89/336/EEC

With reference to: EN61029-1.,:2000 & prEN61029-2-4:2001

JOHN DRAPER  
Managing Director

23/09/2002



# SPECIFICATION

The Draper Tools policy of continuous improvement determines the right to change specification without notice.

- Stock No. .... 31235
- Part No. .... GWD205A
- Whetstone wheel dia ..... 200mm (8")
- Whetstone wheel bore ..... 80mm (3")
- Dry stone wheel dia ..... 125mm (5")
- Dry tone wheel bore ..... 12.7mm (1/2")
- Speeds:
  - Whetstone wheel ..... 320rpm
  - Dry stone wheel ..... 2850rpm
- Motor ..... 350W (1/2HP)
- Weight nett/gross ..... 10/11kg
- Machine dimensions (approx) ..... 460x320x300mm

**ALWAYS WEAR GLOVES AND EYE PROTECTION**



# GUARANTEE

Draper Tools have been carefully tested and inspected before shipment and are guaranteed to be free from defective materials and workmanship for a period of 12 months from the date of purchase except where tools are hired out when the guarantee period is ninety days from the date of purchase.

Should the machine develop any fault, please return the complete tool to your nearest authorized warranty repair agent or contact Draper Tools Limited, Chandler's Ford, Eastleigh, Hampshire, SO53 1YF. England. Telephone: (023) 8026 6355.

If upon inspection it is found that the fault occurring is due to defective materials or workmanship, repairs will be carried out free of charge. This guarantee does not apply to normal wear and tear, nor does it cover any damage caused by misuse, careless or unsafe handling, alterations, accident, or repairs attempted or made by any personnel other than the authorised Draper warranty repair agent.

This guarantee applies in lieu of any other guarantee expressed or implied and variations of its terms are not authorised.







Your Draper guarantee is not effective unless you can produce upon request a dated receipt or invoice to verify your proof of purchase within the 12 month period.

Please note that this guarantee is an additional benefit and does not affect your statutory rights.

Draper Tools Limited.

# POWER SUPPLY

## CONNECTING YOUR MACHINE TO THE POWER SUPPLY: (230V ONLY)

To eliminate the possibility of an electric shock your machine has been fitted with a BS approved, non rewirable moulded plug and cable which incorporates a fuse, the value of which is indicated on the pin face of the plug. If the plug is marked with the  symbol and the fuse needs replacing, an  approved BS1362 fuse must be used of the same amp rating. If the plug is not  marked, a fuse with the  symbol,  BS Kitemark, or both  and  BS Kitemark, of the same amp rating should be used.

The fuse cover is detachable, never use the plug with the cover omitted. If a replacement fuse cover is required, ensure it is the same colour as that visible on the pin face of the plug (i.e. red). Fuse covers are available from your Draper Tools stockist.

If the fitted plug is not suitable, it should be cut off and destroyed. \*The end of the cable should now be suitably prepared and the correct type of plug fitted. See below.

### \*WARNING:

A plug with bare flexible wires exposed is hazardous if engaged in a live power socket outlet.

### WARNING: THIS APPLIANCE MUST BE EARTHED.

The mains lead is coloured Green and Yellow - Earth, Blue - Neutral and Brown - Live. As these colours may not correspond with the coloured markings identifying the terminals in your plug, proceed as follows:

The wire which is coloured green and yellow must be connected to the terminal in your plug marked with the letter 'E' or by the earth symbol  or coloured green or green and yellow.

The wire which is coloured blue must be connected to the terminal which is marked with the letter 'N' or coloured black or blue.

The wire which is coloured brown must be connected to the terminal which is marked with the letter 'L' or coloured red or brown.

### EXTENSION LEAD CHART:

Extension lead sizes shown assure a voltage drop of not more than 5% at rated load of tool.

| Ampere rating<br>(on Name plate) | 3                         | 6    | 10   | 13   |
|----------------------------------|---------------------------|------|------|------|
| Extension cable length (Metres)  | Wire Size mm <sup>2</sup> |      |      |      |
| 7.5                              | 0.75                      | 0.75 | 1.0  | 1.25 |
| 15                               | 0.75                      | 0.75 | 1.0  | 1.5  |
| 22.5                             | 0.75                      | 0.75 | 1.0  | 1.5  |
| 30                               | 0.75                      | 0.75 | 1.25 | 1.5  |
| 45                               | 0.75                      | 0.75 | 1.5  | 2.5  |



# GENERAL SAFETY INSTRUCTIONS FOR POWER TOOLS

## WARNING:

Please read the following instructions carefully, failure to do so could lead to serious personal injury. When using electric tools, basic safety precautions, including the following, should always be followed to reduce the risk of fire, electric shock and personal injury. Read all these instructions before operating this product and save these instructions.

## IMPORTANT:

Draper Tools Limited recommends that this machine should not be modified or used for any application other than that for which it was designed. If you are unsure of its relative applications do not hesitate to contact us in writing and we will advise you.

1. **KNOW YOUR POWER TOOL**  
Read and understand the owner's manual and labels affixed to the tool. Learn its application and limitations as well as the specific potential hazards peculiar to this tool.
2. **KEEP WORK AREA CLEAN**  
Cluttered areas and benches invite accidents. Floors must not be slippery due to oil or sawdust.
3. **AVOID DANGEROUS ENVIRONMENTS**  
Do not use power tools in damp or wet locations, or expose them to rain. Keep work area well lit. Provide adequate space surrounding the work area. Do not use in environments with a potentially explosive atmosphere.
4. **KEEP CHILDREN AWAY**  
All visitors should be kept a safe distance from work area.
5. **STORED TOOLS**  
When not being used, all tools should be stored in a dry, locked cupboard and out of the reach of children.
6. **WEAR PROPER CLOTHING**  
Do not wear loose clothing, neckties or jewellery (rings, wristwatches) to catch in moving parts. NONSLIP footwear is recommended. Wear protective hair covering to contain long hair. Roll long sleeves above the elbow.
7. **USE SAFETY GOGGLES (Head Protection)**  
Wear CE approved safety goggles at all times. Normal spectacles only have impact resistant lenses, they are NOT safety glasses. Also, use face or dust mask if application is dusty and ear protectors (plugs or muffs) during extended periods of operation.
8. **NOISE LEVELS**  
Some types of machines may have high noise levels when working. In such cases ear protection must be worn.
9. **VIBRATION LEVELS**  
Hand held power tools produce different vibration levels. You should always refer to the specifications and relevant Health and Safety guide.
10. **DUST EXTRACTION**  
If your tool is fitted with a dust extraction fitting, always ensure that it is connected and being used with a dust extractor. Vacuum cleaners can be used if suitable for the material being extracted.
11. **PROTECT YOURSELF FROM ELECTRIC SHOCK**  
When working with power tools, avoid contact with any earthed items (e.g. pipes, radiators, hobs and refrigerators, etc.). If you are using a power tool in extreme conditions (e.g. high humidity or generating metal dust), always use an RCD (residual current device) at the power socket.
12. **STAY ALERT**  
Always watch what you are doing and use common sense. Do not operate a power tool when you are tired or under the influence of alcohol or drugs.
13. **WHEN WORKING OUT OF DOORS**  
Only use extension leads designed for that purpose.
14. **ACCESS TO MAINS SOCKET**  
If a stationary machine is fitted with a moulded plug and cable, the machine should not be positioned so that access to the mains socket is restricted.
15. **DISCONNECT POWER TO THE TOOL**  
When not in use, before servicing and when changing accessories such as cutters, etc.
16. **AVOID ACCIDENTAL STARTING**  
Make sure the switch is in the OFF position before plugging the machine into the power supply.
17. **NEVER LEAVE MACHINE RUNNING UNATTENDED**  
Turn power off. Do not leave machine until it comes to a complete stop.
18. **DO NOT ABUSE THE CORD**  
Never carry the tool by the power cable or pull it from the socket. Keep the power cable away from heat, oil and sharp edges. If the supply cord is damaged, it must be replaced by the manufacturer or its service agent or a similarly qualified person in order to avoid hazard.
19. **NEVER STAND ON TOOL**  
Serious injury could occur if the tool is tipped or if the cutting tool is accidentally contacted. Do not store materials above or near the tool, so that it is necessary to stand on the tool to reach them.
20. **CHECK DAMAGED PARTS**  
Before further use of the tool, a guard or other part that is damaged should be carefully checked to determine that it will operate properly and perform its intended function. Check for alignment of moving parts, free running of moving parts, breakage of parts, mounting and any other conditions that may affect its operation. A guard or other part that is damaged should be repaired properly or replaced by an authorized service centre unless otherwise indicated in this instruction manual. Have defective switches replaced by an authorized service facility. Do not use the tool if the switch does not turn it on and off.
21. **KEEP GUARDS IN PLACE**  
And in working order.
22. **MAINTAIN TOOLS WITH CARE**  
Keep tools sharp and clean for the best and safest performance. Follow instructions for lubricating and changing accessories. All extension cables must be checked at regular intervals and replaced if damaged. Always keep the hand grips on the tool clean, dry and free of oil and grease.
23. **USE RECOMMENDED ACCESSORIES**  
Consult the owners manual for recommended accessories. Follow the instructions that accompany the accessories. The use of improper accessories may cause hazards.
24. **REMOVE ADJUSTING KEYS AND WRENCHES**  
Form a habit of checking to see that keys and adjusting wrenches are removed from the tool before turning it on.
25. **SECURE WORK**  
Use clamps or a vice to hold work. This frees both hands to operate the tool.
26. **DO NOT OVERREACH**  
Keep proper footing and balance at all times.
27. **USE RIGHT TOOL**  
Do not force the tool or attachment to do a job for which it was not designed.
28. **DO NOT FORCE TOOL**  
It will do the job better and safer at the rate for which it was designed.
29. **DIRECTION OF FEED**  
Feed work into a blade or cutter against the direction of rotation of the blade or cutter only.
30. **WHEN DRILLING OR SCREWING INTO WALLS**  
Always make sure there is no danger of hitting any hidden power cables, water or gas pipes in the wall.
31. **HAVE YOUR TOOL REPAIRED BY A QUALIFIED PERSON**  
This electric tool is in accordance with the relevant safety requirements. Repairs should only be carried out by qualified persons using original spare parts, otherwise this may result in considerable danger to the user.

## IMPORTANT NOTE:

Residual Risk. Although the safety instructions and operating manuals for our tools contain extensive instructions on safe working with power tools, every power tool involves a certain residual risk which can not be completely excluded by safety mechanisms. Power tools must therefore always be operated with caution!

## GETTING TO KNOW YOUR WET & DRY BENCH GRINDER

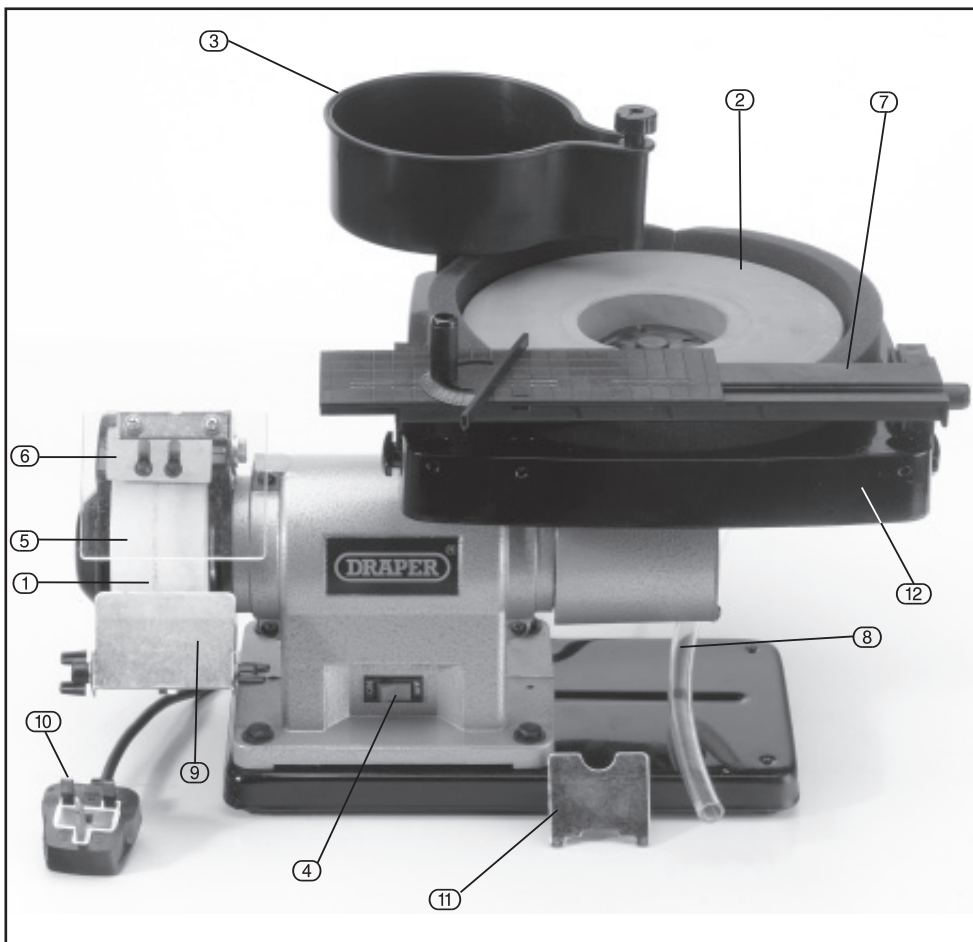

- |                      |                          |                           |
|----------------------|--------------------------|---------------------------|
| ① Grinding wheel     | ⑤ Eyeshield              | ⑨ Tool rest               |
| ② Whetstone wheel    | ⑥ Spark deflector        | ⑩ BS moulded plug & cable |
| ③ Reservoir with tap | ⑦ Honing guide/tool rest | ⑪ Holding tool            |
| ④ On/Off switch      | ⑧ Drainage hose          | ⑫ Water tray              |

**UNPACKING:** After removing the packing material, make sure the product is in perfect condition and that there are no visible damaged parts. If in doubt, do not use the wet & dry bench grinder and contact the dealer from whom it was purchased. The packaging materials (plastic bags, polystyrene etc.) must be disposed of in an appropriate refuse collection container. These materials must not be left within the reach of children as they are potential sources of danger.

# ASSEMBLY

**NOTE:**

Remove the plug from the power supply before carrying out adjustment, servicing or maintenance.

**SPARK DEFLECTOR: (Fig.1.)**

Locate the spark deflector (A) and the two securing screws (B). Attach it to the housing above the opening for the grinding wheel. It should be adjusted so that it is level and 1mm (approx) from the grinding wheel.

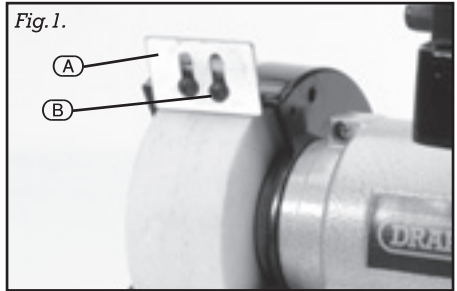

**EYE SHIELD: (Fig.2.)**

Fix the bracket (C) to the plastic screen (D) using the nuts, bolts and washers supplied. Secure the assembly to the wheel housing using the large bolt (E) and the washer as shown.

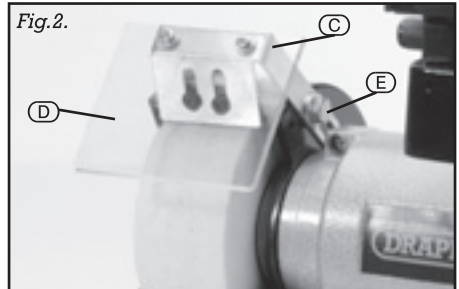

**ADJUSTABLE TOOL REST: (Fig.3 & 4.)**

Join the two parts of the tool rest (F & G) together. Insert the bolts (H) and the spring washers (I) from the inside and secure with the remaining washers and wing nuts (J).

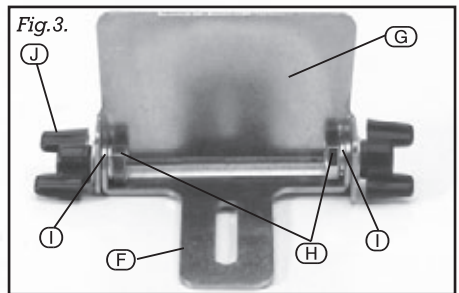

Bolt the tool rest below the grinding wheel guard opening. Ensure to butt it up against the lip which will stop it twisting. Use the bolt, washer and spring washer provided.



## ASSEMBLY

### WHETSTONE: (Fig 5 & 6.)

Slide the two tool rest brackets (K) into either side of the water tray and secure in place using the two locking knobs (L). This creates the cradle for the honing guide to sit in.

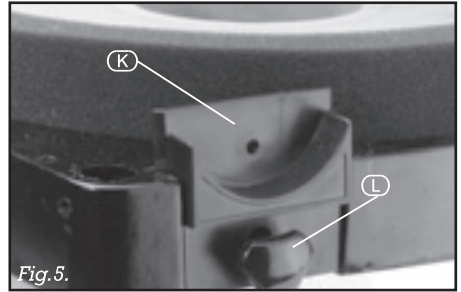

Place the honing guide (M) into the bracket and pass the bolts (N) from the back through the tool bracket and secure using the locking knobs (O). The two bolts locate into a recess to stop them turning.

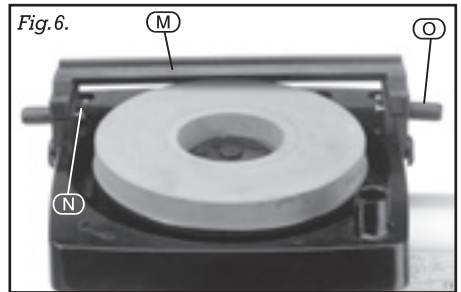

### WHETSTONE WATER RESERVOIR: (Fig.7.)

Remove the reservoir from the packaging, insert tap (P) and slide into the water tray. Position the reservoir with the outlet central over the whetstone.



### DRAINAGE PIPE: (Fig.8.)

On the underside of the water tray fit the drainage tube (Q) to the outlet (R).

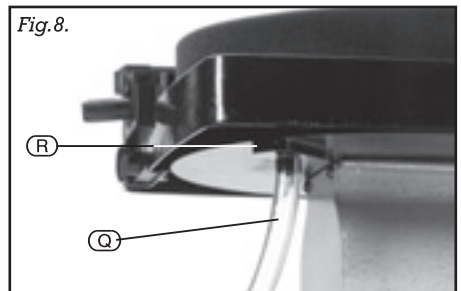

### BENCH MOUNTING:

Draper Tools recommend the wet & dry bench grinder is securely mounted to a work bench or other suitable surface. Fixings are not supplied.



# OPERATION AND USE

**NOTE:**

Remove the plug from the power supply before carrying out adjustment, servicing or maintenance.

**GRINDING:** (Fig.9.)

The grinding wheel is for dry use only. Set the tool rest at the correct angle and 1-2mm (approx.) from the wheel. Switch on the grinder at the on/off switch and let it run up to full speed to make sure nothing is obstructing the grinding wheel. If no problems are found then begin grinding. **DO NOT OPERATE WITH THE EYE SHIELD UP OR MISSING.**

**WHETSTONE HONING:** (Fig.10.)

Tilt the tool rest to the required angle for the item being sharpened. It is crucial to ensure the bottom edge of the tool rest is levels across the whetstone. Half fill the reservoir with clean water and using the tap regulate the flow of water over the whetstone. Start up the grinder and when running at full speed begin honing.

**REPLACING THE GRINDING**

**WHEEL/WHETSTONE:** (Fig.11 & 12.)

To replace the whetstone use the wheel flange holding tool (S) and unscrew clockwise (left handed thread). NOTE: It is important to check the new whetstone is free from imperfections, cracks or flaws. If suitable fit to the grinder and refit the flange making sure it is adequately tight. Turn on the grinder and let the wheel run up to full speed to ensure no problems are apparent.

To replace the grinding wheel remove the end of the wheel housing by first removing the three screws. Holding the grinding wheel to stop it slipping remove nut (T) in a clockwise direction and then flange (U). It is now possible to slide off the grinding wheel. Again it is good practice to visually check over the grinding wheel before fitting to ensure no defects are present. If usable slide the wheel on securely refit the flange and nut, tighten in an anticlockwise direction. Fit the wheel housing back and switch the grinder on to run up the wheel. Let it run for a minute to observe for any problems.

**WHEEL HOUSING ADJUSTMENT:** (Fig.13.)

The wheel housing has two positions it can be set to. To move it simply follow the instructions for replacing the dry grinding wheel up to the point where the grinding wheel is removed. Now remove the backing flange (take note which way it is fitted). Remove the screws (V) and turn the housing so the other set of holes can be used.



Fig.9.



Fig.10.



Fig.11.

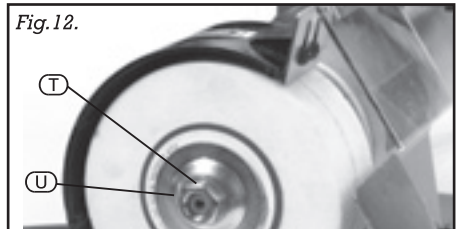

Fig.12.

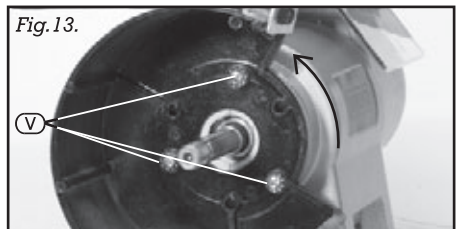

Fig.13.



## **OPTIONAL ACCESSORIES**

Part No. AG100  
Stock No.30479  
Description: Grinding wheel dresser

Part No.1180  
Stock No.10751  
Description: Drill sharpening attachment

Part No. AG205W  
Stock. No.29804  
Description: Whetstone

Part No. AG205DA  
Stock. No.38186  
Description: Grinding Wheel



**NOTES**



**THE TOOL COMPANY**

**DRAPER TOOLS LIMITED,**

Hursley Road, Chandler's Ford, Eastleigh, Hants. SO53 1YF. U.K.

Helpline: (023) 8049 4344.

Sales Desk: (023) 8049 4333.

General Enquiries: (023) 8026 6355.

Fax: (023) 8026 0784.



<http://www.draper.co.uk>

e-mail: [sales@draper.co.uk](mailto:sales@draper.co.uk)

YOUR DRAPER STOCKIST

©Published by Draper Tools Ltd.  
No part of this publication may be reproduced,  
stored in a retrieval system or transmitted in  
any form or by any means, electronic, mechanical  
photocopying, recording or otherwise without prior  
permission in writing from Draper Tools Ltd.