

25 & 50 LITRE COMPRESSORS

STOCK No.

52624
55274
33825
52625
55275
33826

PART No.

DA25/201
DA25/230
DA25/250
DA50/201
DA50/230
DA50/250

• INSTRUCTIONS •

IMPORTANT: PLEASE READ THESE INSTRUCTIONS CAREFULLY TO
ENSURE THE SAFE AND EFFECTIVE USE OF THIS TOOL.





THE TOOL COMPANY

25 & 50 LITRE COMPRESSORS

■ STOCK No.52624, 55274, 33825, 52625, 55275, 33826.

■ PART Nos. DA25/201, DA25/230, DA25/250, DA50/201, DA50/230, DA50/250.

Whilst every effort has been made to ensure accuracy of information given in this manual is correct at the time of going to print, the Draper Tools policy of continuous improvement determines the right to change specification without notice.

CONTENTS:

	Page Nos.
Specification / Guarantee.....	3
Safety Warning	4
General Safety Warning for Air Compressors and Tools	4
Power Supply	5
Know Your Air Compressor	6
Operation.....	6-7
Operation Cont'd.....	7
Maintenance.....	7
Maintenance Cont'd	8
Optional Accessories	9
Trouble Shooting Guide	10



DECLARATION OF CONFORMITY

We
Draper Tools Ltd. Hursley Road, Chandlers Ford, Eastleigh, Hampshire. SO53 1YF. England.

Declare under our sole responsibility that the product:

Stock No. 52624, 55274, 33825, 52625, 55275 & 33826.

Part No. DA25/201, DA25/230, DA25/250, DA50/201, DA50/230 & DA50/250.

Description:- Compressors 25 & 50 Litre.

To which this declaration relates is in conformity with the following directive(s)
89/392EEC, 87/404EEC & 89/336EEC.

With reference to:
EN 292-2, IEC 34-1, EN 60335-1 & EN 60204-1.



JOHN DRAPER
Managing Director

SPECIFICATION

Stock No.	52624	55274	33825	52625	55275	33826
Part No.	DA25/201	DA25/230	DA25/250	DA50/201	DA50/230	DA50/250
Air displacement	195L/min (6.9cfm)	230L/min (8.2cfm)	250L/min (8.3cfm)	195L/min (6.9cfm)	230L/min (8.2cfm)	250L/min (8.8cfm)
Free air delivered (FAD)	125L/min (4.2cfm)	160L/min (5.7cfm)	150L/min (5.3cfm)	125L/min (4.2cfm)	160L/min (5.7cfm)	150L/min (5.3cfm)
Motor	1.5HP. 230V.	2HP. 230V.	2HP. 230V.	1.5HP. 230V.	2HP. 230V.	2HP. 230V.
Speed	2800rpm	2850rpm	2800rpm	2800rpm	2850rpm	2800rpm
Maximum pressure	116 PSI (8 bar)	116 PSI (8 bar)	116PSI (8 bar)	116 PSI (8 bar)	116 PSI (8 bar)	116 PSI (8 bar)
Number of cylinders	1	1	1	1	1	1
Receiver capacity	25 litres	25 litres	25 litres	50 litres	50 litres	50 litres
Weight	26kg	25kg	27kg	36kg	39kg	37kg

The typical sound pressure level of this machine is 77db(A).
 The noise level whilst working, could exceed 85db(A) - WEAR EAR PROTECTION.

GUARANTEE

Draper compressors have been carefully tested and inspected before shipment and are guaranteed to be free from defective materials and workmanship for a period of 12 months from the date of purchase except where tools are hired out when the guarantee period is ninety days from the date of purchase.

Should the compressor develop any fault, please return the complete tool to your nearest authorized warranty repair agent or contact Draper Tools Limited, Chandler's Ford, Eastleigh, Hampshire, SO53 1YF. England. Telephone: (023) 8026 6355.

If upon inspection it is found that the fault occurring is due to defective materials or workmanship, repairs will be carried out free of charge. This guarantee does not apply to normal wear and tear, nor does it cover any damage caused by misuse, careless or unsafe handling, alterations, accident, or repairs attempted or made by any personnel other than the authorized Draper warranty repair agent.

This guarantee applies in lieu of any other guarantee expressed or implied and variations of its terms are not authorized.

Your Draper guarantee is not effective unless you can produce upon request a dated receipt or invoice to verify your proof of purchase within the 12 month period.

Please note that this guarantee is an additional benefit and does not affect your statutory rights.

Draper Tools Limited



SAFETY WARNING

WARNING:

Please read the following instructions carefully. Failure to do so could lead to serious personal injury.

IMPORTANT:

Draper Tools recommends that this compressor should not be modified or used for any application other than that for which it was designed. If you are unsure of its relative applications do not hesitate to contact us in writing and we will advise you.

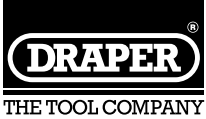

GENERAL SAFETY RULES FOR AIR COMPRESSORS AND TOOLS

1. KNOW YOUR COMPRESSOR

Before operating the compressor, read and fully understand the starting, operating and stopping sections in this manual. Read all labels affixed to the compressor. Learn its applications and limitations.

2. SERVICING AND MAINTENANCE

Do not service or maintain this compressor until you have read and understood the maintenance section of this manual.

3. CHECK DAMAGED PARTS

Before further use of this compressor a guard or other part that is damaged should be carefully checked to ensure that it will operate correctly and perform its intended function. Check for alignment of moving parts, breakage of parts and any other conditions that may effect its operation. A guard or other part that is damaged should be properly repaired or replaced.

4. DISCONNECT FROM POWER SUPPLY

Before servicing, maintaining or replacing damaged parts ALWAYS disconnect the compressor from the power supply.

5. EARTH

This compressor is equipped with an approved 3-core power cable. The green and yellow conductor in the core is the earth wire. NEVER connect the yellow and green wire to a live terminals.

6. AVOID DANGEROUS ENVIRONMENTS

Do not use the compressor in damp or wet locations or expose it to rain. Keep the work area well lit. Provide adequate surrounding work space.

*Not suitable for building sites.

7. KEEP GUARDS IN PLACE

8. AVOID ACCIDENTAL STARTING

Make sure the power supply switch is off before connecting to the power supply.

9. KEEP CHILDREN AWAY AND MAKE WORKSHOP CHILDPROOF

All visitors should be kept a safe distance from the work area. The power tools and workshop should be made childproof with padlocks, master switches or by removing starter keys.

10. NEVER LEAVE THE COMPRESSOR RUNNING UNATTENDED

Turn the power supply off. Do not leave the compressor until it comes to a complete stop.

11. DO NOT OVERLOAD THE COMPRESSOR

Before operating any air tool check that the free air delivery (FAD) from the air compressor is equal or greater than that of the air tool to be used. NOTE: the compressor should not start more than nine times in one hour.

12. AIR PRESSURE

Always check that the air supply pressure is equal to or less than the air tool manufacturers maximum operating pressure.

13. USE SAFETY GOGGLES/MASK

Wear safety goggles (which comply to a recognized standard) at all times. Normal spectacles only have impact resistant lenses, they are NOT safety glasses. Also use a face mask if a cutting operation is dusty or if spraying paint or other toxic substances.

14. USE RECOMMENDED ACCESSORIES

For a complete range of recommended accessories please refer to page 9 of this manual.

POWER SUPPLY

CONNECTING YOUR COMPRESSOR TO A POWER SUPPLY

A separate electrical socket should be used for your machine. The circuit should not be less than a 13 amp ring main which should be protected by a 30 amp fuse or miniature circuit breaker rated at 30 amps. If an extension cable is used, use only 3-core extension leads with 3-pin sockets which will accept the machine's plug. For distances up to 100 feet use 16 gauge .064 = 2.5mm wire; for distances up to 150 feet use 14 gauge .080 = 3.0mm wire. A qualified electrician should replace or repair damaged or worn cables immediately.

Before connecting the motor to the power supply, make sure the switch is in 'OFF' position and that the electric current is of the same characteristics as stamped on the motor rating plate. All cable connections should make good contact. Running on low voltage will damage the motor. See extension lead chart below.

WARNING

Single phase 230 volt machines must be connected using the relevant coding and matching the colour of the flexible cable to that of the plug.

The procedure is as follows:

1. Connect green and yellow coloured core to the plug terminal marked letter 'E' earth symbol or coloured green or green and yellow.
2. Connect brown coloured core to plug terminal marked letter 'L' (live).
3. Connect blue colour core to plug terminal marked letter 'N' (neutral).

N.B. Three phase machines must be connected by a qualified electrician.

EXTENSION LEAD CHART:

Extension lead sizes shown assure a voltage drop of not more than 5% at rated load of tool.

Ampere rating (on Name plate)	3	6	10	13
Extension cable length	Wire Size mm ²			
7.5m	0.75	0.75	1.0	1.25
15m	0.75	0.75	1.0	1.5
22.5m	0.75	0.75	1.0	1.5
30m	0.75	0.75	1.25	1.5
45m	0.75	1.25	1.5	2.5

KNOW YOUR AIR COMPRESSOR

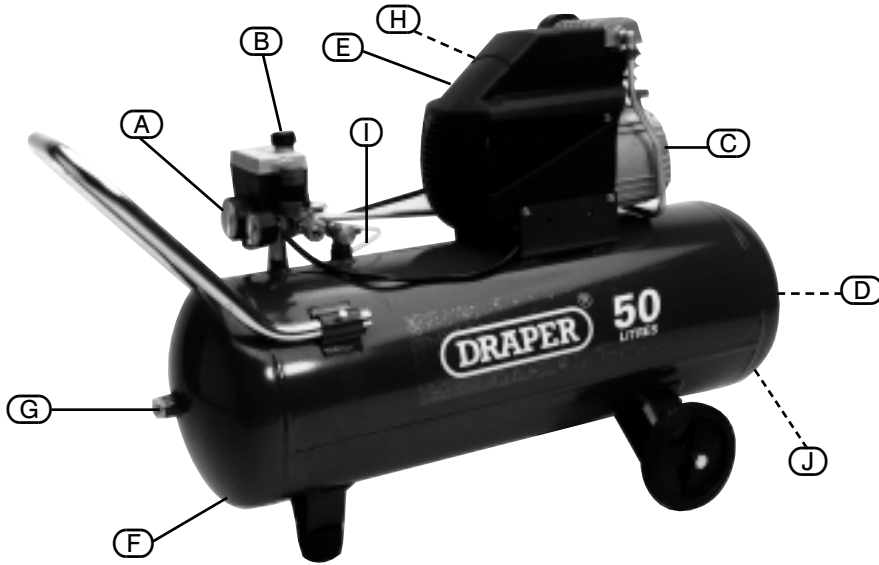

- (A) PRESSURE GAUGE - indicates air pressure in receiver.
- (B) ON/OFF SWITCH
- (C) MOTOR
- (D) RESERVOIR INSPECTION PLUG
- (E) MOTOR COWLING - covers/protects moving parts.
- (F) AIR RECEIVER - stores air.
- (G) AIR OUTLET VALVE - releases air from the reservoir.
- (H) THERMAL OVERLOAD PROTECTION RESET SWITCH
- (I) OVERLOAD SAFETY RELEASE VALVE
- (J) RESERVOIR DRAIN VALVE

OPERATION

1. **CAUTION:** You must remove the plastic transit bung from the oil sump and replace it with the dip stick (provided) before any initial use of the compressor to avoid any long term problems. Connect the compressor to the power supply. Always turn the machine on and off by means of the appropriate switch (A) Fig.1. located on top of the pressure switch box.

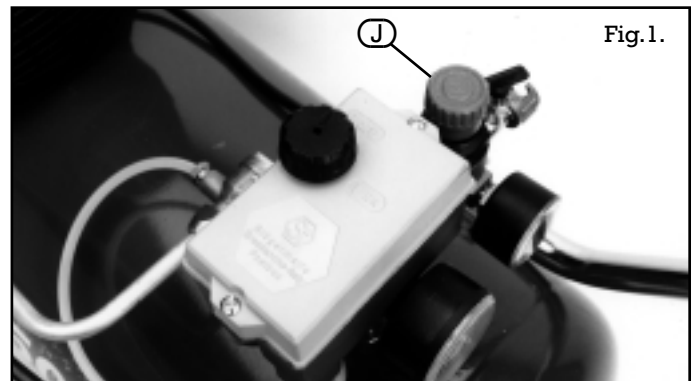

Fig.1.

2. Check that the reservoir drain valve is closed (B) Fig.2.

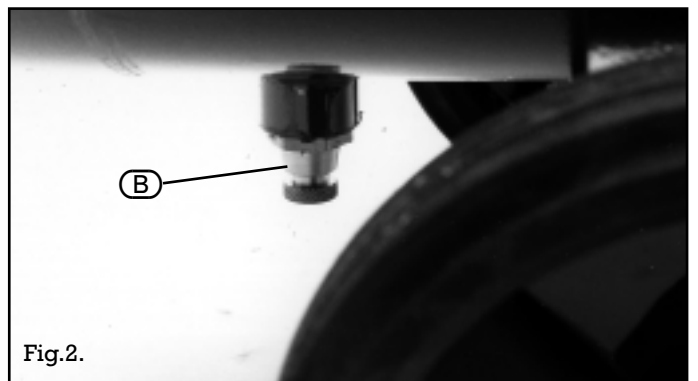

Fig.2.

3. These compressors are controlled by a pressure switch assembly (C) which automatically cuts off the power supply to the motor when the maximum operating pressure is reached and restarts the compressor when the compressor drops below the pre-set minimum.

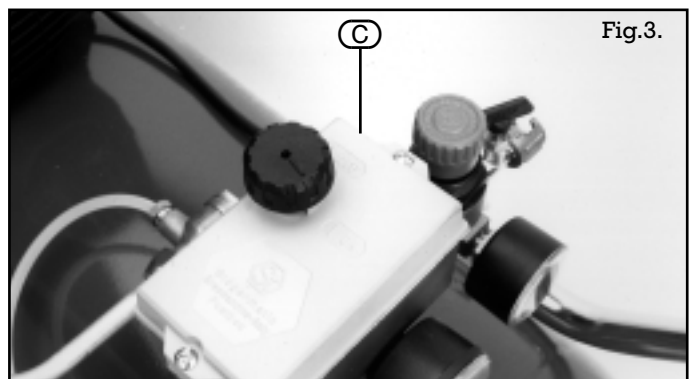
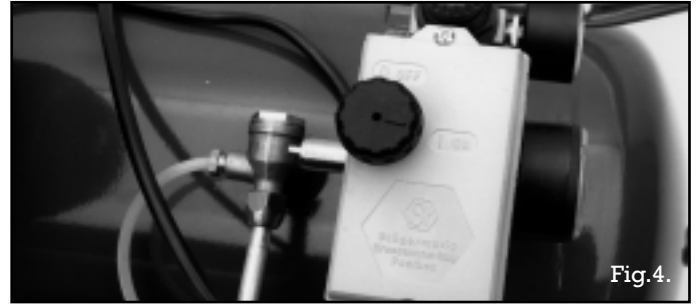

Fig.3.

OPERATION Cont'd

4. To start the compressor turn the switch to the ON position as shown in Fig.4.

The pressure switch is pre-set at the factory and the compressor is also fitted with an overload safety relief valve in the event of the pressure switch not functioning correctly.



5. To stop the compressor turn the pressure switch to the OFF position. Do not switch off at the power supply before switching off at the machine. See Fig.5.

The amount of air pressure inside the receiver is indicated by the gauge (D) Fig.5.

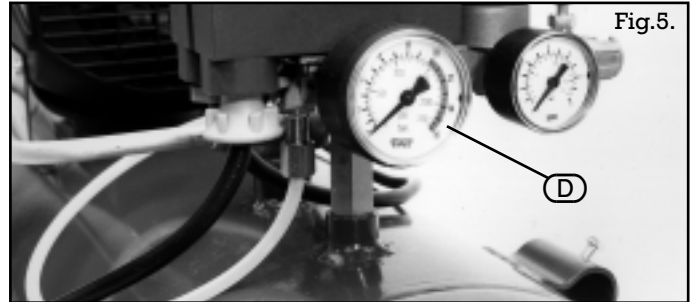

MAINTENANCE

IMPORTANT:

Before performing any maintenance operations, disconnect the compressor from the power supply and release all the air from the receiver, until the pressure gauge reads zero.

EVERY DAY:

- A. Check the oil level and top up if required with Shell Corena P68 Monograde oil or equivalent.
- B. Drain the condensate from the receiver. The drain plug (E) Fig. 6. is situated on the underside of the receiver tank.

EVERY MONTH:

- A. Clean the air suction filter using compressed air. Replace the filter every 500 hours of use.
NOTE:- The position of the filter will vary on each model, refer to the parts listing & drawing of the model concerned.
- B. Check the tension of the drive belt and adjust if necessary.

EVERY 1000 HOURS:

- A. Replace the oil. Remove the drain plug (F) Fig.7. and drain the oil into a suitable container. Refit the drain plug and refill the crank case with new oil to the correct level.
- B. Clean all the external surfaces of the pump unit and motor. Ensure that neither the motor fan cowling (G) or head cooling fins (H) are blocked or obstructed in any way. See Fig.8.

EVERY 2000 HOURS:

Check the condition of the valves and replace

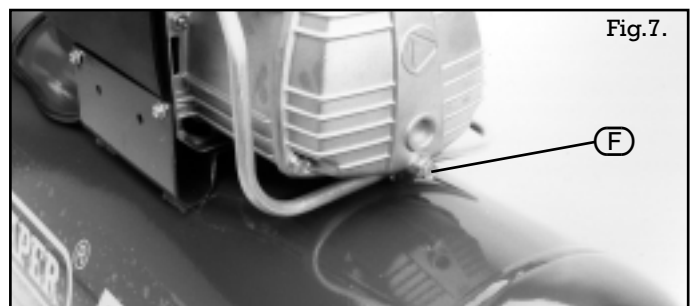
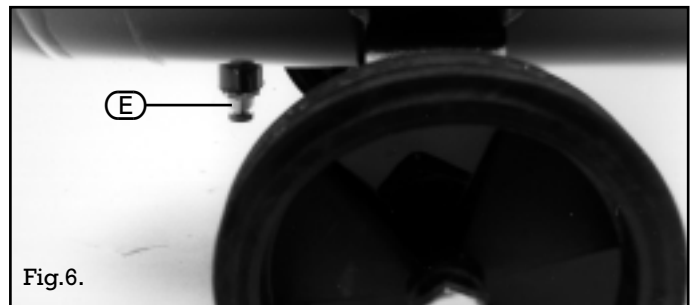

PRESSURE SWITCH SETTINGS:

The delivery pressure setting can drift over a period of time and will require periodic adjustment. Ensure that the pressure switch settings are correctly adjusted and maintained at the correct level. This will help prevent faults occurring which can result in reduced performance and possible failure.

PRESSURE SWITCH ADJUSTMENTS:

To adjust the pressure level at which the cut-out functions, remove the switch cover and turn the pressure regulating screw clockwise to increase the level and anticlockwise to decrease the level. See Fig.9.

To adjust the cut-in pressure turn the cut-in pressure regulating screw clockwise to increase the level and anticlockwise to decrease the level.

WARNING:

DO NOT ADJUST THE CUT-IN PRESSURE ABOVE THE MAXIMUM PRESSURE AS PER THE MACHINE SPECIFICATION.

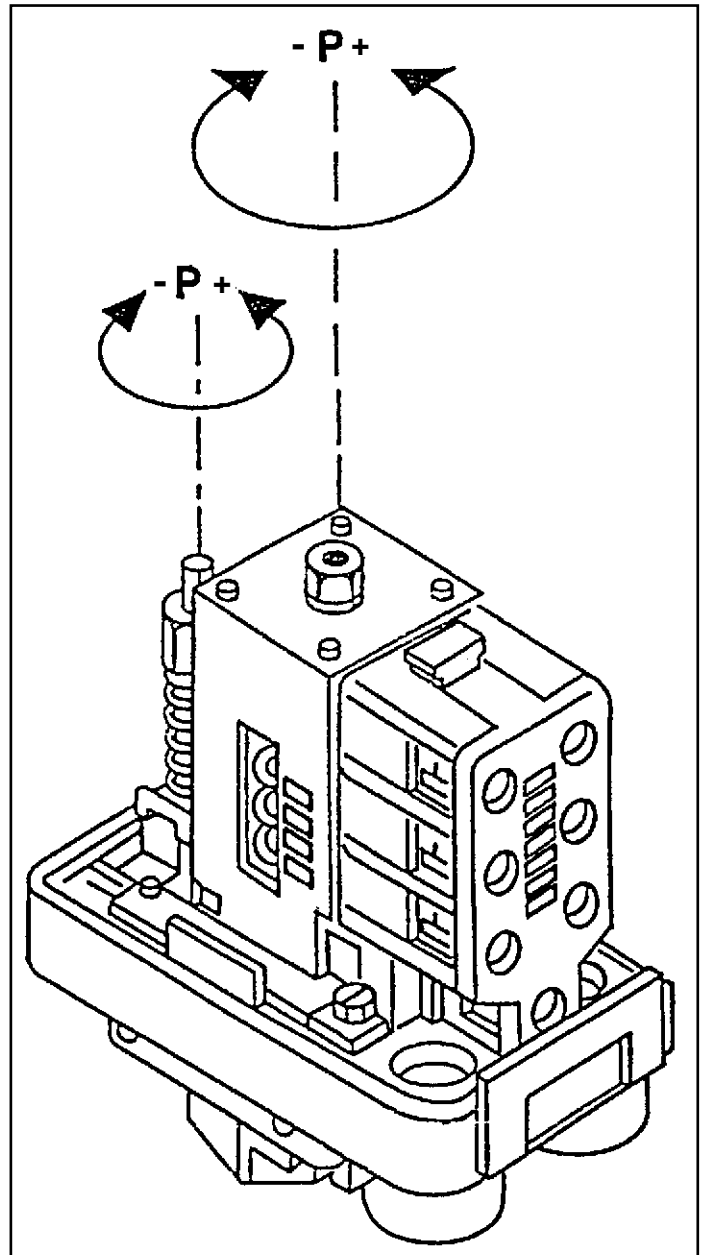

OPTIONAL ACCESSORIES

The following accessories are available from your local Draper air tool stockist.

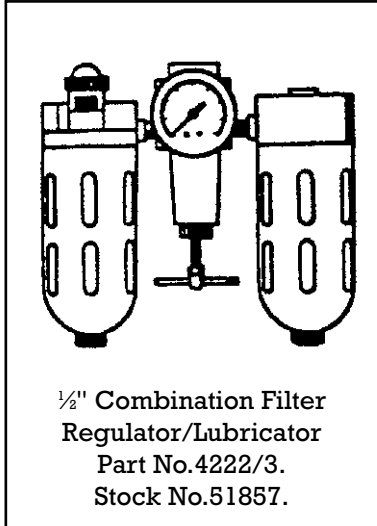

**1/2" Combination Filter
Regulator/Lubricator**
Part No.4222/3.
Stock No.51857.

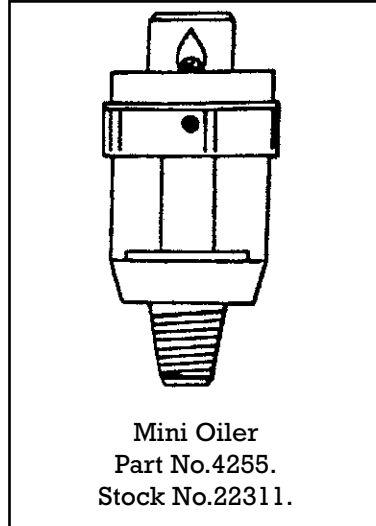

Mini Oiler
Part No.4255.
Stock No.22311.

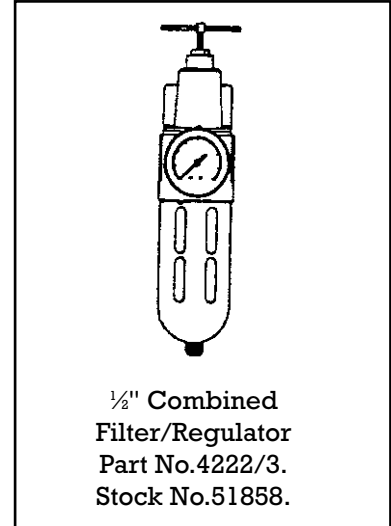

**1/2" Combined
Filter/Regulator**
Part No.4222/3.
Stock No.51858.

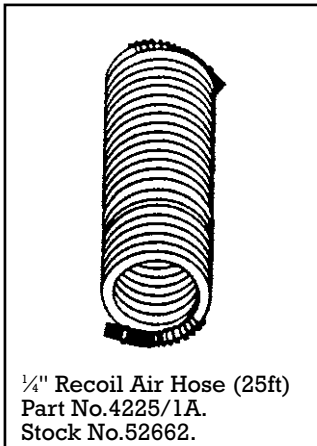

1/4" Recoil Air Hose (25ft)
Part No.4225/1A.
Stock No.52662.

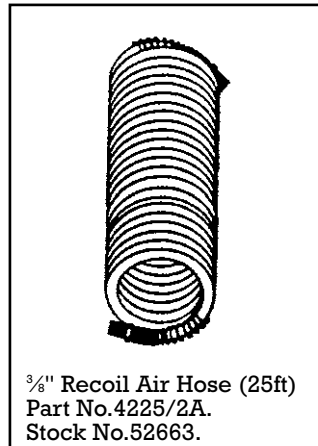

3/8" Recoil Air Hose (25ft)
Part No.4225/2A.
Stock No.52663.

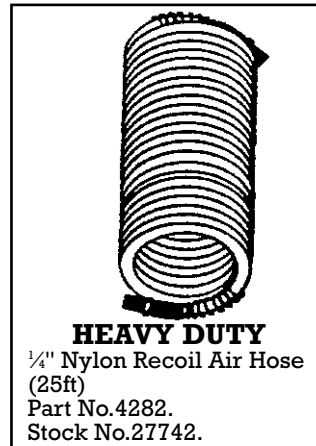

HEAVY DUTY
1/4" Nylon Recoil Air Hose
(25ft)
Part No.4282.
Stock No.27742.

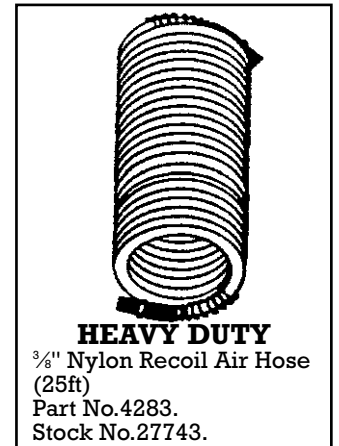

HEAVY DUTY
3/8" Nylon Recoil Air Hose
(25ft)
Part No.4283.
Stock No.27743.

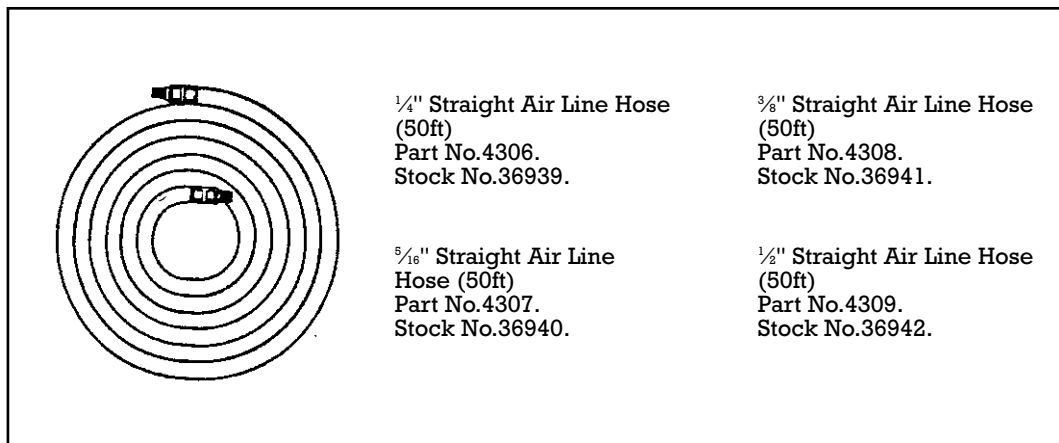

1/4" Straight Air Line Hose
(50ft)
Part No.4306.
Stock No.36939.

3/8" Straight Air Line Hose
(50ft)
Part No.4308.
Stock No.36941.

**5/16" Straight Air Line
Hose (50ft)**
Part No.4307.
Stock No.36940.

1/2" Straight Air Line Hose
(50ft)
Part No.4309.
Stock No.36942.

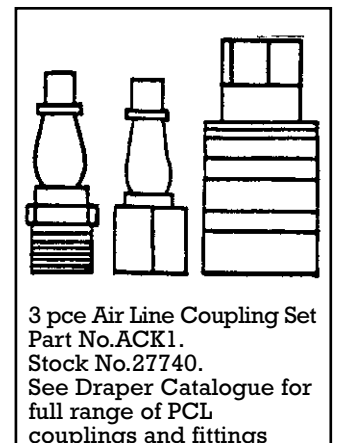

3 pce Air Line Coupling Set
Part No.ACK1.
Stock No.27740.
See Draper Catalogue for
full range of PCL
couplings and fittings

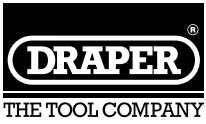

TROUBLE SHOOTING GUIDE

SYMPTOMS	POSSIBLE CAUSES
Thermal overload protection trips.	Oil level low. Wrong direction of rotation. Pressure switch failure/motor overload.
High oil consumption.	Air filter clogged. Wrong type of oil. Broken piston rings.
Oil pumping.	Air filter clogged. Wrong type of oil Oil level too high. Piston scratched, worn or scored.
Noisy operation (knocking).	Loose drive pulley, coupling or excessive wear in the motorshaft. Loose fly wheel, drive belt loose. Low oil level.
Milky oil in crankcase (water in oil).	High humidity. Change oil more frequently.
Oil in compressor air supply.	Air filter clogged, oil level too high.
Low air output.	Kinked hose, leaking connections. Air filter clogged. Piston rings broken or incorrectly seated in. Cylinder or piston scratched, worn or scored. Drive belt loose.
Excessive belt drive wear.	Belt loose - slipping, belt too tight. Pulley and flywheel misaligned.
High moisture contents in air output.	Caused by high humidity. Drain any excess moisture from receiver. Move to an area less humid.
Excessive starting and stopping.	High moisture content in receiver. Air leaks in piping/connections.
Compressor will not start.	Power cable faulty, fuse blown, circuit breaker open. Motor thermal overload protection tripped or faulty. Pressure switch faulty. Check if the receiver pressure is higher than the pressure switch cut-out pressure (motor will re-start when the receiver pressure drops below the cut-in pressure).
Air blowing from inlet.	Broken inlet valves.
Compressor runs continuously.	Defective pressure switch.
Compressor runs but does not produce air.	Check all valves are closed. Inspect all gasket in case one is broken check drive belt is not slipping or broken.
General air leaks.	These result from poor seals on some fittings.

IMPORTANT: PLEASE NOTE ALL REPAIRS/ADJUSTMENTS SHOULD BE CARRIED OUT BY A QUALIFIED PERSON.

**POWER DIVISION HELP LINE:
(023) 8049 4344**

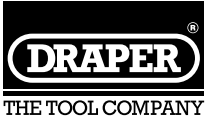

NOTES

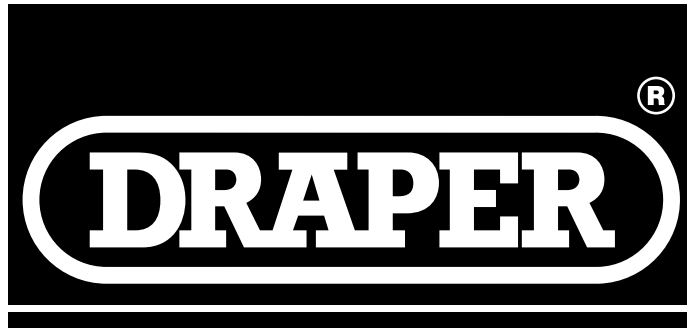

THE TOOL COMPANY

DRAPER TOOLS LTD.

Hursley Road, Chandler's Ford,
Eastleigh, Hants. SO53 1YF. England.

Tel: (023) 8026 6355.

Fax: (023) 8026 0784.



www.draper.co.uk

e-mail: sales@draper.co.uk

YOUR DRAPER STOCKIST

©Published by Draper Tools Ltd.
No part of this publication may be reproduced,
stored in a retrieval system or transmitted in any
form or by any means, electronic, mechanical
photocopying, recording or otherwise without
prior permission in writing from Draper Tools Ltd.