

DRAPER
Expert

XP20
MULTI-TOOL BATTERY SYSTEM

GB

20V BRUSHLESS 115mm

3 Year
WARRANTY

ANGLE GRINDER

55953



CE

These instructions accompanying the product are the original instructions. This document is part of the product, keep it for the life of the product passing it on to any subsequent holder of the product. Read all these instructions before assembling, operating or maintaining this product.

This manual has been compiled by Draper Tools describing the purpose for which the product has been designed, and contains all the necessary information to ensure its correct and safe use. By following all the general safety instructions contained in this manual, it will ensure both product and operator safety, together with longer life of the product itself.

All photographs and drawings in this manual are supplied by Draper Tools to help illustrate the operation of the product.

Whilst every effort has been made to ensure the accuracy of information contained in this manual, the Draper Tools policy of continuous improvement determines the right to make modifications without prior warning.

1. TITLE PAGE

1.1 INTRODUCTION:

USER MANUAL FOR: 20V Brushless 115mm Angle Grinder

Stock No: 55953

Part No: XP20AG115

1.2 REVISIONS:

Date first published January 2019.

As our user manuals are continually updated, users should make sure that they use the very latest version.

Downloads are available from: <http://drapertools.com/manuals>

Draper Tools Limited
Hursley Road
Chandler's Ford
Eastleigh
Hampshire
SO53 1YF
UK

Website: drapertools.com

Product help line: +44 (0) 23 8049 4344

General Fax: +44 (0) 23 8026 0784

1.3 UNDERSTANDING THIS MANUALS SAFETY CONTENT:

WARNING! – Information that draws attention to the risk of injury or death.

CAUTION! – Information that draws attention to the risk of damage to the product or surroundings.

1.4 COPYRIGHT © NOTICE:

Copyright © Draper Tools Limited.

Permission is granted to reproduce this publication for personal and educational use only. Commercial copying, redistribution, hiring or lending is prohibited.

No part of this publication may be stored in a retrieval system or transmitted in any other form or means without written permission from Draper Tools Limited.

In all cases this copyright notice must remain intact.

2. CONTENTS

1. TITLE PAGE	
1.1 INTRODUCTION.....	2
1.2 REVISION HISTORY	2
1.3 UNDERSTANDING THIS MANUAL	2
1.4 COPYRIGHT NOTICE	2
2. CONTENTS	
2.1 CONTENTS.....	3
3. WARRANTY	
3.1 WARRANTY.....	4
4. INTRODUCTION	
4.1 SCOPE.....	5
4.2 SPECIFICATION	5
4.3 HANDLING & STORAGE.....	5
5. HEALTH AND SAFETY INFORMATION	
5.1 GENERAL SAFETY INSTRUCTIONS FOR POWER TOOL USE	6-7
5.2 SPECIFIC SAFETY INSTRUCTIONS FOR GRINDER USE	7-8
5.3 SAFETY RECOMMENDATIONS FOR THE CORRECT USE OF ABRASIVE PRODUCTS	8-9
5.4 SAFETY RECOMMENDATIONS FOR THE CORRECT USE OF SUPERABRASIVES.....	9-10
5.5 RESIDUAL RISK	10
5.6 SAFETY INSTRUCTIONS FOR MAINS POWERED BATTERY PACKS & CHARGERS.....	10-11
5.7 CONNECTION TO THE POWER SUPPLY (CHARGER)	12
6. TECHNICAL DESCRIPTION	
6.1 IDENTIFICATION	13
7. UNPACKING AND CHECKING	
7.1 PACKAGING	14
7.2 XP20 MULTI-TOOL INTERCHANGEABLE BATTERY SYSTEM.....	14
7.3 WHAT'S IN THE BOX.....	14
8. PREPARING THE ANGLE GRINDER	
8.1 BATTERY PACK CHARGING	15-16
8.2 BATTERY PACK PROTECTION FEATURES	16
8.3 BATTERY PACK CHARGE STATUS.....	16
8.4 BATTERY LIFE EFFICIENCY AND CHARGING ADVICE	16
9. PREPARING THE ANGLE GRINDER	
9.1 FITTING AUXILIARY HANDLES	17
9.2 FITTING THE GUARD	17
9.3 FITTING/REPLACING ACCESSORIES (SOLD SEPARATELY).....	18
9.4 FITTING GRINDING DISCS	19
10. BASIC ANGLE GRINDER OPERATIONS	
10.1 ON/OFF SWITCH.....	20
10.2 GRINDING	20
10.3 CUTTING	20
11. MAINTENANCE AND TROUBLESHOOTING	
11.1 MAINTENANCE	21
11.2 TROUBLESHOOTING	21
12. OPTIONAL ACCESSORIES	
12.1 OPTIONAL ACCESSORIES.....	22
13. DISPOSAL	
13.1 DISPOSAL.....	22
13.2 BATTERY PACK DISPOSAL INFORMATION.....	22
14. EXPLANATION OF SYMBOLS	
14.1 EXPLANATION OF SYMBOLS	23
DECLARATION OF CONFORMITY	ENCLOSED

3. WARRANTY

3.1 WARRANTY

Draper tools have been carefully tested and inspected before shipment and are guaranteed to be free from defective materials and workmanship.

Should the tool develop a fault, please return the complete tool to your nearest distributor or contact:

Draper Tools Limited, Chandler's Ford, Eastleigh, Hampshire, SO53 1YF. England.

Telephone Sales Desk: (023) 8049 4333 or:

Product Helpline (023) 8049 4344.

A proof of purchase **must** be provided.

If upon inspection it is found that the fault occurring is due to defective materials or workmanship, repairs will be carried out free of charge. This warranty period covering labour is 12 months from the date of purchase except where tools are hired out when the warranty period is 90 days from the date of purchase. The warranty is extended to 24 months from the date of purchase for parts only. This warranty does not apply to any consumable parts, any type of battery or normal wear and tear, nor does it cover any damage caused by misuse, careless or unsafe handling, alterations, accidents, or repairs attempted or made by any personnel other than the authorised Draper warranty repair agent.

Draper Tools Limited takes pride in the quality of its products and the services offered to our valued customers. As a result we offer a free, 3 year extended warranty for this product.

REGISTER WITHIN 30 DAYS TO CLAIM YOUR

FREE



*To register your warranty, visit: **drapertools.com/warranty-registration**
or call our Customer Helpline on: **(023) 8049 4344**

By registering your product you'll automatically become a Draper Club Member where you will have the option to receive news of our new products, offers, deals, competitions and more!

If you are unable to register online, please call our Customer Helpline on the number shown above. Full registration must be completed within 30 days from receipt of purchase. The 3 year extended warranty only applies to permanent UK residents, to the original product purchased from an authorised Draper Tools stockist for use in their appropriate profession/trade. This warranty is not valid to purchasers reselling or hiring the product. This warranty is not transferable and is only available to the original product purchaser who has completed their registration and is a Draper Club Member. The 3 year extended warranty period starts from the date of purchase and is not extended following an inspection, repair or replacement.

Note: If the tool is found not to be within the terms of warranty, repairs and carriage charges will be quoted and made accordingly.

This warranty applies in lieu of any other warranty expressed or implied and variations of its terms are not authorised.

Your Draper warranty is not effective unless you can produce upon request a dated receipt or invoice to verify your proof of purchase within the warranty period.

Please note that this warranty is an additional benefit and does not affect your statutory rights.

Draper Tools Limited.

For full terms and conditions visit: drapertools.com/corporate-policies

4. INTRODUCTION

4.1 SCOPE

This hand held power tool uses abrasive discs to grind/cut metals or masonry.

It is intended for trade use and has the quality and features to meet and exceed the expectations of the most demanding user.

Any application other than that it was designed for is considered misuse.

4.2 SPECIFICATION

Stock No.	55953
Part No.	XP20AG115
Rated voltage	20V
Revolutions per minute (no load):	8,000r/min
Disc Diameter:	115mm
Spindle thread:	M14
Bore	22.2mm
Sound pressure level (LpA)*:	87.1dB(A)
Sound power level (LWA)**:	98.1dB(A)
Uncertainty (K):	3dB(A)
Vibration level Main handle:	8.363m/s ² , K=1.5m/s ²
Vibration level Extra handle:	9.412m/s ² , K=1.5m/s ²
Weight (machine only):	1.5kg

* *Continuous A-Weighted Sound Pressure Level at the workstation in accordance to and declared according to EN60745.*

** *The typical A-weighted noise level determined according to EN60745.*

4.3 HANDLING & STORAGE

- Care must be taken when handling this product.
 - Dropping this power tool could have an effect on its accuracy and could also result in personal injury. This product is not a toy and must be respected.
- Environmental conditions can have a detrimental effect on this product if neglected.
 - Exposure to damp air can gradually corrode components.
 - If the product is unprotected from dust and debris, components will become clogged.
 - If not cleaned and maintained correctly or regularly, the machine will not perform at its best.

5. HEALTH AND SAFETY INFORMATION

5.1 GENERAL SAFETY INSTRUCTIONS FOR POWER TOOL USE

When using any type of power tool there are steps that should be taken to make sure that you, as the user, remain safe.

Common sense and a respect for the tool will help reduce the risk of injury.

Read the instruction manual fully. Do not attempt any operation until you have read and understood this manual.

Most important you must know how to safely start and stop this machine, especially in an emergency.

Keep the work area tidy and clean. Attempting to clear clutter from around the machine during use will reduce your concentration. Mess on the floor creates a trip hazard. Any liquid spilled on the floor could result in you slipping.

Find a suitable location. If the machine is bench mounted, the location should provide good natural light or artificial lighting as a replacement. Avoid damp and dust locations as it will have a negative effect on the machine's performance. If the machine is portable do not expose the tool to rain. In all cases do not operate power tools near any flammable materials.

Keep bystanders away. Children, onlookers and passers by must be restricted from entering the work area for their own protection. The barrier must extend a suitable distance from the tool user.

Unplug and house all power tools that are not in use. A power tool should never be left unattended while connected to the power supply. They must be housed in a suitable location, away locked up and from children. This includes battery chargers.

Do not overload or misuse the tool. All tools are designed for a purpose and are limited to what they are capable of doing. Do not attempt to use a power tool (or adapt it in any way) for an application it is not designed for. Select a tool appropriate for the size of the job. Overloading a tool will result in tool failure and user injury. This covers the use of accessories.

Dress properly. Loose clothing, long hair and jewellery are all dangerous because they can become entangled in moving machinery. This can also result in parts of body being pulled into the machine. Clothing should be close fitted, with any long hair tied back and jewellery and neck ties removed. Footwear must be fully enclosed and have a non-slip sole.

Wear personal protective equipment (PPE). Dust, noise, vibration and swarf can all be dangerous if not suitably protected against. If the work involving the power tool creates dust or fumes wear a dust mask. Vibration to the hand, caused by operating some tools for longer periods must be protected against. Wear vibration reducing gloves and allow long breaks between uses. Protect against dust and swarf by wearing approved safety goggles or a face shield. These are some of the more common hazards and preventions, however, always find out what hazards are associated with the machine/work process and wear the most suitable protective equipment available.

Do not breathe contaminated air. If the work creates dust or fumes connect the machine (if possible) to an extraction system either locally or remotely. Working outdoors can also help if possible.

Move the machine as instructed. If the machine is hand held, do not carry it by the power supply cable. If the product is heavy, employ a second or third person to help move it safely or use a mechanical device. Always refer to the instructions for the correct method.

Do not overreach. Extending your body too far can result in a loss of balance and you falling. This could be from a height or onto a machine and will result in injury.

Maintain your tools correctly. A well maintained tool will do the job safely. Replace any damaged or missing parts immediately with original parts from the manufacturer. As applicable, keep blades sharp, moving parts clean, oiled or greased, handles clean, and emergency devices working.

5. HEALTH AND SAFETY INFORMATION

Wait for the machine to stop. Unless the machine is fitted with a safety brake, some parts may continue to move due to momentum. Wait for all parts to stop, then unplug it from the power supply before making any adjustments, carrying out maintenance operations or just finishing using the tool.

Remove and check setting tools. Some machinery requires the use of additional tools or keys to set, load or adjust the power tool. Before starting the power tool always check to make certain they have been removed and are safely away from the machine.

Prevent unintentional starting. Before plugging any machine in to the power supply, make sure the switch is in the OFF position. If the machine is portable, do not hold the machine near the switch and take care when putting the machine down, that nothing can operate the switch.

Carefully select an extension lead. Some machines are not suitable for use with extension leads. If the tool is designed for use outdoors, use an extension lead also suitable for that environment. When using an extended lead, select one capable of handling the current (amps) drawn by the machine in use. Fully extend the lead regardless of the distance between the power supply and the tool. Excess current (amps) and a coiled extension lead will both cause the cable to heat up and can result in fire.

Concentrate and stay alert. Distractions are likely to cause an accident. Never operate a power tool if you are under the influence of drugs (prescription or otherwise), including alcohol or if you are feeling tired. Being disorientated will result in an accident.

Have this tool repaired by a qualified person. This tool is designed to conform to the relevant international and local standards and as such should be maintained and repaired by someone qualified, using only original parts supplied by the manufacturer. This will ensure the tool remains safe to use.

5.2 SPECIFIC SAFETY INSTRUCTIONS FOR GRINDER USE

Have this tool repaired by a qualified person. This tool is designed to conform to the relevant international and local standards. As such, it should be maintained and repaired by someone qualified, using only original parts supplied by the manufacturer – This will ensure the tool remains safe to use.

- Check that speed marked on the wheel is equal to or greater than the rated speed of the grinder.
- Ensure that the wheel dimensions are compatible with the grinder.
- Abrasive wheels must be stored and handled with care in accordance with manufacturer's instructions.
- Inspect the grinding wheel before use. Do not use chipped, cracked or otherwise defective products.
- Ensure that mounted wheels and points are fitted in accordance with the manufacturer's instructions.
- Ensure that the abrasive product is correctly mounted and tightened before use.
 - Run the tool at no-load for 30 seconds in a safe position.
 - Stop immediately if there is considerable vibration or if other defects are detected. If this condition occurs, check the machine to determine the cause.
- Never use the angle grinder without the safety guard.
- Do not use separate reducing bushings or adapters to adapt large hole abrasive wheels.
- Check that the work piece is properly supported.
- Do not use cutting wheel for side grinding.
- Ensure that sparks resulting from use do not create a hazard e.g. do not hit persons, to ignite flammable substances.
- Always use eye and ear protection.
- Personal protective equipment such as dust mask, gloves, helmet and apron should be worn.
- The wheel continues to rotate after the tool is switched off.

5. HEALTH AND SAFETY INFORMATION

Warning! Prior to mounting an abrasive wheel ensure the expiry date has not exceeded rendering it potentially hazardous.

Secure work. Use clamps or a vice to hold the work. It is safer than using your hands and it frees both hands to operate the tool.

Stay alert. Watch what you are doing. Use common sense. Do not operate tool when you are tired.

Wear proper clothing. Do not wear loose clothing, neckties or jewellery (ring, wristwatches etc.) to catch in moving parts. Non-slip footwear is recommended. Wear protective covering to contain long hair. Roll long sleeves above the elbow.

Use safety goggles (Head protection). Wear goggles approved to the relevant standards at all times. Normal spectacles only have impact resistant lenses, they are NOT safety glasses. Also, use face or dust mask if application is dusty and ear protectors during all operations.

Sound levels. Some types of machines may have high sound levels when working. In such cases ear protection must be worn.

Vibration levels. Hand held power tools produce different vibration levels. You should always refer to the specifications and the relevant Health and Safety guidelines.

Dust extraction. If your tool is fitted with a dust extraction facility, always ensure that it is connected and being used with a dust extractor. Vacuum cleaners can be used if suitable for the material being extracted.

Check damaged parts. Before use, any blade guard or other part that is damaged should be carefully checked to determine that it will operate properly and perform its intended function. Check for alignment of moving parts, free running of moving parts, breakage of parts, mounting and any other conditions that may affect its operation. A guard or other part that is damaged should be properly repaired or replaced by an authorised service centre unless otherwise indicated in this instruction manual. Have defective switches replaced by an authorised service centre. Do not use the tool if the switch does not turn it on and off.

Have your tool repaired by a qualified person. Use of this electric tool is in accordance with the relevant safety requirements. Repairs should only be carried out by qualified persons using original spare parts, otherwise this may result in considerable danger to the user.

5.3 SAFETY RECOMMENDATIONS FOR THE CORRECT USE OF ABRASIVE PRODUCTS

General. Bonded abrasive products are breakable and shall therefore be handled with utmost care. The use of damaged or improperly mounted or used abrasive products is dangerous and can cause serious injuries.

Delivery, handling and storage. Abrasive products must be handled and transported with care. Abrasive products must be stored in such a manner that they are not subjected to mechanical damaged and harmful environmental influences.

Selection of the abrasive product. Information on the label or the abrasive product stating restrictions of use, safety indications or any other instructions must be followed. In case of doubt concerning the selection of abrasive products, the user shall request information from the manufacturer or supplier.

Visual inspection and ring test. Abrasive products must be subjected to a visual inspection as received before mounting. In addition, a ring test shall be executed for vitrified wheels with $D > 80\text{mm}$. Damaged abrasive products shall be destroyed.

Mounting before starting and information for grinding. The mounting of abrasive products shall be carried out according to the instructions provided by both the wheel and the machine manufacturer. Mounting of abrasive products must be carried out by a qualified trained person. After initial mounting, the wheel must be test run for a reasonable time – the specified maximum operating speed of the wheel shall not be exceeded.

5. HEALTH AND SAFETY INFORMATION

Further information. The following instructions must be observed, supplementary to the information contained in the instruction for use of the grinding machine:

- Observance of the user's information from the grinding machine manufacturer.
- Safety devices shall be mounting to the machine and shall be secured.
- No grinding operations without protection by safety devices.
- Use of personal protective equipment according to the type of machine and type of application, e.g. eye and face protection, ear protection, respiratory protective devices, protective footwear, protective gloves and other protective clothing.
- Only grinding operations for which the abrasive product is suitable shall be carried out (taking into account restrictions of use, safety indications or other information).
- Jamming of the hand-held grinding machine shall be prevented. In the case of cutting-off with hand-held grinding machines, the abrasive product shall be placed in the cutting gap in a straight position.
- Before placing the hand-held grinding machine on the workbench or on the floor it shall be turned off and it shall be ensured that the abrasive product has stopped.

5.4 SAFETY RECOMMENDATIONS FOR THE CORRECT USE OF SUPERABRASIVES

General. Superabrasives are breakable and shall therefore be handled with utmost care! The use of damaged or improperly mounted or used superabrasives is dangerous and can cause serious injuries.

Delivery, handling and storage. Superabrasives shall be handled and transported with care. Superabrasives shall be stored in such a manner that they are not subjected to mechanical damages and harmful environmental influences.

Selection of superabrasives. Information on the label or the superabrasive as well as restrictions of use, safety indications or any other instruction shall be followed. In case of doubt concerning the selection of superabrasives, the user shall request information from the manufacturer or supplier.

Visual inspection and ring test. Superabrasives shall be subjected to a visual inspection as received before mounting. In a addition, a ring test shall be executed for superabrasives with vitrified core and abrasive section and $D > 80\text{mm}$. Damaged superabrasives shall not be used.

Mounting, before starting and information for grinding. The mounting of superabrasive shall be carried out according to the instructions provided by both, the superabrasive and the machine manufacturer. Special attention shall be drawn to the fact that mounting of superabrasives is to be carried out by a qualified trained person. Each time after mounting, the superabrasive shall be test run for a reasonable time - the specified maximum operating speed of the superabrasive shall not be exceeded.

Further information. The following instructions shall be observed, supplementary to the information of the grinding machine:

- Observance of the user's information of grinding machine manufacturer.
- Before starting, safety devices shall be mounted to the machine.
- No grinding operations without protection by safety devices.
- Use of personal protective equipment according to the type of machine and type of application, e.g. eye and face protection, ear protection, respiratory protection devices, protective footwear, protective gloves and other protective clothing.
- Only grinding operations for which the superabrasive is suitable shall be carried out (taking into account restrictions of use, safety indications or other information).
- In the case of cutting-off with hand-held grinding machines, the superabrasive shall be placed in the cutting gap in a straight position. Jamming of the hand-held grinding machine shall be prevented.

5. HEALTH AND SAFETY INFORMATION

- Before placing the hand-held grinding machine on the workbench or on the floor it shall be turned off and it shall be ensured that the abrasive product has stopped.

5.5 RESIDUAL RISK

Important note: Although the safety instructions and operating manuals for our tools contain extensive instructions for safe working with power tools, every power tool involves a certain residual risk which can not be completely excluded by safety mechanisms. Power tools must therefore always be operated with caution!

5.6 SAFETY INSTRUCTIONS FOR MAINS POWERED BATTERY PACKS & CHARGERS

Note: This power product is supplied “bare”, without battery pack or charger. Draper Expert XP20 battery packs and chargers are available separately through all local Draper Tools stockists.

Chargers

- The charger is for indoor use only.
- Prior to plugging the charger in to the supply, check that the plug and the cable are in good repair. If either are damaged, have the defective item replaced immediately by a suitably qualified person. If the casing of the battery charger is damaged, it is good policy to have the charger checked over by a suitably qualified person.
- Only use a correctly rated mains outlet to provide power, do not plug into site generators, attach to engine generators or D.C. sources. Do not use a mains socket outlet that is not switched.
- Use the correct Draper charger in conjunction with it’s corresponding battery pack (consult the Draper website for more information or to find your local stockist).
- Do not charge any other batteries with Draper chargers. Any other application is considered misuse.
- Do not attempt to charge battery packs that are too hot (over 30°C) or too cold (under 5°C), if these conditions apply set the battery pack aside to “normalise” before proceeding with the charging operation.
- Set up the charger and cable in a safe place where it won’t be knocked, tripped over, stepped on, etc. and where it is well ventilated. Make sure the ventilation slots in the charger case are not obstructed, plug the charger into the socket outlet.
- Inspect the battery pack for damage, if it is undamaged, plug it into the charger, ensuring the correct orientation. (Most chargers and batteries have ‘keys’ etc, to make sure the battery pack is not inserted incorrectly, if you are having to ‘force’ the battery pack into the charger, the chances are you have it the wrong way round, check and try again.)
- Switch the charger on and check that the correct indicators illuminate, allow the battery pack to charge (see the specific instructions for your charger). Once charging is complete, switch the charger off, remove the battery pack and store, repeat the procedure if you have more than one battery pack to charge.

Caution: When the battery charger has been continuously used, the battery charger will be hot.

5. HEALTH AND SAFETY INFORMATION

Once the charging has been completed, give 15 minutes rest until the next charge.

- After charging is complete, unplug the charger from the socket outlet by pulling on the plug. Do not pull on the cable. Store the charger in a dry secure place.
- If, when the charger was switched on, the correct indications did not occur, leave for two or three minutes to allow the charger to stabilise, if the correct indications occur, allow the charging cycle to proceed as normal. If no indication appears at all, switch off, remove the battery pack, unplug the charger, check that the charger contacts and the battery contacts are clean and repeat the process. If there is still no indication, switch off, remove the battery pack, unplug the charger and check the fuse. If the fuse is blown, replace and repeat the process. If the fuse blows again, or if the fuse was intact, attempt no further action. Refer the charger to a suitably qualified person for repair.

Battery packs

- Before charging, read the instructions.
- For indoor use. Do not expose to rain.
- Only use Draper XP20 battery packs with this product. Consult your Draper stockist for details.
- Do not charge any other manufacturer's battery packs using Draper chargers. Any other application is considered misuse.
- The battery must be removed from the appliance before it is recycled.
- The charger must be disconnected from the supply mains when removing the battery.
- The battery is to be disposed of in-line with local authority procedures.
- Do not use any other than the designated Draper batteries/chargers with this product.
- Do not crush, open or burn the battery. Exposure to potentially harmful materials may occur.
- In case of fire use CO₂ or dry chemical extinguisher.
- Do not expose to high temperatures >50°C. The battery may degrade at high temperatures.
- Charge battery in conditions between 5°C to 30°C with the specified charger designed for this battery.
- Do not use battery if it has been stored at 5°C or less. Allow it to "normalise" at room temperature before usage/charging.

Warning!

- Leaking battery packs
 - The electrolyte in battery packs is corrosive. Avoid contact with the skin.
 - If contact is made, flush the area with running water, pat dry and seek medical attention and advice at the earliest opportunity.
 - Inform medical personnel that the contaminant is a "high alkaline, corrosive liquid".
 - If electrolyte comes into contact with the eyes, flush with copious amounts of water only. Seek medical attention immediately, relaying the information above.

5. HEALTH AND SAFETY INFORMATION

5.7 CONNECTION TO THE POWER SUPPLY (CHARGER)

Note: This power product is supplied “bare”, without battery pack or charger. Draper Expert XP20 battery packs and chargers are available separately through all local Draper Tools stockists.

Caution: Risk of electric shock. Do not open.

This appliance is supplied with a moulded 3 pin mains plug for your safety. The value of the fuse fitted is marked on the pin face of the plug. Should the fuse need replacing, ensure the substitute is of the correct rating, approved to BS1362 and ASTA or BSI Kite marked.

ASTA 

BSI 

The fuse cover is removable with a small plain slot screwdriver. Ensure the fuse cover is replaced before attempting to connect the plug to an electrical outlet. If the cover is missing, a replacement must be obtained or the plug replaced with a suitable type.

If a replacement plug is to be fitted this must be carried out by a qualified electrician.

The damaged or incomplete plug, when cut from the cable should be disabled to prevent connection to a live electrical outlet.

This appliance is Class II[†] and is designed for connection to a power supply matching that detailed on the rating label and compatible with the plug fitted.

If an extension lead is required, use an approved and compatible lead rated for this appliance.

Follow all the instructions supplied with the extension lead.

[†]*Double insulated* : This product requires no earth connection as supplementary insulation is applied to the basic insulation to protect against electric shock in the event of failure of the basic insulation.

IMPORTANT

If using an extension lead, follow the instructions that came with your lead regarding maximum load while cable is wound. If in doubt, ensure that the entire cable is unwound. Using a coiled extension lead will generate heat which could melt the lead and cause a fire.

6. TECHNICAL DESCRIPTION

6.1 IDENTIFICATION

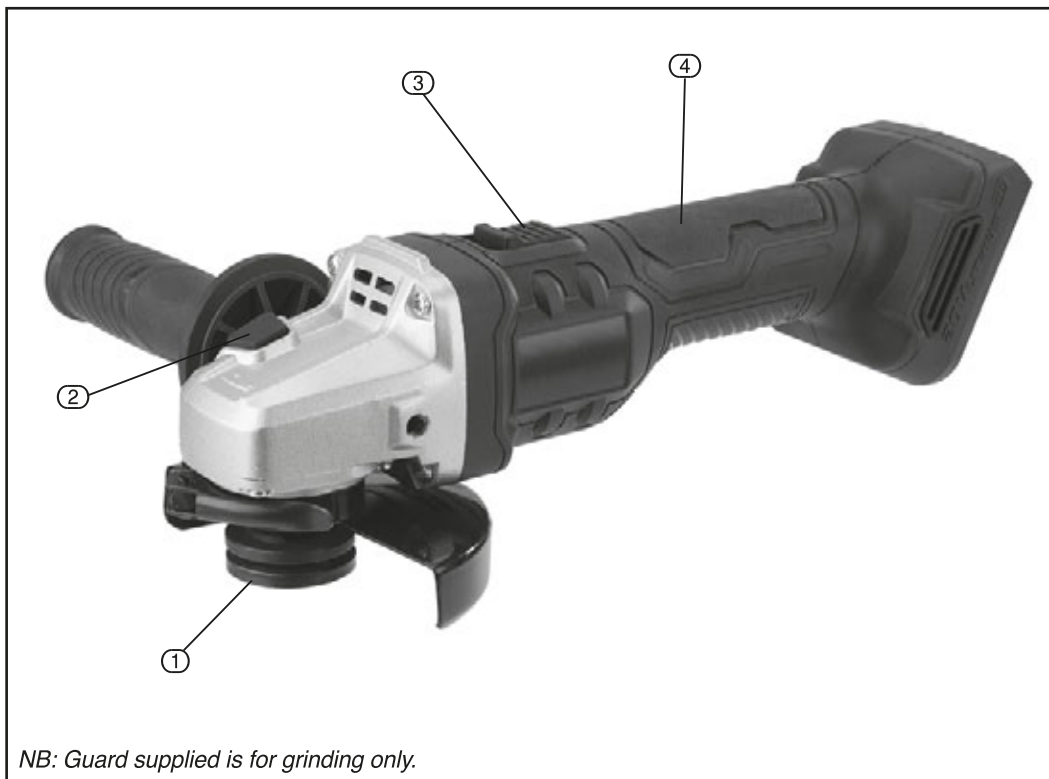

- ① Locking flange.
- ② Spindle lock.
- ③ On/off switch.
- ④ Soft grip.

7. UNPACKING AND CHECKING

7.1 PACKAGING

Carefully remove the product from the packaging and examine it for any sign of damage that may have happened during shipping. Lay the contents out and check them against the parts shown below. If any part is damaged or missing, please contact the Draper Help Line (the telephone number appears on the Title page) and do not attempt to use the product.

The packaging material should be retained at least during the warranty period, in case the machine needs to be returned for repair.

Warning!

- Some of the packaging materials used may be harmful to children. Do not leave any of these materials in the reach of children.
- If any of the packaging is to be thrown away, make sure they are disposed of correctly, according to local regulations.

7.2 XP20 MULTI-TOOL INTERCHANGEABLE BATTERY SYSTEM

The XP20 range of tools are a range of tools intended for trade use and has the quality and features to meet and exceed the expectations of the most demanding user, featuring a wide array of machines all running from the same range of batteries.

Many different capacity batteries are available making sure you can balance tool weight with longevity and find a battery that meets your needs.

To find out the latest range of accessories including batteries and chargers please consult the Draper website for more information or to find your local Draper stockist.



7.3 WHAT'S IN THE BOX

As well as the main product, there are also several other parts not fitted or attached to it:

- ⑤ Adjustable grinding guard.
- ⑥ 2 Position side handle.
- ⑦ Disc changing spanner.

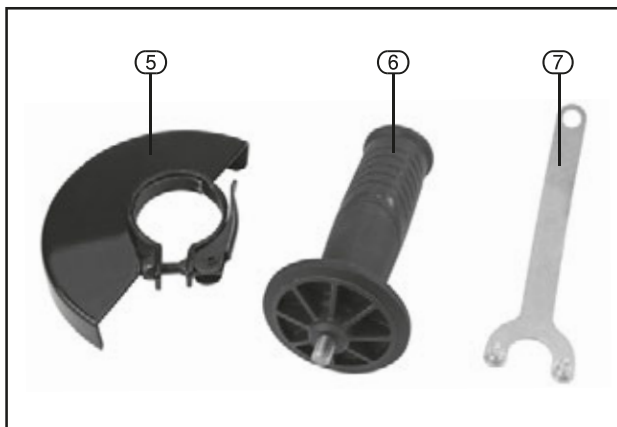

8. PREPARING THE ANGLE GRINDER

8.1 BATTERY PACK CHARGING – FIGS. 1 – 2

Note: This power product is supplied “bare”, without battery pack or charger. Draper Expert XP20 battery packs and chargers are available separately through all local Draper Tools stockists.

Important: Only XP20 Draper Expert designated battery packs and chargers can be used in conjunction with this product. Use of any other third party battery packs/chargers with this product is considered misuse and will invalidate the product’s warranty.

Once connected to the mains supply, recharging of the battery can be left generally unsupervised, requiring minimal attention. Complex circuit construction monitors the battery condition, adjusting the recharge current to suit. When the recharge cycle is complete, to maintain the full capacity, a low output current will continue as required.

Warning! Check the condition of the charger and battery prior to each charge. If there is any sign of damage then do not commence charging, seek advice from Draper Tools.

The battery pack is supplied uncharged and must be charged before initial use.

To charge the battery pack, it must first be removed from the tool.

To release the battery pack (14):

- Press the battery release button (14.1) and gently slide the battery pack off (Fig.1).
- Plug the battery charger (13) unit into a 230V/AC 13amp three pin supply socket.
- The red LED (13.1) will illuminate to show the charger has power.
- Slide the battery into the charger (the battery is shaped to fit into the charger one way only).
- After a few seconds delay, the green LED (13.2) will illuminate to show that charging has begun. The red light stays solid red.
- Whilst the battery is charging, the green LED (13.2) stays solid.
- When the battery is fully charged the green LED starts flashing. The red LED will remain solid.

Caution: Do not pull the plug out of the power supply by pulling on the cord. Make sure to grasp the plug when removing from power supply to avoid damaging the cord.

To remove the battery from the battery charger:

- Supporting the battery charger with hand, pull out the battery from the battery charger.

Caution: If the battery charger has been in continuous use it will be hot. Once the charging has been completed, leave the charger 15 minutes to cool until next use.

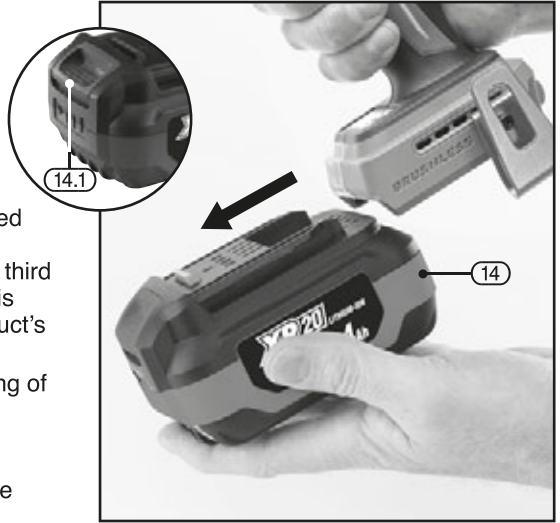

FIG.1 XP20 4.0Ah battery pack (56319) shown.



FIG.2

8. PREPARING THE ANGLE GRINDER

If the battery is charged when it is warm due to battery use or exposure to sunlight, the battery will not be recharged. In such a case, let the battery cool before charging.

If both the red and green indicators flicker rapidly at 0.2 second intervals, check or and remove any foreign objects in the charger's battery slot. If there are no foreign objects, it is probable that the battery or charger is malfunctioning. Allow battery/charger to normalise and try again. If a fault remains after trying this then contact Draper Tools.

8.2 BATTERY PACK PROTECTION FEATURES

Overcharging protection: This feature that ensures that the battery pack can never be overcharged. When the battery pack reaches full charge capacity, the transformer/charger will automatically shut off, protecting the internal components from being damaged.

Over-discharging protection: This feature will stop the battery pack from discharging beyond the recommended lowest safety voltage.

Overheating protection: The battery pack contains an internal thermistor cut-off sensor which shuts off the battery pack should it become too hot during operation. This can happen if the tool is overloaded or being used for extended periods. Up to 30 minutes cooling time may be required, depending on ambient temperature.

Current protection: Should the battery be overloaded and the maximum current draw be exceeded, the battery will shut off to protect the internal components. The battery pack will resume working once excessive current draw has returned to normal, safe level.

Short circuit protection: If, for any reason, the battery pack was to short circuit, the short circuit protection would immediately stop the battery pack from operating.

8.3 BATTERY PACK CHARGE STATUS – FIG. 3

To display the amount of charge left in the battery pack, press the charge level indicator button (14.2).

8.4 BATTERY LIFE EFFICIENCY AND CHARGING ADVICE

– Avoid recharging at high temperatures.

A rechargeable battery will be hot immediately after use. If such a battery is recharged immediately after use, its internal chemical substance will deteriorate, and the battery life will be shortened. Leave the battery and recharge it after it has cooled for a while.

– The battery should only be used and/or charged when battery temperature is between 5°C and 30°C.

– The battery needs to be warmed-up or cooled down in order to prevent damage to the batteries internal components.

Note: If battery is too hot or too cold, allow it to 'normalise' before use or charging.

Note: Failure to warm up or cool down a battery could result in serious damage to the battery, charger and user.

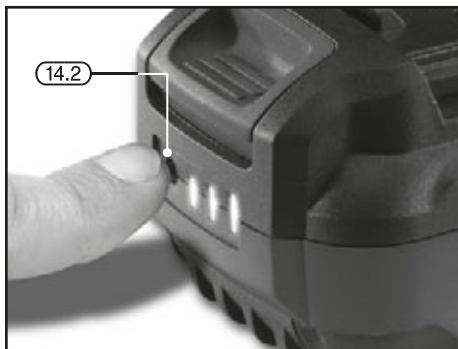

XP20 4.0Ah battery pack (56319) shown.

Charge level indicator	Amount of charge remaining
	0 – 10%
	10 – 40%
	40 – 70%
	70 – 100%

FIG.3

The battery pack will resume working once excessive current draw has returned to normal, safe level.

9. PREPARING THE ANGLE GRINDER

9.1 FITTING AUXILIARY HANDLES - FIG. 1

Note: Remove the battery from the machine before carrying out adjustment, servicing or maintenance. For reasons of safety, when working with this type of electric power tool, the operator must always use the auxiliary handle (6).

Screw the handle clockwise, into one of the two threaded apertures best suited to the application and user comfort.

Warning: This machine must never be operated without the appropriate guard in place correctly fitted and operating fully.

9.2 FITTING THE GUARD - FIG. 2

Position the guard (5) onto the grinder collar with the quick release lever in the open position (fig.2.) rotate the guard until it is in the correct position to line up the cutout, once fully located the guard can be rotated to any position*. To remove, the guard must be rotated until the spigot lines up with the cutout again and* then close the quick release lever to lock the guard in the correct position.

Warning: Never attempt to operate this machine without the guard securely fitted and correctly positioned*.

* With the exception of wire cup brushes etc. which negate the guards effectiveness.

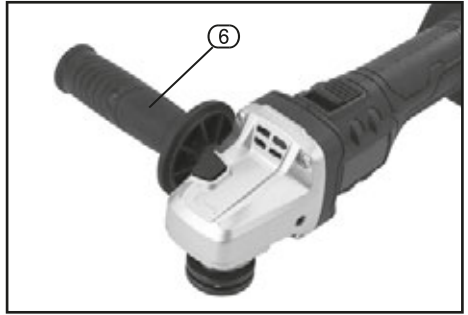

FIG.1

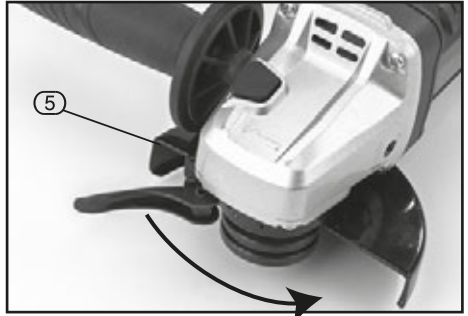

FIG.2

9. PREPARING THE ANGLE GRINDER

9.3 FITTING/REPLACING ACCESSORIES (sold separately)

Warning! Prior to mounting an abrasive wheel ensure the expiry date has not expired, rendering it potentially hazardous.

Warning! Selection of the correct accessory, suitable for the intended application is vital. Seek guidance if uncertain of selection.

Warning! The rated (no load) revolutions per minute of the tool must not exceed the speed capacity of the accessory. Please refer to the accessory manufacturers instructions for information.

Visual Inspection:

- Prior to fitting, abrasive/superabrasive wheels shall be subject to a visual inspection.

Inspection:

- Each time after mounting, the abrasive/superabrasive wheel shall be test run for a reasonable time.
- The specified maximum operating speed of the wheel shall not be exceeded.
- Damaged abrasives shall be destroyed.
- Always wear approved safety goggles.



Important information:

B, C, D (FIG.3):

- For cutting applications, and to comply to current legislation, it is necessary to replace the "grinding" guard supplied with this machine with a "cutting" guard (Please consult the Draper website or your local stockist for details).

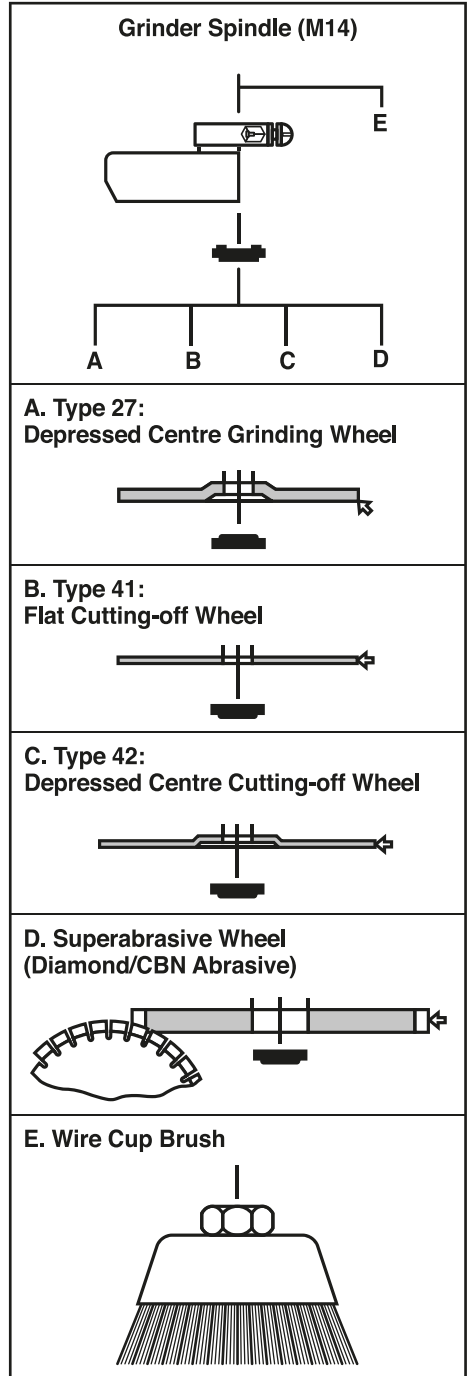

9. PREPARING THE ANGLE GRINDER

9.4 FITTING GRINDING DISCS - FIGS. 3 – 5

Press and hold the spindle lock button (2). Loosen the locking flange (1) anti-clockwise using the pin spanner (7) supplied. The spindle may rotate slightly before the spindle lock fully engages. Remove the locking flange only. Clean the flanges and spindle prior to fitting any accessory. If the rear flange is removed for cleaning, ensure it locates correctly on the spindle flats when refitting and does not spin freely. When fitting the appropriate accessory please refer to (Fig.3) for specific details on the locking flange correct orientation as applicable.

Securely tighten the locking flange clockwise using the disc changing spanner (8) while holding down the spindle lock (3).

Note: When using wire cup brushes the locking flange is not required due to the design of the brushes. When fitted check the accessory is correct and, importantly fully secure on the spindle.

Warning: Never press the spindle lock button (2) while the spindle is in motion.

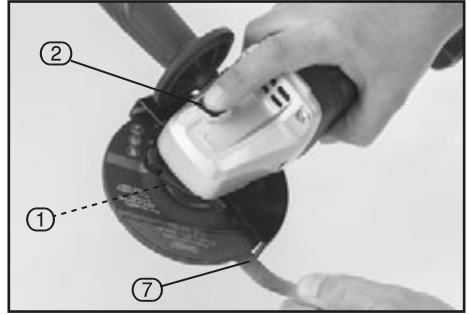

FIG.3



FIG.4

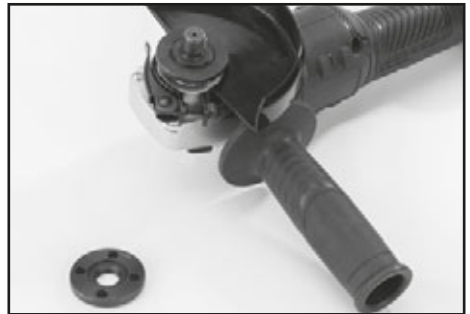

FIG.5

10. BASIC ANGLE GRINDER OPERATIONS

10.1 ON/OFF SWITCH - FIG. 6

- Push the switch (3) forward to start the grinder.
- Push the switch further forwards and down to lock it in the 'ON' position.
- To stop the grinder, release the switch by pushing down on the back of the switch (3).

Note: To prevent accidental starting in a situation of power failure to the grinder, the 'ON/OFF' switch (13) is fitted with a protective device that prevents the angle grinder from starting up automatically when the power is re-established. In this case, and with the power re-established, release the switch to the 'OFF' position, then switch to 'ON' as normal.

Warning! Do not set the machine down until the spindle has completely stopped.

Note: During use, keep clothing out of the line of any sparks formed. Sparks from metal grinding can set fire to many types of clothing in a short time. The risk is less if your outer clothing is made of wool, or flame retardant treated cotton.

Dust

A correctly fitted dust mask, suitable for the activity and in accordance to the relevant standard, must be worn.

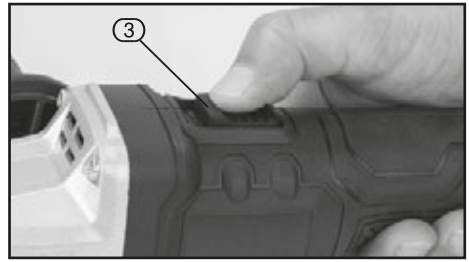

FIG.6

10.2 GRINDING

When performing grinding operations maintain an angle of approximately 30° between the work surface and the disc face.

Only use abrasives specifically designed for this task.

10.3 CUTTING



Important legal information:

- Cutting operations should only be attempted with the "cutting" guard fitted to this grinder.
- Please contact Draper Tools for further information on how to purchase this optional accessory.
- This guard must be fitted for your safety.
- When performing cutting-off operations do not incline the machine as this can lead to the abrasive wheel becoming jammed, damaged or excessively and abnormally worn.
- Only use abrasives specifically designed for this task.

Warning! As the abrasive wheel wears during use, its diameter reduces. This reduces the peripheral speed and the machine's efficiency. This results in increased load on the grinding machine which if continued will damage the motor. Ensure that the diameter of the wheel is within 25% of its original size.

Important: Excessive pressure on the machine does not result in a higher abrasive efficiency. Excessive pressure increases wear and tear on the accessory and will damage the angle grinder which is not covered under the warranty.

11. MAINTENANCE AND TROUBLESHOOTING

11.1 MAINTENANCE

Regular inspection and cleaning reduces the necessity for maintenance operations and will keep your tool in good working condition.

The motor must be correctly ventilated during tool operation. Avoid blocking the air inlets and vacuum the ventilation slots regularly.

11.2 TROUBLESHOOTING

Problem	Possible Cause	Remedy
Motor does not start.	<ul style="list-style-type: none">- Battery pack no charge.- Battery faulty or damaged	<ul style="list-style-type: none">- Re-charge battery.- Replace battery.
Machine vibrates.	<ul style="list-style-type: none">- Wheel damaged or out of balance.- Wheel loose.	<ul style="list-style-type: none">- Replace wheel.- Stop machine immediately – when stopped, refit accessory.
Wheel will not cut/grind.	<ul style="list-style-type: none">- Incorrect disc fitted.	<ul style="list-style-type: none">- Fit correct disc for material/application.

Important: Please note, all repairs/service should be carried out by a qualified person.

12. OPTIONAL ACCESSORIES

12.1 OPTIONAL ACCESSORIES

A full range of accessories are available from Draper Tools.

Please visit our website for details: www.drapertools.com

13. DISPOSAL

13.1 DISPOSAL

- At the end of the machine's working life, or when it can no longer be repaired, ensure that it is disposed of according to national regulations.
- Contact your local authority for details of collection schemes in your area.

In all circumstances:

- Do not dispose of power tools with domestic waste.
- Do not incinerate.
- Do not dispose of WEEE* as unsorted municipal waste.



Li-ion

* *Waste Electrical & Electronic Equipment.*

13.2 BATTERY PACK DISPOSAL INFORMATION

Warning!

- Do not put battery pack in fire or mutilate – cells may burst or release toxic materials.
- Do not short circuit cells, may cause burns.
- The battery pack must be removed from the appliance before it is scrapped.
- The battery pack is to be disposed of safely.
- Do not mutilate batteries, corrosive electrolyte will be released.
- Do not dispose of batteries or cells in a charged condition.

Expired batteries must be recycled/disposed of in accordance with the appropriate regulation or legislation. They should be returned to your local warranty agent/stockist.

14. EXPLANATION OF SYMBOLS

14.1 EXPLANATION OF SYMBOLS



Read the instruction manual.



Wear face mask and safety glasses.



Wear ear defenders.



Do not abandon into the environment.



Keep out of the reach of children.



Warning!



Single value noise marking.
(Maximum declared A-Weighted sound power level in decibels).



Class II construction
(Double insulated).



WEEE –
Waste Electrical & Electronic Equipment.
Do not dispose of Waste Electrical & Electronic Equipment in with domestic rubbish.



For indoor use only.
Do not expose to rain.



Short-circuit-proof safety isolating transformer



Fuse.



Polarity indication.



Rated voltage.

CONTACTS

Draper Tools Limited, Hursley Road,
Chandler's Ford, Eastleigh, Hampshire. SO53 1YF. U.K.

Help line: (023) 8049 4344

Sales Desk: (023) 8049 4333

Internet: drapertools.com

E-mail: sales@drapertools.com

General Enquiries: (023) 8026 6355

Service/Warranty Repair Agent:

For aftersales servicing or warranty repairs, please contact the Draper Tools Help line for details of an agent in your local area.

YOUR DRAPER STOCKIST

TAKC0119

©Published by Draper Tools Limited.

No part of this publication may be reproduced, stored in a retrieval system or transmitted in any form or by any means, electronic, mechanical photocopying, recording or otherwise without prior permission in writing from Draper Tools Ltd.