

DRAPER[®]
Expert

GB

3 Year
WARRANTY

230V 5.2KG

SDS+ ROTARY HAMMER DRILL

56405



These instructions accompanying the product are the original instructions. This document is part of the product, keep it for the life of the product passing it on to any subsequent holder of the product. Read all these instructions before assembling, operating or maintaining this product.

This manual has been compiled by Draper Tools describing the purpose for which the product has been designed, and contains all the necessary information to ensure its correct and safe use. By following all the general safety instructions contained in this manual, it will ensure both product and operator safety, together with longer life of the product itself.

All photographs and drawings in this manual are supplied by Draper Tools to help illustrate the operation of the product.

Whilst every effort has been made to ensure the accuracy of information contained in this manual, the Draper Tools policy of continuous improvement determines the right to make modifications without prior warning.

1. TITLE PAGE

1.1 INTRODUCTION:

USER MANUAL FOR: 230V 5.2kg SDS+ Rotary Hammer Drill

Stock No: 56405

Part No: SDSHD1500E

1.2 REVISIONS:

Date first published September 2018.

As our user manuals are continually updated, users should make sure that they use the very latest version.

Downloads are available from: <http://drapertools.com/manuals>

Draper Tools Limited

Hursley Road

Chandler's Ford

Eastleigh

Hampshire

SO53 1YF

UK

Website: drapertools.com

Product Helpline: +44 (0) 23 8049 4344

General Fax: +44 (0) 23 8026 0784

1.3 UNDERSTANDING THIS MANUALS SAFETY CONTENT:

WARNING! – Information that draws attention to the risk of injury or death.

CAUTION! – Information that draws attention to the risk of damage to the product or surroundings.

1.4 COPYRIGHT © NOTICE:

Copyright © Draper Tools Limited.

Permission is granted to reproduce this publication for personal and educational use only. Commercial copying, redistribution, hiring or lending is prohibited.

No part of this publication may be stored in a retrieval system or transmitted in any other form or means without written permission from Draper Tools Limited.

In all cases this copyright notice must remain intact.

2. CONTENTS

1	TITLE PAGE	
1.1	INTRODUCTION	2
1.2	REVISION HISTORY	2
1.3	UNDERSTANDING THIS MANUAL	2
1.4	COPYRIGHT NOTICE.....	2
2	CONTENTS	
2.1	CONTENTS.....	3
3	WARRANTY	
3.1	WARRANTY.....	4
4	INTRODUCTION	
4.1	SCOPE	5
4.2	SPECIFICATION	5
4.3	HANDLING AND STORAGE	5
5	HEALTH AND SAFETY INFORMATION	
5.1	GENERAL SAFETY INSTRUCTIONS FOR POWER TOOL USE	6
5.2	ADDITIONAL SAFETY INSTRUCTIONS FOR HAMMER DRILLS	7
5.3	RESIDUAL RISK	8
5.4	CONNECTION TO THE POWER SUPPLY.....	8
6	TECHNICAL DESCRIPTION	
6.1	IDENTIFICATION	9
7	UNPACKING AND CHECKING	
7.1	PACKAGING	10
7.2	WHAT'S IN THE BOX.....	10
8	PREPARING THE DRILL	
8.1	AUXILIARY HANDLE	11
9	BASIC HAMMER DRILL OPERATIONS	
9.1	ROTARY/HAMMER AND DRILLING/CHISELLING SELECTOR SWITCHES	12
9.2	ROTARY DRILLING	12
9.3	HAMMER DRILLING	13
9.4	CHISELLING (NON-ROTATING)	13
9.5	CHISELLING (ROTATIONAL)	14
9.6	TRIGGER SWITCH.....	14
9.7	SDS+ SYSTEM	15
9.8	DUST AND SWARF	15
9.9	DRILLING WOOD, PLASTIC OR METAL	15
10	MAINTENANCE AND TROUBLESHOOTING	
10.1	GEARBOX MAINTENANCE	16
10.2	TROUBLESHOOTING GUIDE.....	16
11	OPTIONAL ACCESSORIES	
11.1	OPTIONAL ACCESSORIES.....	17
12	DISPOSAL	
12.1	DISPOSAL.....	18
13	EXPLANATION OF SYMBOLS	
13.1	EXPLANATION OF SYMBOLS	19
	DECLARATION OF CONFORMITY	ENCLOSED

3. WARRANTY

3.1 WARRANTY

Draper tools have been carefully tested and inspected before shipment and are guaranteed to be free from defective materials and workmanship.

Should the tool develop a fault, please return the complete tool to your nearest distributor or contact:

Draper Tools Limited, Chandler's Ford, Eastleigh, Hampshire, SO53 1YF. England.

Telephone Sales Desk: (023) 8049 4333 or:

Product Helpline (023) 8049 4344.

A proof of purchase **must** be provided.

If upon inspection it is found that the fault occurring is due to defective materials or workmanship, repairs will be carried out free of charge. This warranty period covering labour is 12 months from the date of purchase except where tools are hired out when the warranty period is 90 days from the date of purchase. The warranty is extended to 24 months from the date of purchase for parts only. This warranty does not apply to any consumable parts, any type of battery or normal wear and tear, nor does it cover any damage caused by misuse, careless or unsafe handling, alterations, accidents, or repairs attempted or made by any personnel other than the authorised Draper warranty repair agent.

Draper Tools Limited takes pride in the quality of its products and the services offered to our valued customers. As a result we offer a free, 3 year extended warranty for this product.

REGISTER WITHIN 30 DAYS TO CLAIM YOUR

FREE



*To register your warranty, visit: **drapertools.com/warranty-registration**

or call our Customer Helpline on: **(023) 8049 4344**

By registering your product you'll automatically become a Draper Club Member where you will have the option to receive news of our new products, offers, deals, competitions and more!

If you are unable to register online, please call our Customer Helpline on the number shown above. Full registration must be completed within 30 days from receipt of purchase. The 3 year extended warranty only applies to permanent UK residents, to the original product purchased from an authorised Draper Tools stockist for use in their appropriate profession/trade. This warranty is not valid to purchasers reselling or hiring the product. This warranty is not transferrable and is only available to the original product purchaser who has completed their registration and is a Draper Club Member. The 3 year extended warranty period starts from the date of purchase and is not extended following an inspection, repair or replacement.

Note: If the tool is found not to be within the terms of warranty, repairs and carriage charges will be quoted and made accordingly.

This warranty applies in lieu of any other warranty expressed or implied and variations of its terms are not authorised.

Your Draper warranty is not effective unless you can produce upon request a dated receipt or invoice to verify your proof of purchase within the warranty period.

Please note that this warranty is an additional benefit and does not affect your statutory rights.

Draper Tools Limited.

For full terms and conditions visit: drapertools.com/corporate-policies

4. INTRODUCTION

4.1 SCOPE

For impact drilling/chiselling into brick, concrete and stone as well as for drilling in wood, metal and plastic.

This product is intended for trade use and has the quality and features to meet and exceed the expectations of the most demanding user. Any application other than that it was intended for, is considered misuse.

4.2 SPECIFICATION

Stock no.	56405
Part no.	SDSHD1500E
Rated voltage	230V~50Hz
Rated input	1500W
Drilling capacity:	
Masonry	32mm
Wood	43mm
Mild steel	13mm
Impact force.....	5.5 Joules
Revolutions per minute (no load)	860r/min
Impact rate	4250b/min
Chuck type	SDS+
Sound pressure level (LpA)*:	92.7dB(A)
Sound power level (LWA)**:	103.7dB(A)
Uncertainty (K):	3dB(A)
Vibration level:	
Drilling into concrete	17.36m/s ² , K=1.5m/s ²
Chiselling into concrete	13.334m/s ² , K=1.5m/s ²
Weight (drill only).....	5.2kg

* *Continuous A-Weighted Sound Pressure Level at the workstation in accordance to and declared according to EN60745.*

** *The typical A-weighted noise level determined according to EN60745.*

4.3 HANDLING AND STORAGE

- Care must be taken when handling this product.
 - Dropping this power tool could have an effect on its accuracy and could also result in personal injury. This product is not a toy and must be respected.
- Environmental conditions can have a detrimental effect on this product if neglected.
 - Exposure to damp air can gradually corrode components.
 - If the product is unprotected from dust and debris, components will become clogged.
 - If not cleaned and maintained correctly or regularly, the machine will not perform at its best.

5. HEALTH AND SAFETY INFORMATION

5.1 GENERAL SAFETY INSTRUCTIONS FOR POWER TOOL USE

When using any type of power tool there are steps that should be taken to make sure that you, as the user, remain safe.

Common sense and a respect for the tool will help reduce the risk of injury.

Read the instruction manual fully. Do not attempt any operation until you have read and understood this manual.

Most important you must know how to safely start and stop this machine, especially in an emergency.

Keep the work area tidy and clean. Attempting to clear clutter from around the machine during use will reduce your concentration. Mess on the floor creates a trip hazard. Any liquid spilt on the floor could result in you slipping.

Find a suitable location. If the machine is bench mounted, the location should provide good natural light or artificial lighting as a replacement. Avoid damp and dust locations as it will have a negative effect on the machine's performance. If the machine is portable do not expose the tool to rain. In all cases do not operate power tools near any flammable materials.

Keep bystanders away. Children, onlookers and passers by must be restricted from entering the work area for their own protection. The barrier must extend a suitable distance from the tool user.

Unplug and house all power tools that are not in use. A power tool should never be left unattended while connected to the power supply. They must be housed in a suitable location, away locked up and from children. This includes battery chargers.

Do not overload or misuse the tool. All tools are designed for a purpose and are limited to what they are capable of doing. Do not attempt to use a power tool (or adapt it in any way) for an application it is not designed for. Select a tool appropriate for the size of the job. Overloading a tool will result in tool failure and user injury. This covers the use of accessories.

Dress properly. Loose clothing, long hair and jewellery are all dangerous because they can become entangled in moving machinery. This can also result in parts of body being pulled into the machine. Clothing should be close fitted, with any long hair tied back and jewellery and neck ties removed. Footwear must be fully enclosed and have a non-slip sole.

Wear personal protective equipment (PPE). Dust, noise, vibration and swarf can all be dangerous if not suitably protected against. If the work involving the power tool creates dust or fumes wear a dust mask. Vibration to the hand, caused by operating some tools for longer periods must be protected against. Wear vibration reducing gloves and allow long breaks between uses. Protect against dust and swarf by wearing approved safety goggles or a face shield. These are some of the more common hazards and preventions, however, always find out what hazards are associated with the machine/work process and wear the most suitable protective equipment available.

Do not breathe contaminated air. If the work creates dust or fumes connect the machine (if possible) to an extraction system either locally or remotely. Working outdoors can also help if possible.

Move the machine as instructed. If the machine is hand held, do not carry it by the power supply cable. If the product is heavy, employ a second or third person to help move it safely or use a mechanical device. Always refer to the instructions for the correct method.

Do not overreach. Extending your body too far can result in a loss of balance and you falling. This could be from a height or onto a machine and will result in injury.

Maintain your tools correctly. A well maintained tool will do the job safely. Replace any damaged or missing parts immediately with original parts from the manufacturer. As applicable, keep blades sharp, moving parts clean, oiled or greased, handles clean, and emergency devices working.

Wait for the machine to stop. Unless the machine is fitted with a safety brake, some parts may continue to move due to momentum. Wait for all parts to stop, then unplug it from the power supply before making any adjustments, carrying out maintenance operations or just finishing using the tool.

5. HEALTH AND SAFETY INFORMATION

Remove and check setting tools. Some machinery requires the use of additional tools or keys to set, load or adjust the power tool. Before starting the power tool always check to make certain they have been removed and are safely away from the machine.

Prevent unintentional starting. Before plugging any machine in to the power supply, make sure the switch is in the OFF position. If the machine is portable, do not hold the machine near the switch and take care when putting the machine down, that nothing can operate the switch.

Carefully select an extension lead. Some machines are not suitable for use with extension leads. If the tool is designed for use outdoors, use an extension lead also suitable for that environment. When using an extended lead, select one capable of handling the current (amps) drawn by the machine in use. Fully extend the lead regardless of the distance between the power supply and the tool. Excess current (amps) and a coiled extension lead will both cause the cable to heat up and can result in fire.

Concentrate and stay alert. Distractions are likely to cause an accident. Never operate a power tool if you are under the influence of drugs (prescription or otherwise), including alcohol or if you are feeling tired. Being disorientated will result in an accident.

Have this tool repaired by a qualified person. This tool is designed to conform to the relevant international and local standards and as such should be maintained and repaired by someone qualified, using only original parts supplied by the manufacturer. This will ensure the tool remains safe to use.

5.2 ADDITIONAL SAFETY INSTRUCTIONS FOR HAMMER DRILLS

Important: Draper Tools Limited recommends that this machine should not be modified or used for any application other than that for which it was designed. If you are unsure of its relative applications do not hesitate to contact us in writing and we will advise you.

- Power tools shall not be used in potentially explosive atmospheres unless specifically designed for that purpose.
- Unexpected tool movement due to reaction forces or breakage may cause injuries.
- Power tools shall be isolated from the energy source before changing or adjusting the inserted tool.

Warning!

- Wear appropriate ear protection. Exposure to noise can lead to hearing loss.
- There is a risk of loose clothing, hair etc., being caught in the rotating spindle of the power tool.
- Do not touch the drill bit or areas close to the drill bit immediately after use; they can still be extremely hot, causing burns.
- Be sure the drill bit is securely in place before using the drill.
- There is a risk of release of toxic chemicals into the atmosphere when using certain materials. Always be mindful to use the appropriate personal protective wear to help safeguard against potential skin contact and dust inhalation. Always consult and follow the material supplier's safety guidelines.
- Adopt a suitable posture to counteract normal or unexpected movement of the power tool due to reaction forces from the power assembly tool.
- Do not modify this product in any way. Any other application is considered misuse and will invalidate the warranty.

5. HEALTH AND SAFETY INFORMATION

5.3 RESIDUAL RISK

Important note: Although the safety instructions and operating manuals for our tools contain extensive instructions of safe working with power tools, every power tool involves a certain residual risk which can not be completely excluded by safety mechanisms. Power tools must therefore always be operated with caution!

5.4 CONNECTION TO THE POWER SUPPLY

Caution: Risk of electric shock. Do not open.

This appliance is supplied with a moulded 3 pin mains plug for your safety. The value of the fuse fitted is marked on the pin face of the plug. Should the fuse need replacing, ensure the substitute is of the correct rating, approved to BS1362 and ASTA or BS Kite marked.

ASTA 

BSI 

The fuse cover is removable with a small plain slot screwdriver. Ensure the fuse cover is replaced before attempting to connect the plug to an electrical outlet. If the cover is missing, a replacement must be obtained or the plug replaced with a suitable type.

If a replacement plug is to be fitted this must be carried out by a qualified electrician.

The damaged or incomplete plug, when cut from the cable should be disabled to prevent connection to a live electrical outlet.

This appliance is Class II† and is designed for connection to a power supply matching that detailed on the rating label and compatible with the plug fitted.

If an extension lead is required, use an approved and compatible lead rated for this appliance. Follow all the instructions supplied with the extension lead.

†*Double insulated* : This product requires no earth connection as supplementary insulation is applied to the basic insulation to protect against electric shock in the event of failure of the basic insulation.

IMPORTANT

If using an extension lead, follow the instructions that came with your lead regarding maximum load while cable is wound. If in doubt, ensure that the entire cable is unwound. Using a coiled extension lead will generate heat which could melt the lead and cause a fire.

6. TECHNICAL DESCRIPTION

6.1 IDENTIFICATION

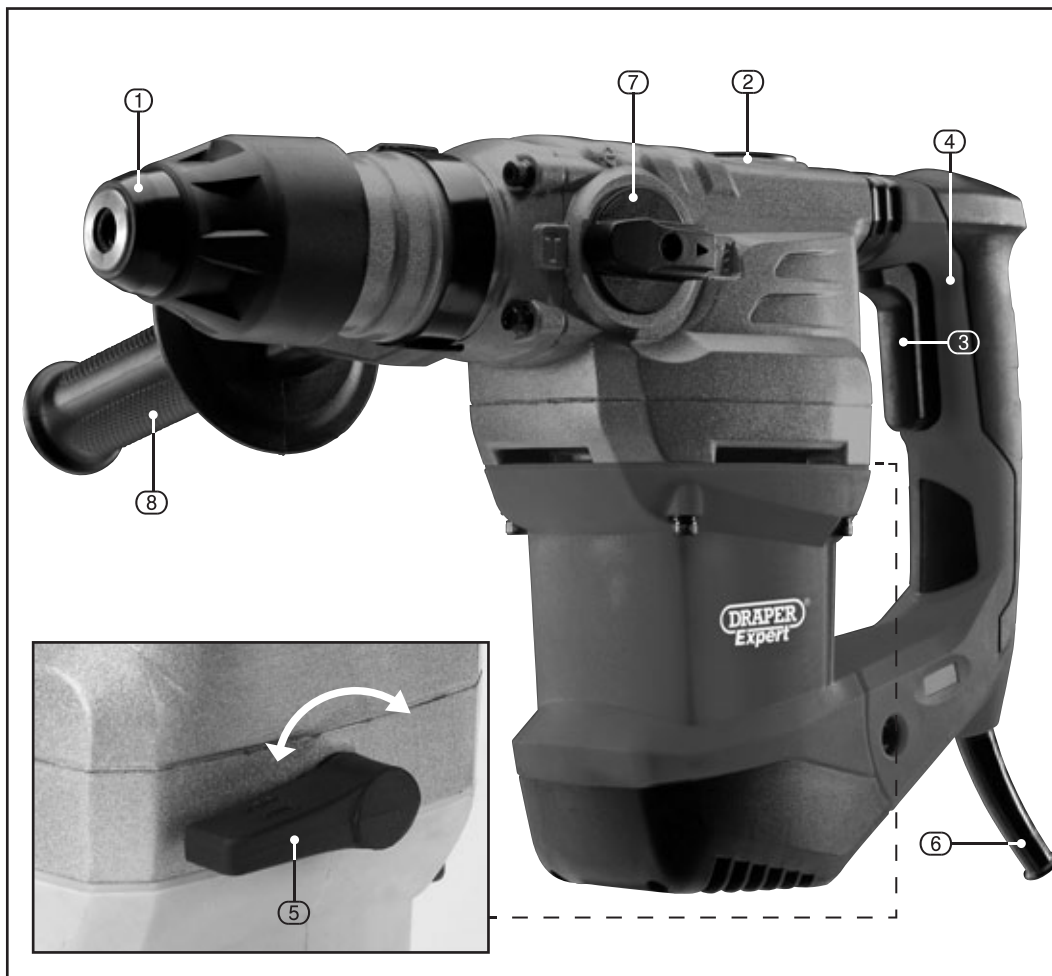

- ① SDS+ chuck.
- ② Gearbox access cover.
- ③ On/Off trigger switch.
- ④ Hand grip.
- ⑤ Rotary/hammer selector.
- ⑥ Plug and cable.
- ⑦ Drilling/chiselling selector.
- ⑧ Auxiliary handle.

7. UNPACKING AND CHECKING

7.1 PACKAGING

Carefully remove the product from the packaging and examine it for any sign of damage that may have happened during shipping. Lay the contents out and check them against the parts shown below. If any part is damaged or missing; please contact the Draper Help Line (the telephone number appears on the Title page) and do not attempt to use the product.

The packaging material should be retained at least during the warranty period: in case the machine needs to be returned for repair.

Warning! Some of the packaging materials used may be harmful to children. Do not leave any of these materials in the reach of children.

If any of the packaging is to be thrown away, make sure they are disposed of correctly; according to local regulations.

7.2 WHAT'S IN THE BOX

As well as the rotary hammer drill, there are several parts not fitted or attached to it.

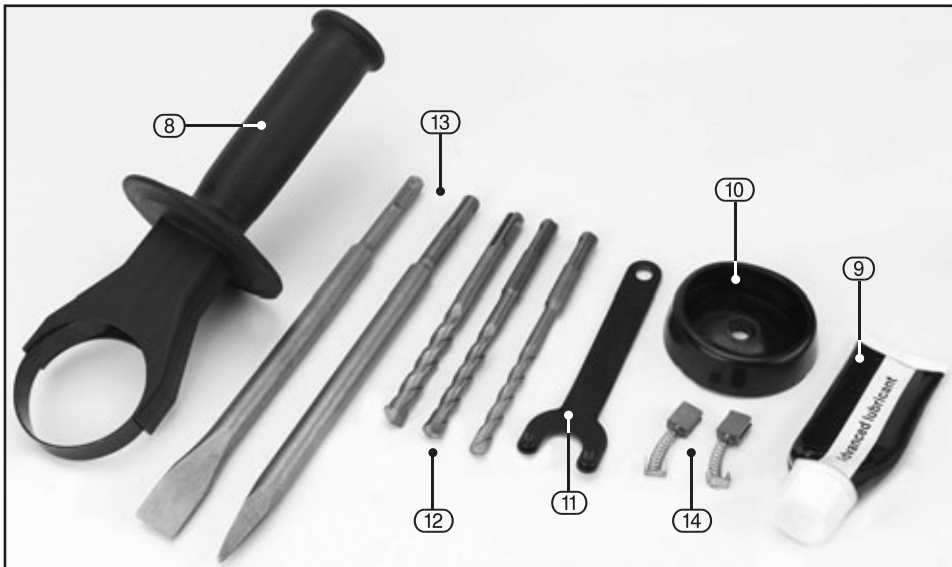

- ⑧ Auxiliary handle.
- ⑨ Grease.
- ⑩ Dust cover.
- ⑪ Pin spanner.
- ⑫ 150mm SDS+ drill bits × 3 (8, 10 and 12mmØ).
- ⑬ 250mm SDS+ chisels × 2 (flat and point).
- ⑭ Replacement carbon motor brushes.

8. PREPARING THE DRILL

Note: Remove the plug from the socket before carrying out adjustment, servicing or maintenance.

8.1 AUXILIARY HANDLE – FIG.1

Warning! Use auxiliary handle supplied with the tool. Loss of control can cause personal injury.

When fitting the auxiliary handle (8):

- Ensure the hand grip is loose (screw anti-clockwise to loosen) before sliding it over the drill's chuck onto the collar.
- Select the required angle of the handle and tighten the handgrip to secure.

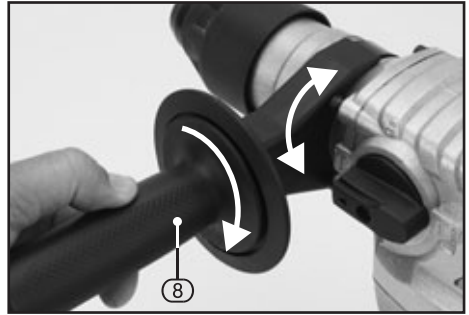

FIG.1

9. BASIC HAMMER DRILL OPERATIONS

Warning! Prior to beginning any drilling, carefully check the surface for the presence of electric cable, gas or water pipes and other dangerous or damaging contents. If unsure do not proceed.

Note: Remove the plug from the socket before carrying out adjustment, servicing or maintenance.

9.1 ROTARY/HAMMER AND DRILLING/CHISELLING SELECTOR SWITCHES – FIGS.2 – 3

The drilling/chiselling selector switch (7) and the rear rotary/hammer switch (5) can be used together in various combinations to achieve a variety of drilling and chiselling applications.

Note: The side selector switch (7) incorporates a safety button (7.1). Press the button in whilst rotating the switch to the desired position.

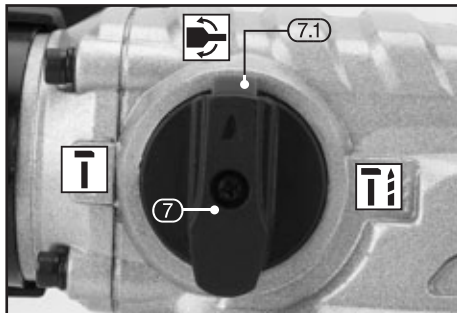

FIG.2

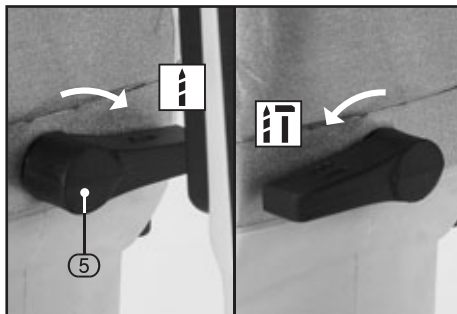

FIG.3

9.2 ROTARY DRILLING – FIGS.4 – 5

- Rotate the drilling/chiselling selector (7) to the hammer and drill setting.
- Switch the rotary/hammer selector (5) to the drill setting.

This setting is recommended when using the drill without hammer action.

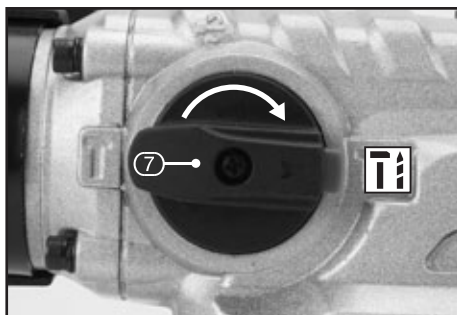

FIG.4

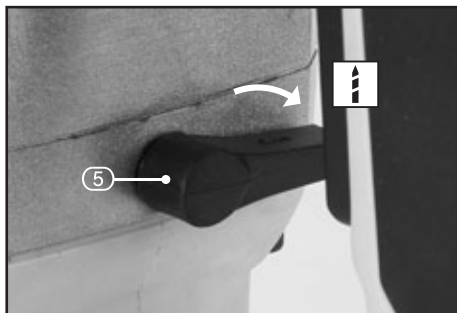

FIG.5

9. BASIC HAMMER DRILL OPERATIONS

9.3 HAMMER DRILLING – FIGS.6 – 7

- Rotate the drilling/chiselling selector (7) to the hammer and drill setting.
- Switch the rotary/hammer selector (5) to the drill and hammer setting.

This combination of settings is recommended for drilling holes in concrete and masonry. Hammer action will be in operation and the drill bit will rotate accordingly.

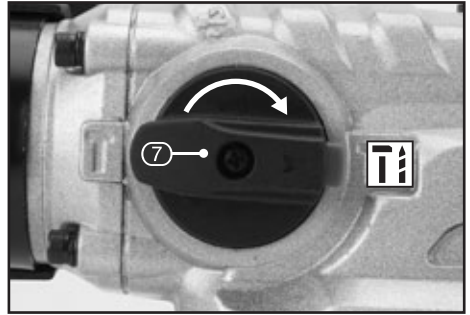

FIG.6

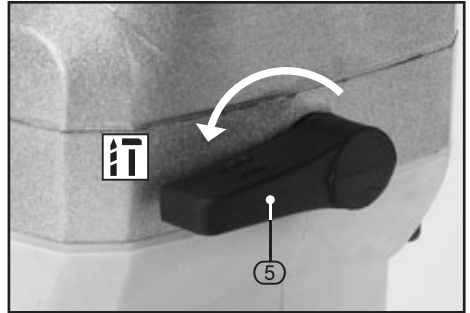

FIG.7

9.4 CHISELLING (NON-ROTATING) – FIGS.8 – 9

- Rotate the side drilling/chiselling selector (7) to the hammer setting.
- Switch the rotary/hammer selector (5) to the drill and hammer setting.

With this combination of settings, hammer action will be in operation, but without rotation of the chisel accessory. This operation is best suited for chiselling out or 'chipping off' masonry and brickwork, chasing out brickwork, plasterboard, etc.

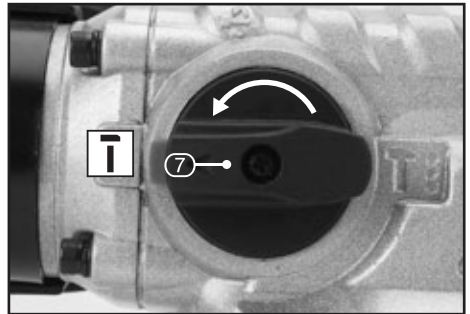

FIG.8

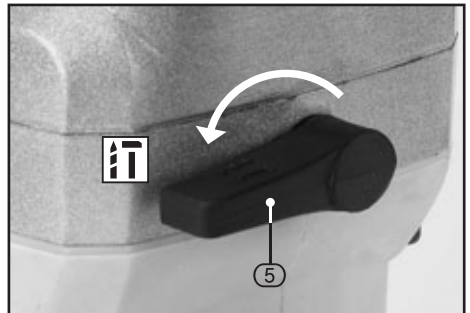

FIG.9

9. BASIC HAMMER DRILL OPERATIONS

9.5 CHISELLING (ROTATIONAL)

– FIGS.10 – 11

- Rotate the drilling/chiselling selector (7) to the rotational chiselling setting.
- Switch the rotary/hammer selector (5) to the drill and hammer setting.

With this combination of settings hammer action will be in operation and also free rotation of the chisel accessory. This operation is best suited for chiselling out masonry/brickwork, concrete breaking applications and demolition work.

9.6 TRIGGER SWITCH – FIG.12

Select the required function.

- Pull trigger (3) to activate the machine.

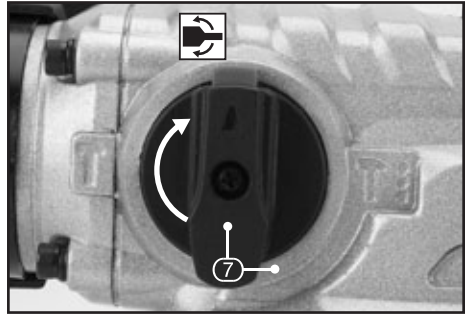

FIG.10

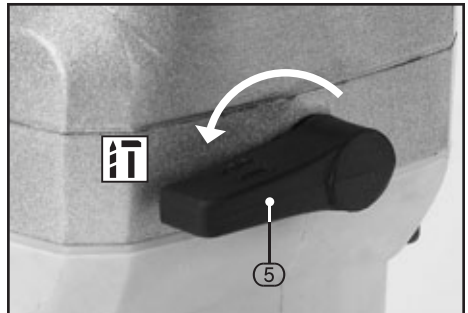

FIG.11

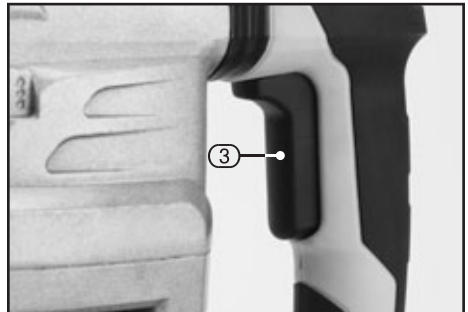

FIG.12

9. BASIC HAMMER DRILL OPERATIONS

9.7 SDS+ SYSTEM – FIGS.13 – 14

The tool holder (1.2) clamps SDS+ drill bits and chisels without the need for a chuck key.

- Pull collar (1.3) back.
- Insert the bit. It may be necessary to rotate the bit to ensure it engages correctly.
- Release the collar to lock the bit in place. Check by pulling the bit to see if it's firmly seated.

Important: Always clean and lightly grease the tool shaft before inserting into the chuck.

Take care that the dust protection cap is not damaged. Allowing dust and debris inside the holder will cause problems in the future.

- To remove a bit, slide the collar (1.3) to the rear and pull out the tool.

Warning! Bit will be hot after use.

9.8 DUST AND SWARF:

A correctly fitted dusk mask, suitable for the activity and in accordance to the relevant standard, must be worn.

For work activities involving exposure to fine wood dust, a mask rated to at least FFP2 should be used.

Swarf produced by metal drilling is extremely sharp. Take precautions when clearing swarf. The burr left on the hole is also sharp and should be removed with a suitable tool.

9.9 DRILLING WOOD, PLASTIC OR METAL

Although technically possible, Draper Tools do not recommend the use of this machine for drilling into wood, metal or plastic. This machine is designed for drilling through brick, concrete and is engineered to do so. This makes it an unwieldy machine to drill wood, metal or plastic and there are tools that are far more capable of doing the job with a greater degree of control.

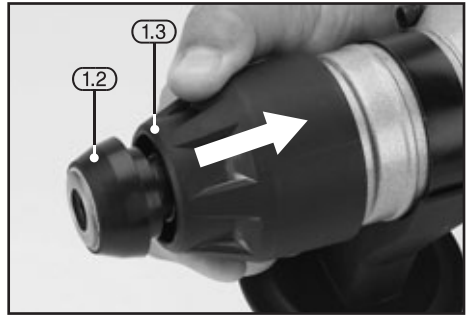

FIG.13

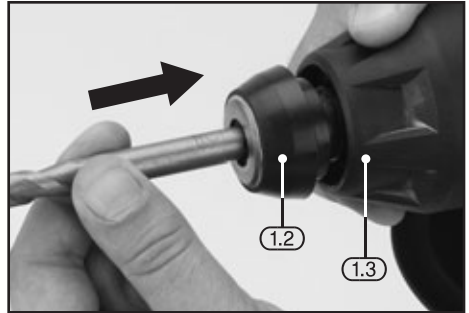

FIG.14

10. MAINTENANCE AND TROUBLESHOOTING

10.1 GEARBOX MAINTENANCE

– FIG.15

Note: Remove the plug from the socket before carrying out adjustment, servicing or maintenance.

- Before each use remove the gearbox access cover (2) to ensure there is sufficient grease.
- Using pin spanner (12) remove the access cover (2) anti-clockwise.
- If required top-up the gearbox (20 grams max.) using a general purpose lithium based grease.
- Lubricating the SDS+ drill bit before inserting into the SDS+ chuck is advisable.

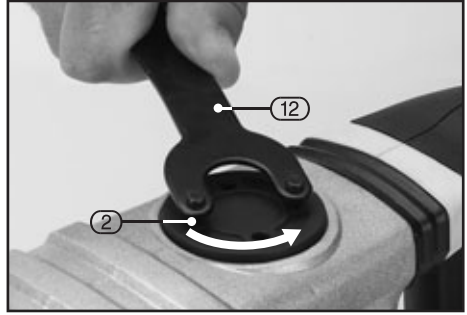

FIG.15

Warning! Assembly must be completed prior to operating the machine.

The hammer drill does not require any special maintenance. Regularly clean/vacuum the ventilation slots. Use only a mild cleaner and a damp cloth to clean the tool.

10.2 TROUBLESHOOTING GUIDE

Note: Remove the plug from the socket before carrying out adjustment, servicing or maintenance.

Problem	Possible Cause	Remedy
Motor does not start.	1. Fuse.	1. Replace/reset 13 amp time delay fuse or circuit breaker.
	2. Brushes worn.	2. Have carbon brushes replaced in motor.
	3. Unsure.	3. Return to an authorised service agent for diagnosis.

11. OPTIONAL ACCESSORIES

11.1 OPTIONAL ACCESSORIES

A full range of accessories are available from Draper Tools.

Please visit our website for details: www.drapertools.com

12. DISPOSAL

12.1 DISPOSAL

- At the end of the machine's working life, or when it can no longer be repaired, ensure that it is disposed of according to national regulations.
- Contact your local authority for details of collection schemes in your area.

In all circumstances:

- Do not dispose of power tools with domestic waste.
- Do not incinerate.
- Do not dispose of WEEE* as unsorted municipal waste.



* *Waste Electrical & Electronic Equipment.*

13. EXPLANATION OF SYMBOLS

13.1 EXPLANATION OF SYMBOLS



Read the instruction manual.



Wear face mask and safety glasses.



Wear ear defenders.



Wear protective gloves.



Do not abandon into the environment.



Keep out of the reach of children.



Warning!



Class II construction
(Double insulated).



WEEE –
Waste Electrical &
Electronic Equipment.

Do not dispose of Waste Electrical & Electronic Equipment in with domestic rubbish.

CONTACTS

Draper Tools Limited, Hursley Road,
Chandler's Ford, Eastleigh, Hampshire. SO53 1YF. U.K.

Helpline: (023) 8049 4344

Sales Desk: (023) 8049 4333

Internet: drapertools.com

E-mail: sales@drapertools.com

General Enquiries: (023) 8026 6355

Service/Warranty Repair Agent:

For aftersales servicing or warranty repairs, please contact the Draper Tools Helpline for details of an agent in your local area.

YOUR DRAPER STOCKIST

TACH0918

©Published by Draper Tools Limited.

No part of this publication may be reproduced, stored in a retrieval system or transmitted in any form or by any means, electronic, mechanical photocopying, recording or otherwise without prior permission in writing from Draper Tools Ltd.