

DRAPER®

INSTRUCTIONS FOR 750W 230V 1100mm Digital Wood Lathe

Stock No.60990 Part No.WTL1100

IMPORTANT: PLEASE READ THESE INSTRUCTIONS CAREFULLY TO ENSURE THE SAFE AND EFFECTIVE USE OF THIS PRODUCT.



CE

DRAPER®

GENERAL INFORMATION

These instructions accompanying the product are the original instructions. This document is part of the product, keep it for the life of the product passing it on to any subsequent holder of the product. Read all these instructions before assembling, operating or maintaining this product.

This manual has been compiled by Draper Tools describing the purpose for which the product has been designed, and contains all the necessary information to ensure its correct and safe use. By following all the general safety instructions contained in this manual, it will ensure both product and operator safety, together with longer life of the product itself.

All photographs and drawings in this manual are supplied by Draper Tools to help illustrate the operation of the product.

Whilst every effort has been made to ensure the accuracy of information contained in this manual, the Draper Tools policy of continuous improvement determines the right to make modifications without prior warning.

1. TITLE PAGE

1.1 INTRODUCTION:

USER MANUAL FOR:

750W 230V 1100mm DIGITAL WOOD LATHE

Stock no. 60990.

Part no. WTL1100.

1.2 REVISIONS:

Date first published January 2015

As our user manuals are continually updated, users should make sure that they use the very latest version.

Downloads are available from: <http://www.drapertools.com/b2c/b2cmanuals.pgm>

DRAPER TOOLS LIMITED

HURSLEY ROAD

CHANDLER'S FORD

EASTLEIGH

HAMPSHIRE

SO53 1YF

UK

WEBSITE: www.drapertools.com

PRODUCT HELPLINE: +44 (0) 23 8049 4344

GENERAL FAX: +44 (0) 23 8026 0784

1.3 UNDERSTANDING THIS MANUALS SAFETY CONTENT:

WARNING! Information that draws attention to the risk of injury or death.

CAUTION! Information that draws attention to the risk of damage to the product or surroundings.

1.4 COPYRIGHT © NOTICE:

Copyright © Draper Tools Limited.

Permission is granted to reproduce this publication for personal & educational use only.

Commercial copying, redistribution, hiring or lending is prohibited.

No part of this publication may be stored in a retrieval system or transmitted in any other form or means without written permission from Draper Tools Limited.

In all cases this copyright notice must remain intact.

2. CONTENTS

2.1 CONTENTS

| | PAGE CONTENT | PAGE |
|----|---|-------------|
| 1 | TITLE PAGE | |
| | 1.1 INTRODUCTION | 2 |
| | 1.2 REVISION HISTORY | 2 |
| | 1.3 UNDERSTANDING THIS MANUAL | 2 |
| | 1.4 COPYRIGHT NOTICE | 2 |
| 2 | CONTENTS | |
| | 2.1 CONTENTS | 3 |
| 3 | GUARANTEE | |
| | 3.1 GUARANTEE | 4 |
| 4 | INTRODUCTION | |
| | 4.1 SCOPE | 5 |
| | 4.2 SPECIFICATION | 5 |
| | 4.3 HANDLING & STORAGE | 5 |
| 5 | HEALTH & SAFETY INFORMATION | |
| | 5.1 GENERAL SAFETY INSTRUCTIONS FOR POWER TOOL USE | 6-8 |
| | 5.2 CONNECTION TO THE POWER SUPPLY | 8 |
| 6 | TECHNICAL DESCRIPTION | |
| | 6.1 IDENTIFICATION | 10B |
| 7 | UNPACKING & CHECKING | |
| | 7.1 PACKAGING | 10A |
| | 7.2 WHAT'S IN THE BOX? | 10A |
| 8 | PREPARING THE WOOD LATHE | |
| | 8.1 WOOD LATHE STAND | 11 |
| | 8.2 MOUNTING THE WOOD LATHE TO THE STAND | 11 |
| | 8.3 NO-VOLT ON/OFF SWITCH | 11 |
| | 8.4 DRIVE SPUR AND LIVE CENTRE | 11 |
| | 8.5 REMOVAL | 12 |
| 9 | SETTING THE WOOD LATHE | |
| | 9.1 NO-VOLT ON/OFF SWITCH | 13 |
| | 9.2 CHANGING SPEED | 13 |
| | 9.3 ROTATING THE HEADSTOCK | 13 |
| | 9.4 SLIDING THE HEADSTOCK | 13 |
| | 9.5 MOVING THE TAILSTOCK | 14 |
| | 9.6 ADJUSTING THE TOOL REST | 14 |
| | 9.7 CHANGING THE BELT | 14 |
| 10 | BASIC WOOD TURNING | |
| | 10.1 SPINDLE TURNING | 15 |
| | 10.2 USING WOODWORKING CHISELS | 16 |
| | 10.3 THE THEORY OF TURNING | 16 |
| | 10.4 KNOWING WHEN TO CUT AND WHEN TO SCAPE | 17 |
| | 10.5 POSITIONING THE TOOL REST FOR CIRCUMFERENCE TURNING | 18-19 |
| | 10.6 POSITIONING THE TOOL REST FOR CIRCUMFERENCE SCRAPING | 19 |
| | 10.7 POSITIONING CHISEL AND TOOL REST FOR DIAMETER SCRAPING | 20 |
| | 10.8 USING THE GOUGE CHISEL | 20 |
| | 10.9 USING A SKEW CHISEL | 21 |
| | 10.10 USING A PARTING CHISEL | 22 |
| | 10.11 USING SCRAPING CHISELS | 22 |
| 11 | TROUBLESHOOTING | 23 |
| 12 | MAINTENANCE | |
| | 12.1 MAINTENANCE | 24 |
| 13 | OPTIONAL ACCESSORIES | |
| | 13.1 WOOD LATHE ACCESSORIES | 25 |
| 14 | EXPLANATION OF SYMBOLS | |
| | 14.1 EXPLANATION OF SYMBOLS | 26 |
| 15 | DISPOSAL | |
| | 15.1 DISPOSAL | 27 |
| | DECLARATION OF CONFORMITY | ENCLOSED |

3. GUARANTEE

3.1 GUARANTEE

Draper tools have been carefully tested and inspected before shipment and are guaranteed to be free from defective materials and workmanship.

Should the tool develop a fault, please return the complete tool to your nearest distributor or contact Draper Tools Limited, Chandler's Ford, Eastleigh, Hampshire, SO53 1YF. England. Telephone Sales Desk: (023) 8049 4333 or Product Helpline (023) 8049 4344.

A proof of purchase must be provided with the tool.

If upon inspection it is found that the fault occurring is due to defective materials or workmanship, repairs will be carried out free of charge. This guarantee period covering parts/labour is 12 months from the date of purchase except where tools are hired out when the guarantee period is ninety days from the date of purchase. The guarantee is extended to 24 months for parts only. This guarantee does not apply to normal wear and tear, nor does it cover any damage caused by misuse, careless or unsafe handling, alterations, accidents, or repairs attempted or made by any personnel other than the authorised Draper warranty repair agent.

Note: If the tool is found not to be within the terms of warranty, repairs and carriage charges will be quoted and made accordingly.

This guarantee applies in lieu of any other guarantee expressed or implied and variations of its terms are not authorised.

Your Draper guarantee is not effective unless you can produce upon request a dated receipt or invoice to verify your proof of purchase within the guarantee period.

Please note that this guarantee is an additional benefit and does not affect your statutory rights.

Draper Tools Limited.

4. INTRODUCTION

4.1 SCOPE

This machine is designed for the turning of wood on its axis to perform operations such as cutting, knurling and sanding. Any other application is considered mis-use.

4.2 SPECIFICATION

| | |
|----------------------------|-----------------------|
| Stock no | 60990 |
| Part no | WTL1100 |
| Rated voltage | 230V/50Hz |
| Rated input | 750W |
| Woodturning capacity | |
| Diameter | 360mm |
| Length..... | 1100mm |
| Spindle speed | 500 - 2000rpm |
| Spindle thread | $\frac{3}{4}$ x 16TPI |
| Spindle taper | MT1 |
| Sound pressure level | 73dB(A) |
| Sound power level | 86dB(A) |
| Vibration level | N/A |
| Weight | 92kg |

4.3 HANDLING & STORAGE

The environment will have a negative result on its operation if you are not careful. If the air is damp, components will rust. If the machine is unprotected from dust and debris; components will become clogged: And if not cleaned and maintained correctly or regularly the machine will not perform at its best.

5. HEALTH & SAFETY INFORMATION

5.1 GENERAL SAFETY INSTRUCTIONS FOR POWER TOOL USE

When using any type of power tool there are steps that should be taken to make sure that you, as the user, remain safe.

Common sense and a respect for the tool will help reduce the risk of injury.

Read the instruction manual fully. Do not attempt any operation until you have read and understood this manual.

Most important you must know how to safely start and stop this machine, especially in an emergency.

Keep the work area tidy and clean. Attempting to clear clutter from around the machine during use will reduce your concentration. Mess on the floor creates a trip hazard. Any liquid spilt on the floor could result in you slipping.

Find a suitable location. If the machine is bench mounted; the location should provide good natural light or artificial lighting as a replacement. Avoid damp and dust locations as it will have a negative effect on the machine's performance.

If the machine is portable; do not expose the tool to rain. In all cases do not operate power tools near any flammable materials.

Beware of electric shock. Avoid contact with earthed surfaces; because they can conduct electricity if there is an electrical fault with the power tool. Always protect the power cable and route it away from danger.

Keep bystanders away. Children, onlookers and passers by must be restricted from entering the work area for their own protection. The barrier must extend a suitable distance from the tool user.

Unplug and house all power tools that are not in use. A power tool should never be left unattended while connected to the power supply. They must be housed in a suitable location, away locked up and from children.

Do not overload or misuse the tool. All tools are designed for a purpose and are limited to what they are capable of doing. Do not attempt to use a power tool (or adapt it in any way) for an application it is not designed for. Select a tool appropriate for the size of the job. Overloading a tool will result in tool failure and user injury: This covers the use of accessories.

Dress properly. Loose clothing, long hair and jewellery are all dangerous because they can become entangled in moving machinery: This can also result in parts of body being pulled into the machine.

Clothing should be close fitted, with any long hair tied back and jewellery and neck ties removed. Footwear must be fully enclosed and have a nonslip sole.

5. HEALTH & SAFETY INFORMATION

Wear personal protective equipment (PPE). Dust, noise, vibration and swarf can all be dangerous if not suitably protected against. If the work involving the power tool creates dust or fumes; wear a dust mask. Vibration to the hand, caused by operating some tools for longer periods must be protected against. Wear vibration reducing gloves and allow long breaks between uses. Protect against dust and swarf by wearing approved safety goggles or a face shield. These are some of the more common hazards and preventions; however, always find out what hazards are associated with the machine/work process and wear the most suitable protective equipment available.

Do not breathe contaminated air. If the work creates dust or fumes; connect the machine (if possible) to an extraction system either locally or remotely. Working outdoors can also help if possible.

Move the machine as instructed. If the machine is hand held, do not carry it by the power supply cable. If the product is heavy; employ a second or third person to help move it safely or use a mechanical device. Always refer to the instructions for the correct method.

Do not overreach. Extending your body too far can result in a loss of balance and you falling. This could be from a height or onto a machine and will result in injury.

Maintain your tools correctly. A well maintained tool will do the job safely. Replace any damaged or missing parts immediately with original parts from the manufacturer. As applicable; keep blades sharp; moving parts clean, oiled or greased; handles clean; and emergency devices working.

Wait for the machine to stop. Unless the machine is fitted with a safety brake; some parts may continue to move due to momentum. Wait for all parts to stop; then unplug it from the power supply before making any adjustments, carrying out maintenance operations or just finishing using the tool.

Remove and check setting tools. Some machinery requires the use of additional tools or keys to set, load or adjust the power tool. Before starting the power tool always check to make certain they have been removed and are safely away from the machine.

Prevent unintentional starting. Before plugging any machine in to the power supply, make sure the switch is in the OFF position. If the machine is portable; do not hold the machine near the switch and take care when putting the machine down; that nothing can operate the switch.

Carefully select an extension lead. Some machines are not suitable for use with extension leads. If the tool is designed for use outdoors; use an extension lead also suitable for that environment. When using an extended lead, select one capable of handling the current (amps) drawn by the machine in use. Fully extend the lead regardless of the distance between the power supply and the tool. Excess current (amps) and a coiled extension lead will both cause the cable to heat up and can result in fire.

Concentrate and stay alert. Distractions are likely to cause an accident. Never operate a power tool if you are under the influence of drugs (prescription or otherwise), including alcohol or if you are feeling tired. Being disorientated will result in an accident.

5. HEALTH & SAFETY INFORMATION

Have this tool repaired by a qualified person. This tool is designed to conform to the relevant international and local standards and as such should be maintained and repaired by someone qualified; using only original parts supplied by the manufacturer: This will ensure the tool remains safe to use.

Read and understand the instruction manual before operation.

- 1) Always wear eye protection which complies to a recognised standard.
- 2) Wear a mask or respirator when dust is generated.
- 3) Keep hands clear of moving parts.
- 4) Keep turning chisels sharp.
- 5) Keep pulley cover guards in place when working.
- 6) Never reach behind or beneath the workpiece.
- 7) Unplug from power supply before adjusting or servicing.
- 8) To avoid electric shock do not use in damp conditions or expose to rain.
- 9) For indoor use only.
- 10) Secure the work piece correctly/safely.

5.2 CONNECTION TO THE POWER SUPPLY

Make sure the power supply information on the machine's rating plate are compatible with the power supply you intend to connect it to.

If a replacement plug is to be fitted this must be carried out by a qualified electrician.

The damaged or incomplete plug, when cut from the cable shall be disabled to prevent connection to a live electrical outlet.

This appliance is Class I[†] and is designed for connection to a power supply matching that detailed on the rating label and compatible with the plug fitted.

If an extension lead is required, use an approved and compatible lead rated for this appliance. Follow all the instruction supplied with the extension lead.

[†]Earthed  : This product requires an earth connection to protect against electric shock from accessible conductive parts in the event of a failure of the basic insulation.

6. TECHNICAL DESCRIPTION

6.1 IDENTIFICATION

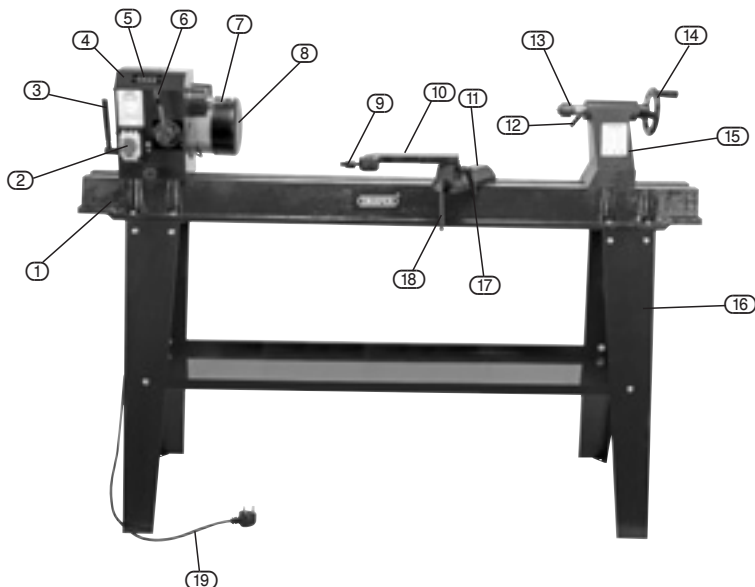

- | | | | |
|---|------------------------|---|----------------------------|
| ① | Bed. | ⑪ | Tool rest bolt. |
| ② | ON/OFF switch. | ⑫ | Locking tailstock bolt. |
| ③ | Locking lever. | ⑬ | Live centre. |
| ④ | Headstock. | ⑭ | Tail spur adjustment knob. |
| ⑤ | Digital speed display. | ⑮ | Tailstock. |
| ⑥ | Speed change lever. | ⑯ | Stand. |
| ⑦ | Drive spur. | ⑰ | Tool rest locking bolt. |
| ⑧ | Motor. | ⑱ | Locking handle. |
| ⑨ | Tool rest. | | |
| ⑩ | Tool rest extension. | | |

7. UNPACKING & CHECKING

7.1 PACKAGING

Carefully remove the product from the packaging and examine it for any sign of damage that may have happened during shipping. Lay the contents out and check them against the parts shown below. If any part is damaged or missing; please contact the Draper Helpline (the telephone number appears on the Title page) and do not attempt to use the product.

The packaging material should be retained at least during the guarantee period: in case the machine needs to be returned for repair.

Warning! Some of the packaging materials used may be harmful to children. Do not leave any of these materials in the reach of children.

If any of the packaging is to be thrown away, make sure they are disposed of correctly; according to local regulations.

7.2 WHAT'S IN THE BOX?

As well as the lathe; there are several parts not fitted or attached to it.

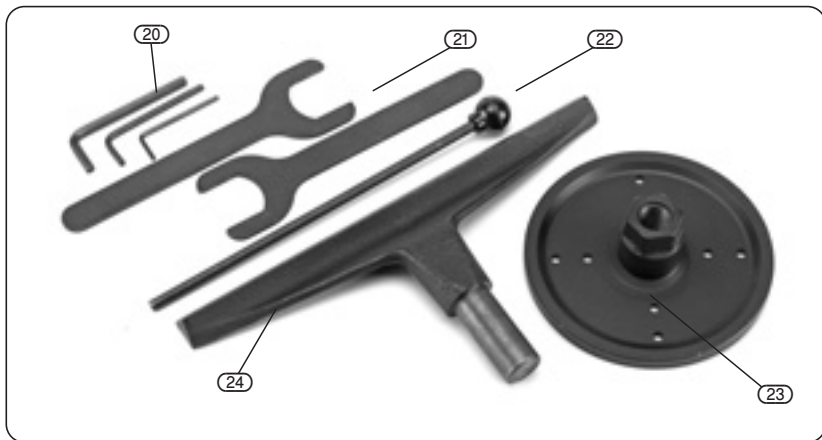

- (20) Hex. keys.
- (21) Spanners.
- (22) Push rod.
- (23) Face plate.
- (24) Tool rest.

8. PREPARING THE WOOD LATHE

8.1 WOOD LATHE STAND - FIG. 1

Using the nuts and bolts supplied, fix together both the top plates (15.1) with the four legs (15.2). Bolt on the shelf or four supports (15.3) and tighten all the fixings.

NOTE: The Wood Lathe stand should always be fastened down securely to the floor using four suitable fixings (not supplied).

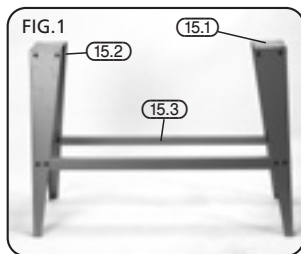

8.2 MOUNTING THE WOOD LATHE TO THE STAND - FIG. 2

Lift the lathe onto the stands top plates (seek assistance as this is very heavy). Align the holes in the bed with the stand and bolt in place using the 8 fixings supplied.

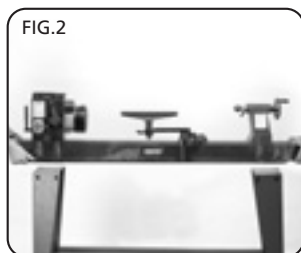

8.3 NO-VOLT ON/OFF SWITCH - FIG. 3

The no-volt switch is recommended to be fixed into place on the leg of the stand using the two bolts (2.1) which are longer, coming through the rear of the switch box.

NOTE: Make sure the cable from the switch to the motor will allow the rotation of the headstock. Ensure the lead never passes between bed and workpiece.

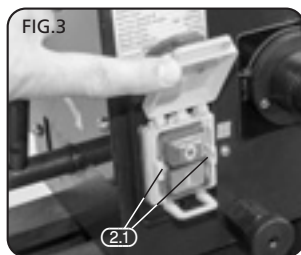

8.4 DRIVE SPUR AND LIVE CENTRE - FIG. 4

Locate the drive spur (with prongs) and the live centre (with bearing) from the packaging. Insert the live centre (13) into the barrel of the tail stock and with a piece of scrap timber and a hammer, tap the spur in until secure. Carry out the same procedure for the drive spur into the headstock spindle.

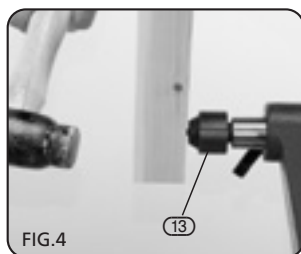

8. PREPARING THE WOOD LATHE

8.5 REMOVAL - FIGS. 5 - 6

When the need arises to remove the spurs, use the ejection pin (22) to push out the live centre from the tailstock by inserting it down the centre of the tailstock handwheel hole (15.1).

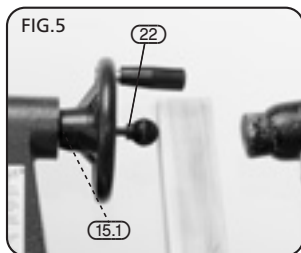

The drive spur is removed using the ejection pin (22) and the spindle holding wrench (21). Using the wrench to hold the spindle on the flats, insert the ejection pin into the hole in the side of the thread protection cap (4.1). Undo the cap which will force the spur out of the spindle.

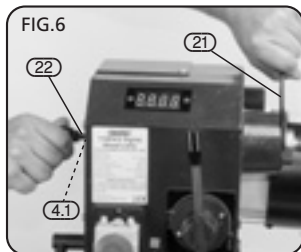

9. SETTING THE WOOD LATHE

9.1 NO-VOLT ON/OFF SWITCH - FIG. 7

NOTE: The WTL95 is fitted with an additional emergency shut off cover.

In the event of an emergency, closing the cover firmly will cause the stop button to be triggered, thus stopping the machine. To re-open the cover, the red button requires sliding which in turn will release the cover and stop button.

In the event of a power failure the machine will have to be manually restarted.

To switch the machine on, lift up the sprung cover and push the button marked ①.

To switch the machine off, lift up the sprung cover and push the button marked ①.

To switch the machine off in an emergency strike the cover ② firmly which will trigger the (0) button.

9.2 CHANGING SPEED - FIG. 8

The machine has to be running for the speed change to move.

With the machine running, pull the lever ⑥ away from the headstock then move it around to the desired speed. The handle indicates the speed. For example, Fig.10 is set on speed 1. The Lathe should be in speed 1 (the slowest) before turning off to aid ease of start up.

9.3 ROTATING THE HEADSTOCK - FIG. 9

The headstock can be rotated 45, 90, 135 and 180°. Loosen handle ③ and pull the release pin ④.2. When pin ④.2 is pulled out, the head can be rotated. Once the head is rotated to the desired angle, release the pin and it will lock into place. Once setup, retighten handle ③.

NOTE: This operation may be necessary for turning bowls, etc.

9.4 SLIDING THE HEADSTOCK - FIG. 10

By loosening handle ③ you can slide the headstock along the bed. Once set in position, lock in place using handle ③.

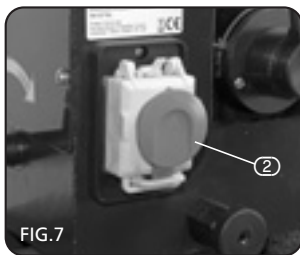

FIG.7

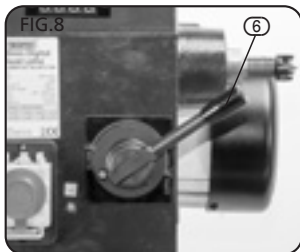

FIG.8

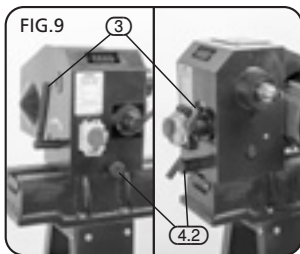

FIG.9

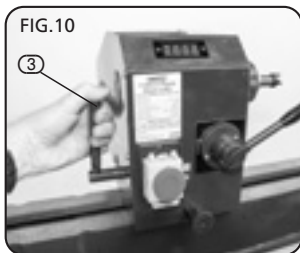
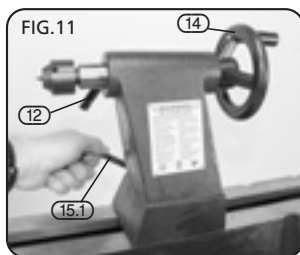

FIG.10

9. SETTING THE WOOD LATHE

9.5 MOVING THE TAILSTOCK - FIG. 11

To slide the tailstock along the bed, loosen lever (13.1). Once set in position, lock in place by tightening lever (15.1). To move live spur in and out with the barrel, loosen locking lever (12) and rotate wheel (13). Once the position is set, lock in place using lever (12).



9.6 ADJUSTING THE TOOL REST - FIG. 12

To move the tool rest along the bed, slide it back and forth or rotate loosen handle (18). To angle or change the height, of the tool rest (24), loosen handle (17). This set up with the tool rest will provide for most of your needs. However, should it be required for bowl turning etc, there is an extension (10) provided. This fits by loosening handle (17). Remove the tool rest and replace with the extension. Loosen handle (9) on the extension and slide in tool rest. When fully adjusted, make sure all of the locking handles are secured.

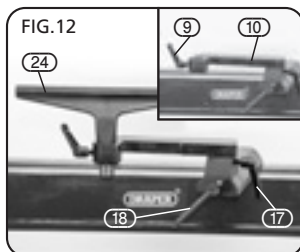

9.7 CHANGING THE BELT - FIG. 13

Make sure the lathe is in speed position 1. Switch off power supply and remove the plug. Remove the pulley cover. Insert a disc (the size of a two pence piece) between the two halves of the motor pulley and between the belt runs. Slowly rotate the drive spindle back and forth by hand while turning the speed lever slowly to a higher speed. When maximum speed has been reached on the lever, the belt can be removed easily. Fit a new belt over both pulleys. Slowly rotate the drive spindle back and forth by hand while turning the speed lever slowly to the slowest speed. When speed 1 is reached, the disc may be removed and pulley cover replaced.

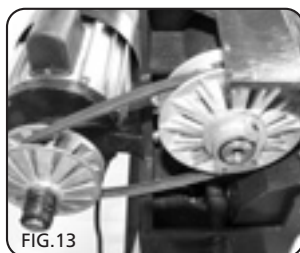

10. BASIC WOOD TURNING

The following pages of this manual explain and illustrate the correct use of the turning tools, the tool rest and other information to help you.

10.1 SPINDLE TURNING - FIGS. 15 - 18

Select a piece of wood 50x50x300mm (approx.) Draw diagonal lines on each end the piece of wood to locate the centres (Fig.7).

In both ends of the piece of wood drill a 1.5mm hole, 7mm deep into the centre. Now secure the workpiece in a soft jaw vice. Put the point of the drive spur into the drilled hole and tap the spur in securely (Fig.8).

Now remove the spur and check the prongs have left an imprint.

Ensure that both the drive spur and live centre are clean and insert them into the lathe (see page 7). Place the workpiece between the centres and close up the tailstock (Fig.9) making sure the marked end goes the tailstock end.

Select the required tool rest position approx 3mm away from the corners of the wood and 3mm above the centre line (Fig.10) and lock the tool rest into position. Now select the appropriate speed (see Page 8), rotate the workpiece to check the corners do not foul the tool rest.

FIG.15



FIG.16

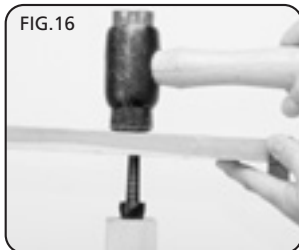
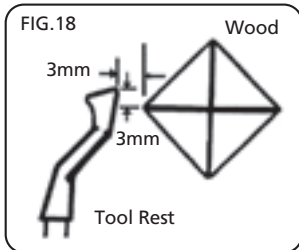

FIG.17



FIG.18



10. BASIC WOOD TURNING

10.2 USING WOODWORKING CHISELS - FIG. 19

Professional woodturning chisels have handles approximately 250mm long. This provides the operator with good grip and leverage. A sharp chisel will be much easier to work with and will give the job a cleaner finish. Fig.11 shows the six most commonly used types of turning chisel.

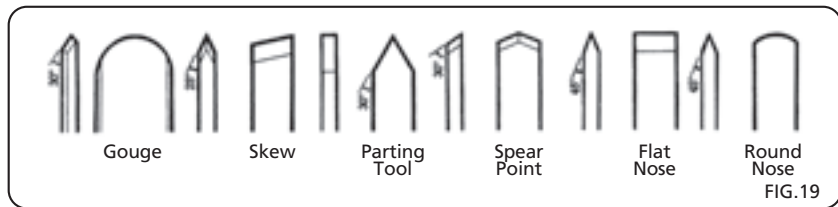

10.3 THE THEORY OF TURNING - FIGS. 20 - 21

There are two types of turning chisel. These are:

1. Those intended primarily for cutting,
2. Those used only for scraping.

The cutting chisels are the gouge, skew and parting type. These are sharpened to a razor edge by honing on both sides.

The scraping chisels are the flat nose, round nose and spear point. These are not honed on the flat sides - the wire edges produced by scraping are left on to aid in the scraping process (Fig.20). Shows the two types of chisel.

CUTTING AND SCRAPING:

To make a cut, the chisel should be held so that the sharp edge actually digs into the revolving workpiece, shavings should now peel off. To scrape, the chisel should be held at a right angle to the surface of the workpiece, fine pieces of wood will be produced when scraping instead of shavings (Fig.21).

Many operations require the cutting chisel to be used for scraping but scraping chisels are very rarely used for cutting. Scraping will blunt/dull a chisel much faster especially when using razor sharp cutting chisels.

Cutting is much faster than scraping and produces a much smoother finish. Cutting is more difficult than scraping, but scraping is more precise and easier to control.

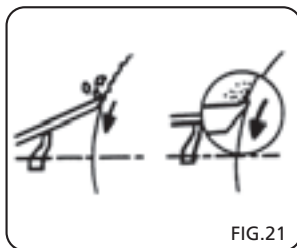
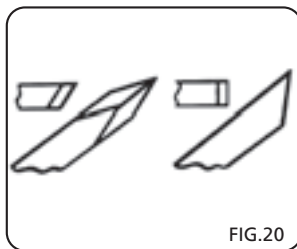

10. BASIC WOOD TURNING

10.4 KNOWING WHEN TO CUT AND WHEN TO SCRAPE - FIG. 22

There are two different approaches to the work when turning. The first is towards a circumference of the workpiece (eg. When turning down the outer surface of a cylinder or the inner wall of a hollow round box). Using this method, the surface being turned travels under the edge of the chisel like an endless belt. The second approach is towards the diameter of the workpiece (as when turning the face when faceplate turning, or the side of a large shoulder when spindle turning) using this method the surface being turned rotates like a disc under the chisel edge. Some jobs will require both methods being used.

Either a cutting or scraping action may be used when the method used is towards the circumference – the shaving will come off like the peel from a potato.

Only scraping can be used when the method used is towards the diameter. The reason for this is obvious when you consider that faceplate turning nearly always requires the removal of wood across the grain. Wood does not peel easily when turning across the grain and any attempt made to use cutting methods will probably result in damage to the workpiece and the chisel being thrown by the workpiece.

It therefore follows that a cutting action is used for general spindle turning operations, while the majority of faceplate turning is carried out by the scraping method. When both methods are to be used, you will have to judge by the feel of the workpiece when to stop cutting and start scraping. NEVER try to cut when it becomes difficult to hold the chisel against the wood grain.

FIG.22

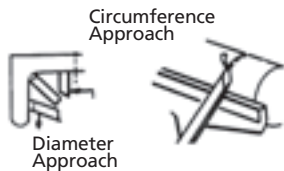

10. BASIC WOOD TURNING

10.5 POSITIONING THE TOOL REST FOR CIRCUMFERENCE TURNING - FIGS 23 - 26

When turning, the object is to pierce the outer surface of the wood to a desired depth, then to hold the chisel steady with the bevel edge parallel to the work circumference, so that the chisel will peel off a shaving at this desired depth. The only sure method of holding the chisel steady is to rest the bevel against the workpiece, the tool rest will act as a fulcrum to support the chisel against the downward force of the revolving workpiece (Fig.23).

If the tool rest is positioned too low, so that the chisel bevel is held out from the workpiece, (Fig.24) the cutting edge of the chisel will continue to dig deeper into the workpiece until the "bite" becomes so deep that you have difficulty holding the chisel, then the chisel will begin to bounce or chatter against the workpiece.

If the tool rest is positioned too low, the chisel will be held extremely high to position the bevel of the chisel against the workpiece (Fig.25) then the tool rest will lose its value as a fulcrum and the downward force of the revolving workpiece will kick the chisel back and possibly out of your hands.

If the tool rest is positioned too high and the chisel is correctly positioned for cutting it will strike near the top of the workpiece where the direction of the force exerted by the workpiece is almost horizontal and will again result in kickback (Fig.26).

FIG.23

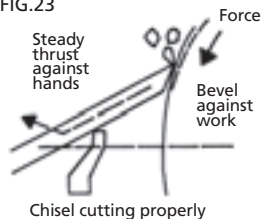

FIG.24

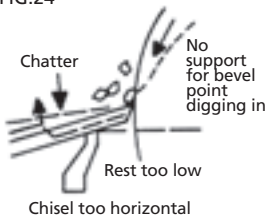

FIG.25

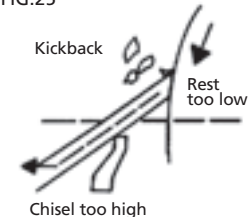
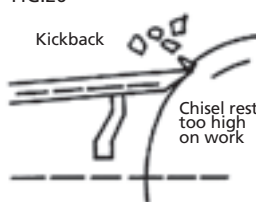

FIG.26



10. BASIC WOOD TURNING

If the tool rest is positioned too far away from the workpiece as shown in (Fig.27), the chisel, when correctly held will again be too high on the workpiece. You will also find that you have less leverage on your side of the tool rest and it will be very difficult to hold the chisel.

With a large diameter workpiece, the tool rest can be above the workpiece centre line and further out from the surface of the workpiece than normal (Fig.28).

With a small diameter workpiece, the tool rest should be closer to the surface workpiece than normal. As the workpiece gets smaller the rest should be repositioned (Fig.29).

10.6 POSITIONING THE TOOL REST FOR CIRCUMFERENCE SCRAPING - FIGS. 29 - 32

When scraping, the position of the tool is not as critical as it is for cutting operations. The chisel is normally held horizontally, although it can be held at an angle to reach difficult places. The wire edge of the chisel does the scraping. Fig.30 and 32 show the result of a chisel being too low or too high. Fig.31 shows the chisel positioned correctly on the tool rest.

FIG.27

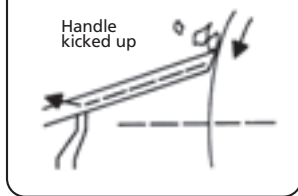

FIG.28

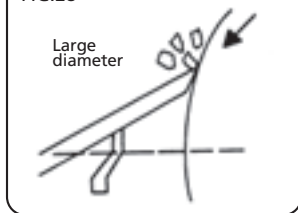

FIG.29

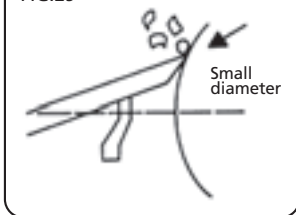

FIG.30

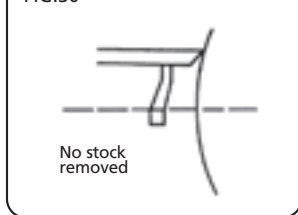

FIG.31

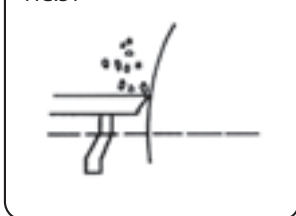
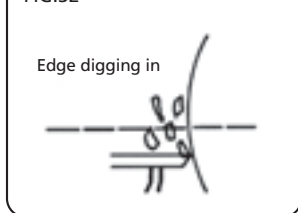

FIG.32



10. BASIC WOOD TURNING

10.7 POSITIONING CHISEL AND TOOL REST FOR DIAMETER SCRAPING - FIGS. 33 - 34

When diameter scraping, the area to the right of the centre is moving upward (Fig.33). If the chisel is placed in this area it will simply be carried up and off the tool rest, possibly out of your hands. So all diameter approach operations **MUST** be done at the left of the centre.

Three different chisel contact points are shown (Fig.34). Note that when the chisel is positioned above or below the workpiece centre, the work surface sweeps past the chisel edge at an angle and will tend to carry the chisel in one direction along the tool rest.

Only when the chisel contacts the workpiece centre line does the workpiece pass squarely under the edge of the chisel. This then is the position in which it is easiest to hold the chisel steady. To obtain the position place the rest approximately 3mm below the centre.

FIG.33

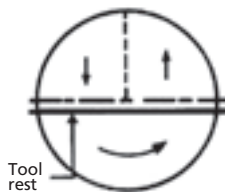
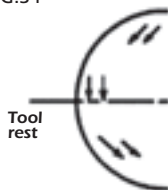

FIG.34



10.8 USING THE GOUGE CHISEL - FIGS. 35 - 36

Three gouges 6, 12, 18mm sizes are usually sufficient for home workshop turning, but other sizes are available (refer to Draper Catalogue). A gouge chisel is normally used for rough circumference turning or turning raw stock down to a cylinder of workable size. It is best used for rapid removal of the workpiece, but will not produce such a smooth finish, but with practice it can be used for cutting coves, for shaping long cuts and is also useful for scraping.

When used for cutting, the gouge is always held with the convex side down and should be rolled approximately 30° to 45° in the direction in which it is being advanced along the rest, the cutting edge would be a little in advance of the handle, Figs. 35 & 36.

FIG.35



FIG.36

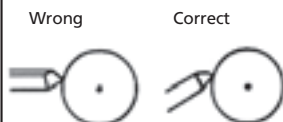

10. BASIC WOOD TURNING

10.9 USING A SKEW CHISEL - FIGS. 37 - 41

Two skew chisels 12, 25mm are all that are required for general use although other sizes are available (refer to Draper Catalogue). This chisel is used mostly for making finished cuts, to cut vees and beads and square shoulders. When correctly used, it will produce the best finish that can be obtained with a chisel. It should not be used for scraping as this will quickly dull it.

For finish cutting, the skew should be held with the cutting edge considerably in advance of the handle and should be bevel against the work. Good practice is to place the skew well over the workpiece and pull it back until the edge begins to cut; then swing the handle into position to advance the cut. Both the toe and the heel of the skew can be used for making light cuts; but do not penetrate the wood too deeply without cutting clearances as you may burn the tip of the tool.

FIG.37

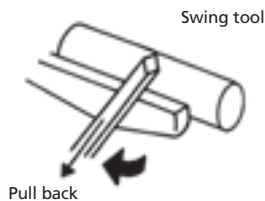

FIG.38

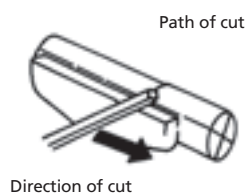

FIG.39

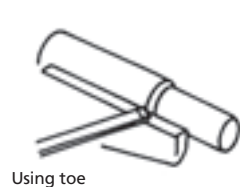

FIG.40

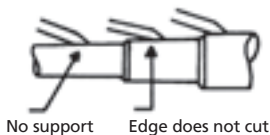
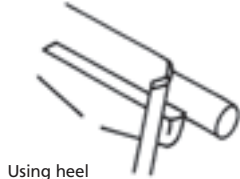

FIG.41



10. BASIC WOOD TURNING

10.10 USING A PARTING CHISEL - FIGS. 42 - 43

A parting chisel has one primary purpose - to cut straight into the workpiece as deep as desired, or all the way through the workpiece to make a cut off. This is a very narrow chisel, approximately 3mm wide and is shaped to cut its own clearance, so the cutting edge will not burn. But when used as a scraper, it should be backed off at regular intervals to prevent overheating.

FIG.42



FIG.43

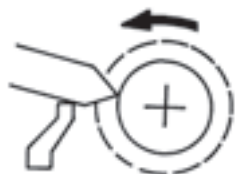

10.11 USING SCRAPING CHISELS - FIGS. 44 - 46

Finally, three more types of chisel should complete the list of chisels for the average craftsman, these are 12mm spear point, 12mm round nose and 26mm flat nose. Each of these chisels may be purchased in various sizes, (refer to the Draper Catalogue) for special jobs. All of these are very useful for diameter scraping operations and for circumference scraping when cutting methods cannot be employed.

The spear point chisel is used for fine scraping and delicate operations such as the forming of beads, parallel grooves and shallow vees. Edges and bowl contours can be rounded with the round nose chisel. Any flat surface can be scraped with the flat nose chisel.

FIG.44



FIG.45



FIG.46

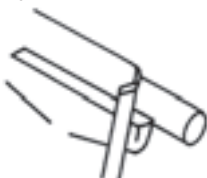

11. TROUBLESHOOTING

NOTE: Repairs should only be carried out by a qualified person.

| PROBLEM | PROBABLE CAUSE | SUGGESTED REMEDY |
|------------------------------|--|--|
| Motor will not run. | Fuse blown. Defective on/off switch. Defective switch cord. Burned out motor. | Remove plug from power supply and replace fuse. Replace defective parts before using lathe again. Any attempt to repair this motor may cause a hazard unless the repair is done by a qualified service technician. |
| Headstock loose on bed. | Locking handle not tight. | Tighten locking handle. |
| Wood burns at tailstock end. | Live centre too tight or not lubricated. | Back of tailstock barrel and lubricate live centre. See Basic Lathe Operation "Spindle Turning" |

12. MAINTENANCE

12.1 MAINTENANCE

WARNING! Disconnect the lathe from the power source before servicing, changing accessories, or performing any other maintenance.

Check the gearbox oil level on a monthly basis. This should be done with the bow raised to its highest position. Observe the oil level in the sight glass on the side of the gearbox. If required, top up the oil by removing the filler bolt from the upper part of the gearbox just below the motor. Change the oil every 6 months. The drain plug is at the bottom of the gearbox. Drain the gearbox with the bow in its highest position.

Keep all surfaces clean and free from rust, slag, chips and coolant build-up.

Do not use compressed air to clean lathe. Compressed air may force chips into the guide bearings and other critical areas of the saw.

Use a small paint brush or parts cleaning brush to remove metal particles.

Wipe saw down with a clean dry cloth and oil all unpainted surfaces with light machine oil.

Keep blade guides clean and free from metal chips.

Check guide bearings frequently to make sure they are properly adjusted and running freely.

BLADE CLEANING BRUSH. It is important that the blade cleaning brush be properly adjusted and kept in good working order. The brush is mounted behind the fixed blade guide.

Blade life will be shortened severely if the brush is allowed to go out of adjustment, becomes worn or damaged. Replace the brush if it becomes worn or damaged.

Clean out the coolant tank at least twice a year.

WARNING! DO NOT attempt to adjust the blade brush with the machine running. Adjust only when the machine is disconnected from the power source.

13. OPTIONAL ACCESSORIES

13.1 WOOD LATHE ACCESSORIES

The following accessories are available from your local Draper Stockist.

| Stock No. | Part No. | Description |
|------------------|-----------------|--------------------------------|
| 29422 | AWL1 | Tailstock Chuck and Arbour Set |
| 29424 | AWL3 | Screw Chuck |
| 29429 | AWL8 | Right Hand Thread Face Plate |
| 37168 | AWL40 | Combination Chuck |
| 33831 | F58 | Face Shield |
| 58697 | AWL44 | HSS Wood Turning Chisels |

For a comprehensive range of wood lathe accessories refer to the Draper Catalogue

14. EXPLANATION OF SYMBOLS

14.1 EXPLANATION OF SYMBOLS



Warning!
Do not wear loose clothing.



Warning!
Read the instruction manual



Warning!
Wear gloves.



Warning!
Keep hands away for blade.



Warning!
Wear ear defenders.



Warning!
Wear goggles.



WEEE
Do not dispose of Waste Electrical
& Electronic Equipment in with
domestic rubbish



Warning!
Wear dust mask.



Warning! Disable the machine
before attempting to maintain it.

15. DISPOSAL

15.1 DISPOSAL

- At the end of the machine's working life, or when it can no longer be repaired, ensure that it is disposed of according to national regulations.
- Contact your local authority for details of collection schemes in your area.

In all circumstances:

- Do not dispose of power tools with domestic waste.
- Do not incinerate.
- Do not abandon in the environment.
- Do not dispose of WEEE* as unsorted municipal waste.



* Waste Electrical & Electronic Equipment.

- **DRAPER TOOLS LIMITED,**
Hursley Road, Chandler's Ford,
Eastleigh, Hampshire. SO53 1YF. U.K.
- **Helpline:** (023) 8049 4344
- **Sales Desk:** (023) 8049 4333
- **Internet:** www.drapertools.com
- **E-mail:** sales@drapertools.com
- **Sales Fax:** (023) 8049 4209
- **General Enquiries:** (023) 8026 6355
- **Service/Warranty Repair Agent**
For aftersales servicing or warranty repairs, please contact the Draper Tools Helpline for details of an agent in your local area.

YOUR DRAPER STOCKIST