



INSTRUCTIONS FOR 100A 230V Gasless MIG Welder

Stock No.63669 Part No.MIG100

IMPORTANT: PLEASE READ THESE INSTRUCTIONS CAREFULLY TO ENSURE THE SAFE AND EFFECTIVE USE OF THIS PRODUCT.



CE

DRAPER®

GENERAL INFORMATION

These instructions accompanying the product are the original instructions. This document is part of the product, keep it for the life of the product passing it on to any subsequent holder of the product. Read all these instructions before assembling, operating or maintaining this product.

This manual has been compiled by Draper Tools describing the purpose for which the product has been designed, and contains all the necessary information to ensure its correct and safe use. By following all the general safety instructions contained in this manual, it will ensure both product and operator safety, together with longer life of the product itself.

All photographs and drawings in this manual are supplied by Draper Tools to help illustrate the operation of the product.

Whilst every effort has been made to ensure the accuracy of information contained in this manual, the Draper Tools policy of continuous improvement determines the right to make modifications without prior warning.

1. TITLE PAGE

1.1 INTRODUCTION:

USER MANUAL FOR:

100A 230V GASLESS MIG WELDER

Stock no. 63669

Part no. MIG100

1.2 REVISIONS:

Date first published November 2016.

As our user manuals are continually updated, users should make sure that they use the very latest version.

Downloads are available from: <http://www.drapertools.com/b2c/b2cmanuals.pgm>

DRAPER TOOLS LIMITED

HURSLEY ROAD

CHANDLER'S FORD

EASTLEIGH

HAMPSHIRE

SO53 1YF

UK

WEBSITE: www.drapertools.com

PRODUCT HELPLINE: +44 (0) 23 8049 4344

GENERAL FAX: +44 (0) 23 8026 0784

1.3 UNDERSTANDING THIS MANUALS SAFETY CONTENT:

WARNING! Information that draws attention to the risk of injury or death.

CAUTION! Information that draws attention to the risk of damage to the product or surroundings.

1.4 COPYRIGHT © NOTICE:

Copyright © Draper Tools Limited.

Permission is granted to reproduce this publication for personal & educational use only.

Commercial copying, redistribution, hiring or lending is prohibited.

No part of this publication may be stored in a retrieval system or transmitted in any other form or means without written permission from Draper Tools Limited.

In all cases this copyright notice must remain intact.

2. CONTENTS

2.1 CONTENTS

	PAGE CONTENT	PAGE
1	TITLE PAGE	
	1.1 INTRODUCTION	2
	1.2 REVISION HISTORY	2
	1.3 UNDERSTANDING THIS MANUAL	2
	1.4 COPYRIGHT NOTICE	2
2	CONTENTS	
	2.1 CONTENTS	3
3	GUARANTEE	
	3.1 GUARANTEE	4
4	INTRODUCTION	
	4.1 SCOPE	5
	4.2 SPECIFICATION	5
5	HEALTH & SAFETY INFORMATION	
	5.1 GENERAL SAFETY INSTRUCTIONS	6-8
	5.2 CONNECTION TO THE POWER SUPPLY	9
6	TECHNICAL DESCRIPTION	
	6.1 IDENTIFICATION	10
	6.2 MAIN COMPONENT DESCRIPTIONS	11
7	UNPACKING & CHECKING	
	7.1 PACKAGING	12
	7.2 WHAT'S IN THE BOX	12
8	PREPARING THE WELDER	
	8.1 LOCATION	13
	8.2 INSTALLING THE FLUX CORED FILLER WIRE	13
	8.3 NO GAS	14
9	BASIC WELDING OPERATIONS	
	9.1 ON/OFF SWITCH	15
	9.2 WELDING CURRENT REGULATION SWITCHES	15
	9.3 WIRE SPEED ADJUSTMENT	15
	9.4 THERMAL CUTOUT	15
	9.5 MIG WELDING PRINCIPLES	16
10	TROUBLESHOOTING	
	10.1 TROUBLESHOOTING	17
11	MAINTENANCE	
	11.1 MAINTENANCE	18
12	EXPLANATION OF SYMBOLS	
	12.1 EXPLANATION OF SYMBOLS	19
13	DISPOSAL	
	13.1 DISPOSAL	20
14	GLOSSARY	
	14.1 GLOSSARY	21
	DECLARATION OF CONFORMITY	ENCLOSED

3. GUARANTEE

3.1 GUARANTEE

Draper tools have been carefully tested and inspected before shipment and are guaranteed to be free from defective materials and workmanship for a period of 12 months from the date of purchase except where tools are hired out when the guarantee period is ninety days from the date of purchase.

A proof of purchase must be provided with the tool.

Should the machine develop any fault, please return the complete tool to your nearest authorized warranty repair agent or contact Draper Tools Limited, Chandler's Ford, Eastleigh, Hampshire, SO53 1YF. England. Telephone Sales Desk: (023) 8049 4333 or Product Helpline (023) 8049 4344.

If upon inspection it is found that the fault occurring is due to defective materials or workmanship, repairs will be carried out free of charge. This guarantee does not apply to normal wear and tear, nor does it cover any damage caused by misuse, careless or unsafe handling, alterations, accident, or repairs attempted or made by any personnel other than the authorised Draper warranty repair agent.

NOTE: If the tool is found not to be within the terms of warranty, repairs and carriage charges will be quoted and made accordingly.

This guarantee applies in lieu of any other guarantee expressed or implied and variations of its terms are not authorised.

Your Draper guarantee is not effective unless you can produce upon request a dated receipt or invoice to verify your proof of purchase within the 12 month period.

Please note that this guarantee is an additional benefit and does not affect your statutory rights.

Draper Tools Limited.

4. INTRODUCTION

4.1 SCOPE

This MIG welder is a limited duty machine designed to perform welding fabrication on a variety of steel types with flux cored filler wire.

4.2 SPECIFICATION

Stock no	63669
Part no	MIG100
Input:	
Voltage ($U_{1..V}$).....	230V~
Phase	1
Frequency.....	50Hz
Rated maximum Supply current (I_{1eff})	5A
Capacity.....	3000W
Output:	
No-load voltage ($U_{0..V}$)	28V
Welding current range (..A to ..A)	40A to 100A
Duty factor	
10%.....	100A
60%.....	40A
Protection fuse	13A
Suitable welding wire (mm)	0.6-0.9mm
Torch coupling.....	Direct
Insulation class.....	H
Cooling Device.....	Fan
Max. working Temperature.....	40°C
Dimensions	340× 345× 190mm
Weight (machine only)	13kg

5. HEALTH & SAFETY INFORMATION

5.1 GENERAL SAFETY INSTRUCTIONS

WARNING: When using electric tools basic safety precautions should always be followed to reduce the risk of fire, electric shock and personal injury including the following.

Read all these instructions before attempting to operate this product and save these instructions.

Electric shock can kill:

- Remove the plug from the socket before carrying out adjustment, servicing or maintenance.
- Allow 5 minutes waiting time for the capacitors to discharge before removing the panels for any maintenance operations
- Do not touch live electrical parts.
- Never use electrode holders or cables with damaged or deteriorated insulation.
- Keep working environment, equipment, cables and clothing free from grease, oil, moisture and dirt.
- Ensure welding machine has been correctly earthed and all panels are fitted securely.
- The operator must be insulated from the floor and work bench using a dry insulation mat.
- Wear isolating footwear and gloves that are in good condition, i.e. without holes.
- In hazardous conditions of increased electric shock always ensure a second person is present in case of accident.
- Never change electrodes with bare hands or damp gloves.
- Keep welding cables away from power cables.
- Regularly inspect the condition of the welding, earth, and power cables for signs of damage.
- Do not leave machine unattended and remove plug from socket when not in use.
- Do not use welding cables unsuitable for the amperage.
- Ensure earth clamp is adjacent to weld seam, secured to bare metal and when not in use is insulated for safety.
- Keep all equipment well maintained.
- The operator shall prevent gas cylinders in the vicinity of the work piece from becoming part of the welding circuit.

Fumes & gases can be harmful:

- The welding process generates hazardous fumes as a by-product. Inhalation of these fumes is hazardous to health.
- Keep your head away from the weld to avoid breathing the fumes.
- If welding in confined spaces ensure adequate ventilation and use a fume extractor.
- Welding fumes displace oxygen. Danger of suffocation.
- By-products of welding can react with other chemical vapours to produce a toxic/explosive environment.

Welding can cause fire or explosion:

- Arc welding and allied processes can cause fire and explosions and precautions shall be taken to prevent these hazards.
- Before starting a weld ensure the area is clear of flammable materials.
- Remove any inflammables to a safe distance, especially substances likely to generate a dangerous vapour.

5. HEALTH & SAFETY INFORMATION

- The welding arc can cause serious burns. Avoid contact with skin.
- Sparks and molten metal are cast out during welding. Take precautions to prevent fire igniting and wear protective clothing.
- Sparks and molten metal can pass through gaps. Be aware that fire can start out of sight. Flammables in a locked cabinet may not be safe.
- Do not weld pressurised containers.
- Do not weld tanks, drums or other vessels until they have been correctly cleaned/prepared for welding.
- Always have appropriate and fully maintained fire fighting equipment suitable for the materials used and for use in electrical environments available in close proximity at all times.
- Keep clothing free from oil and grease.
- Wear hat, flame-proof apron, woollen clothing, gloves, long sleeve tops with closed neck, trousers (without turn-ups) to cover non-slip boots.
- Protective head and shoulder coverings should be worn when overhead welding.
- Avoid taking any fuels with you e.g. cigarette lighters or matches.
- Hot spots and their immediate surroundings should be observed until their temperature has dropped to normal.

Personal Protection:

- The body should be protected by suitable clothing.
- The use of neck protection may be necessary against reflected radiation.
- Wear safety glasses when chipping, wire brushing, grinding or when near cooling welds as metal filings or slag can be thrown up. Fully enclosed goggles are advisable.
- Arc machines generate a magnetic field which is detrimental to pacemaker recipients. Consult your doctor before going near welding equipment/operations.
- The UV and IR radiation generated by welding is highly damaging to the eye, causing burns. This can also affect the skin. Protect the eyes and face.
- The face and eyes shall be protected by suitable welding shields equipped with appropriate ocular protection filters.
- Where environments are subject to pedestrians and traffic ensure a protective screen is used to avoid accidental arc glare.
- Do not weld in the vicinity of children or animals and ensure no one is looking before striking up.
- In the welding environment, damaging levels of noise can exist. Wear hearing protection if the process dictates.
- Do not touch hot equipment or metal. Allow the weld time to cool, use the correct tool and wear protective welding gauntlets.
- Wear flame retardant clothing (leather, wool, etc.).
- Take care when adjusting or maintaining the torch that it has had time to cool sufficiently and is disconnected.
- The arc generates
 - ultra-violet radiation (can damage skin and eyes);
 - visible light (can dazzle eyes and impair vision);
 - infra-red (heat) radiation (can damage skin and eyes);
- Such radiation can be direct or reflected from surfaces such as bright metals and light coloured objects.

5. HEALTH & SAFETY INFORMATION

Limitations:

- Do not use for;
 - operations in severe conditions (e.g. extreme climates, freezer applications, strong magnetic fields etc).
 - operations subject to special rules (e.g. potentially explosive atmospheres, mines etc).
 - operations that require ingress protection greater than IPX0, e.g. in rain or snow etc.

General:

- Training should be sought out in
 - the safe use of this equipment;
 - the processes;
 - the emergency procedures;
- Welding power sources are not to be used for pipe thawing.
- Take precautions against toppling over, if the power source shall be placed on a tilted plane.
- All equipment should be kept in good working condition, inspected and, when defective, promptly repaired or withdrawn from service - All equipment should be placed so that it does not present a hazard in passageways, on ladders or stairways, and should be operated in accordance with the manufacturer's instructions.
- In the vicinity of an arc, non-reflective curtains or screens shall be used to isolate persons from the arc radiation. A warning, e.g. a symbol for eye protection, should refer to the hazard of arc radiation.

MIG100		NO:	
1-⊕-1-		IEC 60974-1	
		40A/16.1V-100A/19V	
		X(%):	10 60
	U ₀ = 28V	I ₂ (A):	100 40
		U ₂ (V):	19 16.1
	U ₁ = 230V	I _{max} = 13A	I _{eff} = 5A
IP21S	H		

5. HEALTH & SAFETY INFORMATION

5.2. CONNECTION TO THE POWER SUPPLY

Make sure the power supply information on the machine's rating plate is compatible with the power supply you intend to connect it to.

This machine comes supplied with a UK standard 3 pin plug fitted. It is designed for connection to a domestic power supply rated at 230V AC.

Because it is constructed mostly of metal parts, it is a Class 1 machine; meaning, it must have an earth connection in the power supply. This is to prevent electrocution in the event of a failure.

Apart from replacing the fuse in the plug, no other electrical work is recommended on this machine.

6. TECHNICAL DESCRIPTION

6.1 IDENTIFICATION

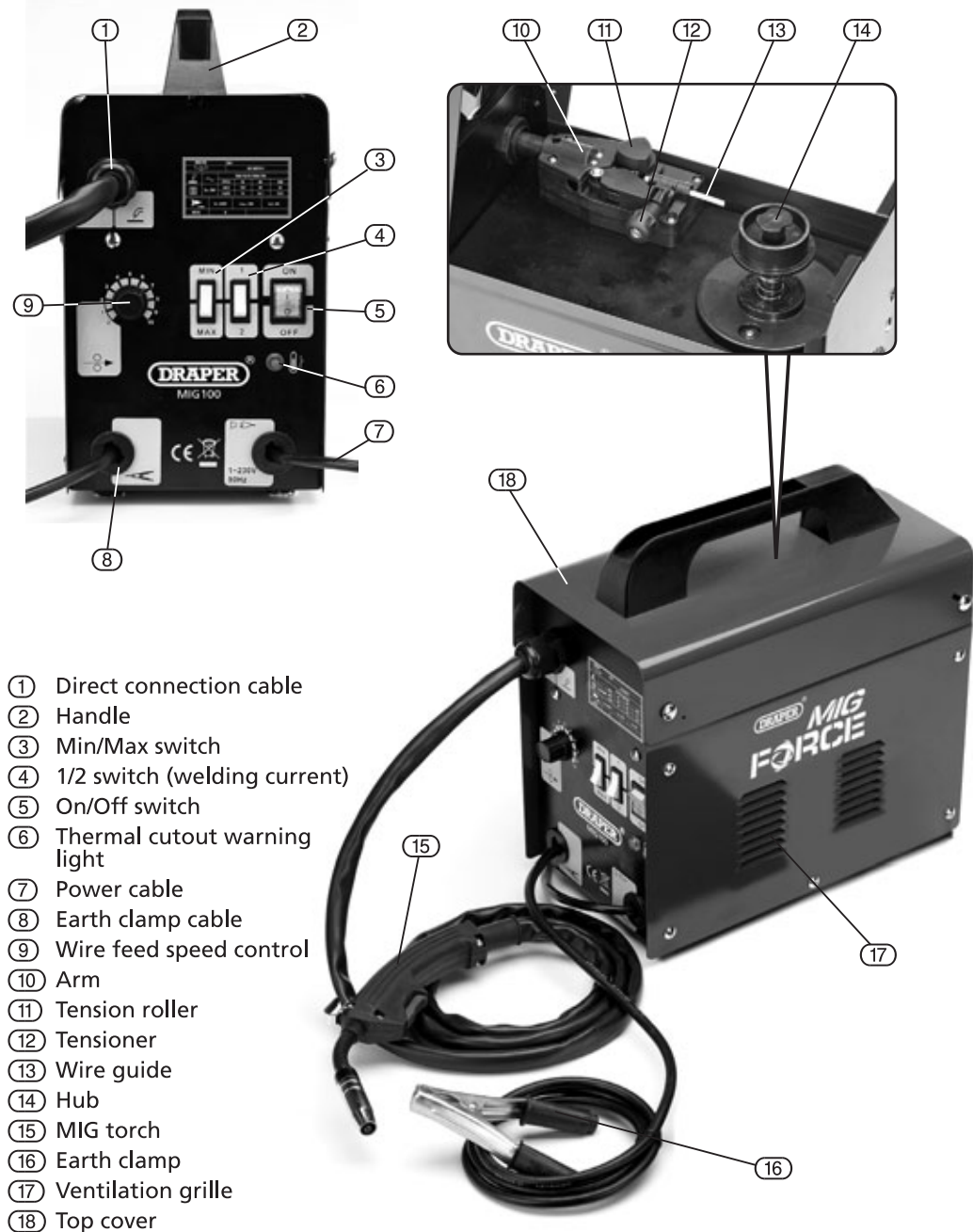

6. TECHNICAL DESCRIPTION

6.2 MAIN COMPONENT DESCRIPTIONS

Wire Drive Unit

The wire is fed down the torch lining by the wire drive motor. Tension of the rollers must be adjusted correctly to prevent the filler wire slipping or jamming.

7. UNPACKING & CHECKING

7.1 PACKAGING

Carefully remove the machine from the packaging and examine it for any sign of damage that may have happened during shipping. Lay the contents out and check them against the parts shown below. If any part is damaged or missing; please contact the Draper Helpline (the telephone number appears on the Title page) and do not attempt to use the machine.

The packaging material should be retained at least during the guarantee period: in case the machine needs to be returned for repair.

Warning! Some of the packaging materials used may be harmful to children. Do not leave any of these materials in the reach of children.

If any of the packaging is to be thrown away, make sure they are disposed of correctly; according to local regulations.

7.2 WHAT'S IN THE BOX?

As well as the machine, there are extra accessories.

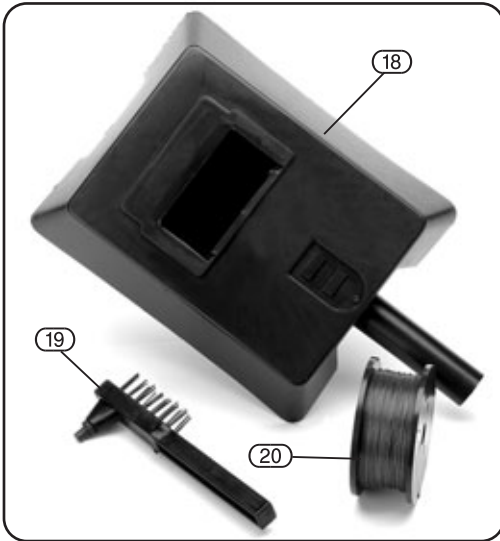

- (18) Hand held mask
- (19) Chipping hammer
- (20) Spool of flux cored wire

8. PREPARING THE WELDER

Warning! Do not make any adjustments, maintenance or servicing with the machine connected to the power supply.

8.1 LOCATION

Locate the machine in close proximity to the correct power supply and allow 500mm air gap around to ensure sufficient ventilation. There is one cooling fan located in the rear of the machine housing which must be kept clear. Equally, ensure no debris can be drawn into the machine.

Make certain the location does not pose any hazards as detailed in the safety instructions, before attempting to start the machine.

8.2 INSTALLING THE FLUX CORED FILLER WIRE - FIGS. 1 - 5

The welding machines are designed to accept the standard size drums of wire up to 1KG. The welding wire used must be of the flux cored type as this provides a means of shielding the weld pool from the atmosphere.

Do not let the filler wire become uncoiled or tangled as this will lead to problems with delivery to the welding torch.

Select the filler wire suitable for the parent metal and with a gauge to match the welder specification.

Note: If the welding machine is not regularly used, remove the wire which is prone to rusting and will cause feed problems next time.

- i. Lift the latch (18.1) to release the top cover (18).
- ii. Remove the large plastic ring (14.1) (turning it clockwise). Sit the reel on to the hub (14) and make sure the peg locates in the back of the reel. Refit the large plastic ring (14.1).
- iii. Fit the wire spool so that it feeds off the roll towards the wire drive unit.

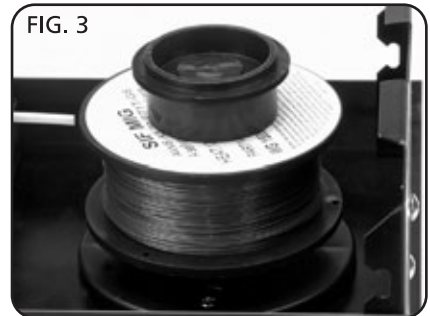
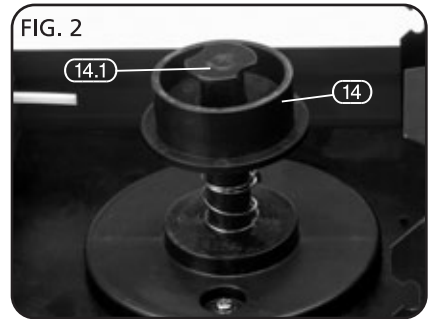
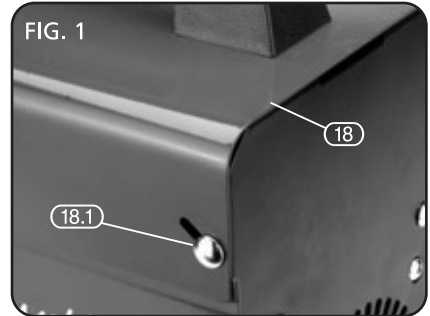

8. PREPARING THE WELDER

- iv. Loosen tensioner (12) anticlockwise enough to swing it outwards and lift arm (10), moving the tension roller (11).
- v. Trim 10cm of wire and discard it, before flattening out the next 15cm. Do not let the wire lose tension.
- vi. Pass the filler wire through the guide (13) and over the top of the drive roller fitted under securing nut (11). The drive roller comes with two grooves for different wire gauges. Remove nut to see the groove size that is NOT in use.

Note: The wire must sit in the appropriate groove for the wire gauge. The groove size is etched on the side of the roller. To reverse the roller, remove nut and flip the drive roller over before refitting nut (11).

- vii. Make sure the wire is well inside the torch liner before closing the arm and (10) tensioner (12).
- viii. Connect the welding machine to the power supply. Position the switch to 'on'.
- ix. Unscrew/remove the gas shroud (15.1) and with a small spanner unscrew and remove the tip (15.2). Pull the trigger (15.3) and observe the wire feed mechanism. If the wire is being fed correctly it will come out of the swan neck. Pass the tip over the wire and secure back onto the swan neck. Do not over tighten. Resecure the gas shroud and trim the wire back as required.

Note: Ensure the tip size matches the wire size prior to installing.

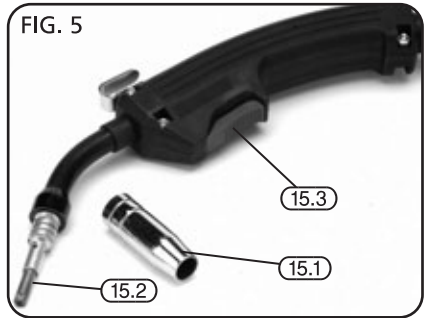
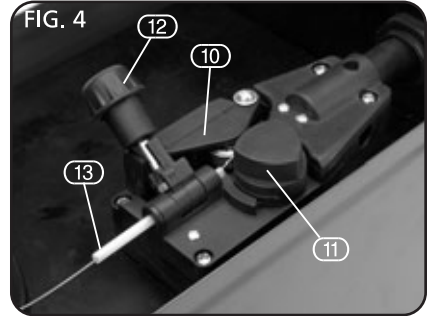

8.3 NO GAS WELDING PRINCIPLE- FIGS. 6 - 8

For a successful weld joint, the molten metal must be protected from contaminating gases found in the air. This is achieved by using a flux cored filler wire. The flux is produced as the wire melts.

The flux creates a coating over the weld and once cooled will need to be removed by chipping if off.

If allowed to cool naturally some areas of the flux may ping off of the weld by themselves due to thermal contraction for this reason it is recommended that eye protection is worn.

9. BASIC WELDING OPERATIONS

9.1 ON/OFF SWITCH

The on/off switch is a rocker switch. Press the top half in to switch the welder 'on' and the bottom half in to switch the welder 'off'.

9.2 WELDING CURRENT REGULATION SWITCHES - FIG. 9

The current regulation switches regulate the welders power in four steps. Min +1, Min +2 and Max +1, Max + 2. Regulate the welding current in conjunction with the wire speed to achieve the optimum arc for the workpiece thickness and type.

9.3 WIRE SPEED ADJUSTMENT - FIG. 10

Wire speed is dependent on material thickness and welding current. Being able to judge the correct wire speed based on the sound and quality of the weld will only come from practice.

- Too fast will result in holes blowing in the weld or the wire hitting the metal will force the torch backward.
- Too slow will result in the wire burning back to the torch into a ball and clogging the tip.

Note: When using the welder on a low amp setting/low wire speed, it is necessary that the wire drive tension is increased on the adjustment to avoid the spool stalling.

9.4 THERMAL CUT OUT

If the duty cycle of the welder is exceeded, the thermal cut out will activate to prevent damage to the internal components or further overheating.

When the thermal cut out warning light is lit, the welder must be left to cool down before it can be restarted.

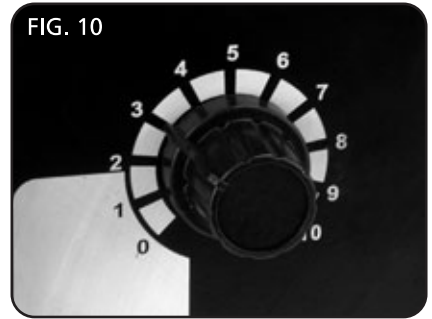
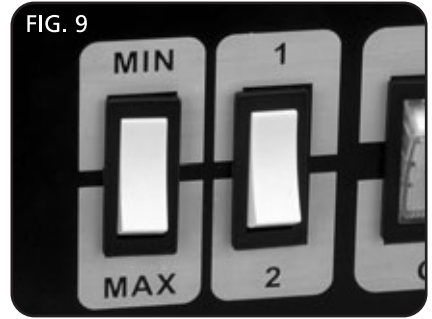

9. BASIC WELDING OPERATIONS

9.5 MIG WELDING PRINCIPLES

The Mig welding process allows two similar materials to be fused together without altering the properties of the material. The electric arc created between the electrode (the welding wire) and the work piece produces the required heat for turning the metal into a molten state. The gas creates a shield around the arc and the molten metal, on this welder the shield comes from the flux cored welding wire that must be used.

The area to be welded and the earth point must be clean of grease, dirt, paint and rust. Clean with a wire brush as necessary. Position the earth clamp as close as possible to the working area and ensure a tight grip is achieved.



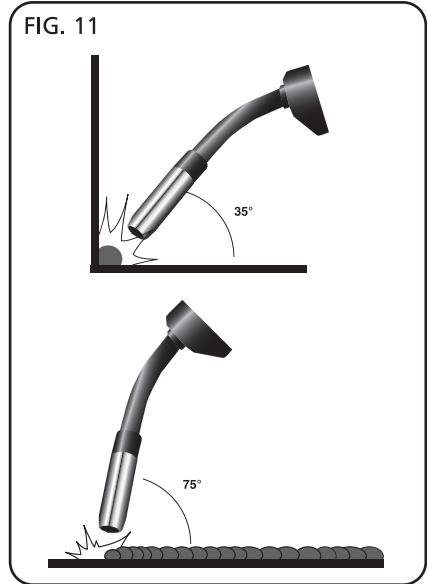

Select the welding current based on the thickness of the material. A thick piece will require a high current, however due to the duty cycle this will effect the welding time by significantly reducing it. A thin piece will only require minimal heat and so the current can be less. This will allow a longer period of welding. The position of the torch is critical to the arc and end results.

The position of the welding torch is important to achieve a good quality bead. Position the torch at approximately 35 vertically and 75 horizontally and up to 20mm* distance from the join. 20mm is the maximum that can be achieved on the maximum setting. Ensure the gas shroud remains clean of spatter. Likewise and more importantly the wire feed tip must be kept clean to avoid the wire becoming blocked or restricted.

Use of an anti-spatter spray (Draper Stock No.05709) will help keep the end result more tidy.

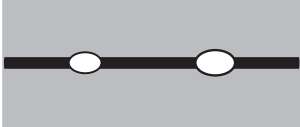

10. TROUBLESHOOTING

EXAMPLE	TERM	CAUSE
 A cross-sectional diagram of a butt joint weld. The weld metal is dark grey, and the base metal is light grey. The weld metal does not penetrate into the root of the joint, leaving a gap between the two pieces of metal.	Insufficient penetration	<ul style="list-style-type: none">- Incorrect arc distance- Welding current too low- Wire speed too low- Welding line not central to butt
 A cross-sectional diagram of a butt joint weld. The weld metal is dark grey, and the base metal is light grey. The weld metal is applied to the surface of both pieces of metal but does not fuse together, creating a distinct overlap.	Overlap	<ul style="list-style-type: none">- Wire size too large for application- Torch speed too slow
 A cross-sectional diagram of a butt joint weld. The weld metal is dark grey, and the base metal is light grey. The weld metal contains numerous small, dark, irregular spots, representing pits or inclusions.	Pitting	<ul style="list-style-type: none">- Contamination in the metal (eg rust)- Flux shield breakdown- Incorrect arc distance- Area cooling down too fast
 A cross-sectional diagram of a butt joint weld. The weld metal is dark grey, and the base metal is light grey. The weld metal has a rough, irregular, and wavy surface, indicating a poor quality weld.	Untidy weld	<ul style="list-style-type: none">- Unsteady torch movement- Worn wire tip
 A cross-sectional diagram of a butt joint weld. The weld metal is dark grey, and the base metal is light grey. The weld metal has burned through the base metal, creating two circular holes in the base metal.	Burn through	<ul style="list-style-type: none">- Current too high for material thickness- Torch speed too slow

11. MAINTENANCE

Warning: Remove the plug from the power supply. Periodically the welder must be checked as detailed below.

- Check the torch cable and ground cable connections.
- Clean the contact tip and the gas shroud with an iron brush. Replace if worn.
- Clean the outside of the welder with a damp cloth.
- Every time the wire spool is replaced:
 - Check the alignment, cleanliness and state of wear of the wire roll.
 - Remove any metal powder deposited on the wire feeder mechanism and then dry with compressed air.
- Check the condition of the warning labels.
- Replace any worn parts.

12. EXPLANATION OF SYMBOLS

12.1 EXPLANATION OF SYMBOLS



Warning!
Read the instruction manual



Warning! Disable the machine
before attempting to maintain it



WEEE
Do not dispose of Waste

Electrical & Electronic
Equipment in with domestic
rubbish



Danger! Electricity.
Keep your distance

13. DISPOSAL

13.1 DISPOSAL

- At the end of the machine's working life, or when it can no longer be repaired, ensure that it is disposed of according to national regulations.
- Contact your local authority for details of collection schemes in your area.

In all circumstances:

- Do not dispose of power tools with domestic waste.
- Do not incinerate.
- Do not abandon in the environment.
- Do not dispose of WEEE* as unsorted municipal waste.



* Waste Electrical & Electronic Equipment.

14. GLOSSARY

14.1 GLOSSARY

Alphabetical list of words relating to this manual

Duty cycle The duty cycle is the percentage of 10 minutes that the machine can weld for at a set amperage (10%=1min up to 100%=10mins). The higher the amperage, the lower the welding time.

Polarity The relative orientation of electric poles.

- **DRAPER TOOLS LIMITED,**
Hursley Road, Chandler's Ford,
Eastleigh, Hampshire. SO53 1YF. U.K.
- **Helpline:** (023) 8049 4344
- **Sales Desk:** (023) 8049 4333
- **General Enquiries:** (023) 8026 6355
- **Service/Warranty Repair Agent**
For aftersales servicing or warranty repairs, please
contact the Draper Tools Helpline for details of an
agent in your local area.

YOUR DRAPER STOCKIST

KCDH1116

