



INSTRUCTIONS FOR  
**1500W 230V 20L**  
**Wet & Dry/  
Shampoo Vacuum Cleaner**

Stock No.75442 Part No.SWD1500

**IMPORTANT:** PLEASE READ THESE INSTRUCTIONS CAREFULLY TO ENSURE THE SAFE AND EFFECTIVE USE OF THIS PRODUCT.



CE

**DRAPER**®

## GENERAL INFORMATION

These instructions accompanying the product are the original instructions. This document is part of the product, keep it for the life of the product passing it on to any subsequent holder of the product. Read all these instructions before assembling, operating or maintaining this product.

This manual has been compiled by Draper Tools describing the purpose for which the product has been designed, and contains all the necessary information to ensure its correct and safe use. By following all the general safety instructions contained in this manual, it will ensure both product and operator safety, together with longer life of the product itself.

All photographs and drawings in this manual are supplied by Draper Tools to help illustrate the operation of the product.

Whilst every effort has been made to ensure the accuracy of information contained in this manual, the Draper Tools policy of continuous improvement determines the right to make modifications without prior warning.

# 1. TITLE PAGE

---

## **1.1 INTRODUCTION:**

USER MANUAL FOR:

**1500W 230V 20L WET & DRY/ SHAMPOO VACUUM CLEANER**

Stock no. 75442

Part no. SWD1500

## **1.2 REVISIONS:**

Date first published September 2015.

---

---

---

As our user manuals are continually updated, users should make sure that they use the very latest version.

Downloads are available from: <http://www.drapertools.com/manuals>

DRAPER TOOLS LIMITED

HURSLEY ROAD

CHANDLER'S FORD

EASTLEIGH

HAMPSHIRE

SO53 1YF

UK

WEBSITE: [www.drapertools.com](http://www.drapertools.com)

PRODUCT HELPLINE: +44 (0) 23 8049 4344

GENERAL FAX: +44 (0) 23 8026 0784

## **1.3 UNDERSTANDING THIS MANUALS SAFETY CONTENT:**

**WARNING!** Information that draws attention to the risk of injury or death.

**CAUTION!** Information that draws attention to the risk of damage to the product or surroundings.

## **1.4 COPYRIGHT © NOTICE:**

Copyright © Draper Tools Limited.

Permission is granted to reproduce this publication for personal & educational use only.

Commercial copying, redistribution, hiring or lending is prohibited.

No part of this publication may be stored in a retrieval system or transmitted in any other form or means without written permission from Draper Tools Limited.

In all cases this copyright notice must remain intact.

---

# 2. CONTENTS

## 2.1 CONTENTS

|    | <i>Page content</i>                                      | <i>Page</i> |
|----|--|-------------|
| 1  | TITLE PAGE   |             |
|    | 1.1 INTRODUCTION .....                                   | 2           |
|    | 1.2 REVISION HISTORY .....                               | 2           |
|    | 1.3 UNDERSTANDING THIS MANUAL .....                      | 2           |
|    | 1.4 COPYRIGHT NOTICE .....                               | 2           |
| 2  | CONTENTS   |             |
|    | 2.1 CONTENTS .....                                       | 3           |
| 3  | GUARANTEE  |             |
|    | 3.1 GUARANTEE .....                                      | 4           |
| 4  | INTRODUCTION   |             |
|    | 4.1 SCOPE .....  | 5           |
|    | 4.2 SPECIFICATION .....                                  | 5           |
|    | 4.3 HANDLING & STORAGE .....                             | 5           |
| 5  | HEALTH & SAFETY INFORMATION                              |             |
|    | 5.1 GENERAL SAFETY INSTRUCTIONS FOR POWER TOOL USE ..... | 6           |
|    | 5.2 CONNECTION TO THE POWER SUPPLY .....                 | 7           |
| 6  | TECHNICAL DESCRIPTION                                    |             |
|    | 6.1 IDENTIFICATION .....                                 | 8           |
| 7  | UNPACKING & CHECKING                                     |             |
|    | 7.1 PACKAGING .....                                      | 9           |
|    | 7.2 WHAT'S IN THE BOX? .....                             | 9           |
| 8  | INITIAL MACHINE ASSEMBLY                                 |             |
|    | 8.1 FITTING THE PUSH HANDLE .....                        | 10          |
|    | 8.2 FITTING THE REAR WHEELS .....                        | 10          |
|    | 8.3 FITTING THE CASTORS .....                            | 10          |
| 9  | VACUUMING DRY DUST AND DIRT                              |             |
|    | 9.1 EMPTY TANK .....                                     | 11          |
|    | 9.2 REMOVAL OF THE ANTI-FOAM FILTER .....                | 11          |
|    | 9.3 FIXING CARTRIDGE FILTER .....                        | 11          |
|    | 9.4 FIXING THE PAPER DUSTBAG .....                       | 11          |
|    | 9.5 REFITTING THE MOTOR HOUSING .....                    | 12          |
|    | 9.6 CONNECTING ATTACHMENTS .....                         | 12          |
|    | 9.7 SWITCHING ON .....                                   | 13          |
| 10 | VACUUMING FLUIDS   |             |
|    | 10.1 EMPTY TANK .....                                    | 14          |
|    | 10.2 REMOVE THE CARTRIDGE FILTER .....                   | 14          |
|    | 10.3 FITTING ANTI-FOAM FILTER .....                      | 14          |
|    | 10.4 REFIT MOTOR HOUSING .....                           | 14          |
|    | 10.5 FITTING LARGE FLUID NOZZLE .....                    | 15          |
|    | 10.6 SWITCHING ON .....                                  | 15          |
|    | 10.7 WATER ON LARGE AREAS .....                          | 15          |
| 11 | INJECTION/EXTRACTION SHAMPOO                             |             |
|    | 11.1 ATTACH THE SHAMPOO DELIVERY HOSE .....              | 16          |
|    | 11.2 FILL THE SHAMPOO TANK .....                         | 16          |
|    | 11.3 REFIT THE MOTOR HOUSING .....                       | 16          |
|    | 11.4 CONNECTING THE SHAMPOO INLET HOSE AND FILTER .....  | 17          |
|    | 11.5 ATTACHING THE LARGE FLUID NOZZLE .....              | 17          |
|    | 11.6 ATTACHING THE SMALL FLUID NOZZLE .....              | 18          |
|    | 11.7 SWITCHING ON .....                                  | 18          |
|    | 11.8 INJECTION/EXTRACTION CLEANING OF HARD FLOORS .....  | 19          |
|    | 11.9 INJECTION/EXTRACTION CLEANING OF CARPETS .....      | 19          |
|    | 11.10 INJECTION/EXTRACTION CLEANING OF UPHOLSTERY .....  | 19          |
| 12 | MAINTENANCE & PARTS REPLACEMENT                          |             |
|    | 12.1 TROUBLESHOOTING GUIDE .....                         | 20          |
| 13 | OPTIONAL ACCESSORIES                                     |             |
|    | 13.1 OPTIONAL ACCESSORIES .....                          | 21          |
| 14 | EXPLANATION OF SYMBOLS/PICTOGRAMS                        |             |
|    | 14.1 EXPLANATION OF SYMBOLS/PICTOGRAMS .....             | 22          |
| 15 | DISPOSAL   |             |
|    | 15.1 DISPOSAL .....                                      | 23          |
|    | DECLARATION OF CONFORMITY .....                          | ENCLOSED    |

## 3. GUARANTEE

---

### **3.1 GUARANTEE**

Draper tools have been carefully tested and inspected before shipment and are guaranteed to be free from defective materials and workmanship.

Should the tool develop a fault, please return the complete tool to your nearest distributor or contact Draper Tools Limited, Chandler's Ford, Eastleigh, Hampshire, SO53 1YF. England. Telephone Sales Desk: (023) 8049 4333 or Product Helpline (023) 8049 4344.

A proof of purchase must be provided with the tool.

If upon inspection it is found that the fault occurring is due to defective materials or workmanship, repairs will be carried out free of charge. This guarantee period covering parts/labour is twelve months from the date of purchase except where tools are hired out when the guarantee period is ninety days from the date of purchase. This guarantee does not apply to normal wear and tear, nor does it cover any damage caused by misuse, careless or unsafe handling, alterations, accidents, or repairs attempted or made by any personnel other than the authorised Draper warranty repair agent.

Note: If the tool is found not to be within the terms of warranty, repairs and carriage charges will be quoted and made accordingly.

This guarantee applies in lieu of any other guarantee expressed or implied and variations of its terms are not authorised.

Your Draper guarantee is not effective unless you can produce upon request a dated receipt or invoice to verify your proof of purchase within the guarantee period.

Please note that this guarantee is an additional benefit and does not affect your statutory rights.

**Draper Tools Limited.**

## 4. INTRODUCTION

---

### 4.1 SCOPE

This machine is designed to pick up both wet and dry material with the added facility of shampooing. Ideally suited for domestic and DIY use around the home.

### 4.2 SPECIFICATION

|                              |                             |
|------------------------------|-----------------------------|
| Stock no .....               | 75442                       |
| Part no .....                | SWD1500                     |
| Motor:                       |                             |
| Rated voltage .....          | 230V~                       |
| Rated frequency .....        | 50Hz                        |
| Rated input .....            | 1500W                       |
| Insulation class.....        | Class II (double insulated) |
| Maximum vacuum pressure..... | 18Kpa (180mbar)             |
| Maximum air flow .....       | 65L/sec                     |
| Tank capacity - liquid ..... | 20L                         |
| Shampoo tank volume .....    | 4L                          |
| Sound pressure level .....   | 75dB(A)                     |
| Dimensions (D × W × H).....  | 400mm × 450mm × 560mm       |
| Appliance weight (net).....  | 12kg                        |

### 4.3 HANDLING & STORAGE

The environment will have a negative result on its operation if you are not careful. If the air is damp, components will rust. If the machine is unprotected from dust and debris; components will become clogged: And if not cleaned and maintained correctly or regularly the machine will not perform at its best.

## 5. HEALTH & SAFETY INFORMATION

---

### 5.1 GENERAL SAFETY INSTRUCTIONS FOR POWER TOOL USE

When using any type of power tool there are steps that should be taken to make sure that you, as the user, remain safe.

Common sense and a respect for the tool will help reduce the risk of injury.

**Read the instruction manual fully.** Do not attempt any operation until you have read and understood this manual.

Most important you must know how to safely start and stop this machine, especially in an emergency.

**Keep the work area tidy and clean.** Attempting to clear clutter from around the machine during use will reduce your concentration. Mess on the floor creates a trip hazard. Any liquid spilt on the floor could result in you slipping.

**Find a suitable location.** If the machine is bench mounted; the location should provide good natural light or artificial lighting as a replacement. Avoid damp and dust locations as it will have a negative effect on the machine's performance.

If the machine is portable; do not expose the tool to rain. In all cases do not operate power tools near any flammable materials.

**Beware of electric shock.** Avoid contact with earthed surfaces; because they can conduct electricity if there is an electrical fault with the power tool. Always protect the power cable and route it away from danger.

**Keep bystanders away.** Children, onlookers and passers by must be restricted from entering the work area for their own protection. The barrier must extend a suitable distance from the tool user.

**Unplug and house all power tools that are not in use.** A power tool should never be left unattended while connected to the power supply. They must be housed in a suitable location, away locked up and from children.

**Do not overload or misuse the tool.** All tools are designed for a purpose and are limited to what they are capable of doing. Do not attempt to use a power tool (or adapt it in any way) for an application it is not designed for. Select a tool appropriate for the size of the job. Overloading a tool will result in tool failure and user injury: This covers the use of accessories.

**Dress properly.** Loose clothing, long hair and jewellery are all dangerous because they can become entangled in moving machinery: This can also result in parts of body being pulled into the machine.

Clothing should be close fitted, with any long hair tied back and jewellery and neck ties removed. Footwear must be fully enclosed and have a nonslip sole.

**Wear personal protective equipment (PPE).** Dust, noise, vibration and **swarf** can all be dangerous if not suitably protected against. If the work involving the power tool creates dust or fumes; wear a dust mask. Vibration to the hand, caused by operating some tools for longer periods must be protected against. Wear vibration reducing gloves and allow long breaks between uses. Protect against dust and **swarf** by wearing approved safety goggles or a face shield. These are some of the more common hazards and preventions; however, always find out what hazards are associated with the machine/work process and wear the most suitable protective equipment available.

**Do not breathe contaminated air.** If the work creates dust or fumes; connect the machine (if possible) to an extraction system either locally or remotely. Working outdoors can also help if possible.

**Move the machine as instructed.** If the machine is hand held, do not carry it by the power supply cable. If the product is heavy; employ a second or third person to help move it safely or use a mechanical device. Always refer to the instructions for the correct method.

**Do not overreach.** Extending your body too far can result in a loss of balance and you falling. This could be from a height or onto a machine and will result in injury.

**Maintain your tools correctly.** A well maintained tool will do the job safely. Replace any damaged or missing parts immediately with original parts from the manufacturer. As applicable; keep blades sharp; moving parts clean, oiled or greased; handles clean; and emergency devices working.

## 5. HEALTH & SAFETY INFORMATION

---

**Wait for the machine to stop.** Unless the machine is fitted with a safety brake; some parts may continue to move due to momentum. Wait for all parts to stop; then unplug it from the power supply before making any adjustments, carrying out maintenance operations or just finishing using the tool.

**Remove and check setting tools.** Some machinery requires the use of additional tools or keys to set, load or adjust the power tool. Before starting the power tool always check to make certain they have been removed and are safely away from the machine.

**Prevent unintentional starting.** Before plugging any machine in to the power supply, make sure the switch is in the OFF position. If the machine is portable; do not hold the machine near the switch and take care when putting the machine down; that nothing can operate the switch.

**Carefully select an extension lead.** Some machines are not suitable for use with extension leads. If the tool is designed for use outdoors; use an extension lead also suitable

for that environment. When using an extended lead, select one capable of handling the current (amps) drawn by the machine in use. Fully extend the lead regardless of the distance between the power supply and the tool. Excess current (amps) and a coiled extension lead will both cause the cable to heat up and can result in fire.

**Concentrate and stay alert.** Distractions are likely to cause an accident. Never operate a power tool if you are under the influence of drugs (prescription or otherwise), including alcohol or if you are feeling tired. Being disorientated will result in an accident.

**Have this tool repaired by a qualified person.** This tool is designed to conform to the relevant international and local standards and as such should be maintained and repaired by someone qualified; using only original parts supplied by the manufacturer: This will ensure the tool remains safe to use.

### 5.2 CONNECTION TO THE POWER SUPPLY

**Caution:** Risk of electric shock. Do not open.

This appliance is supplied with a moulded 3 pin mains plug for your safety. The value of the fuse fitted is marked on the pin face of the plug. Should the fuse need replacing, ensure the substitute is of the correct rating, approved to BS1362 and ASTA or BS Kite marked.

ASTA 

BSI 

The fuse cover is removable with a small plain slot screwdriver. Ensure the fuse cover is replaced before attempting to connect the plug to an electrical outlet. If the cover is missing, a replacement must be obtained or the plug replaced with a suitable type.

If a replacement plug is to be fitted this must be carried out by a qualified electrician.

The damaged or incomplete plug, when cut from the cable should be disabled to prevent connection to a live electrical outlet.

This appliance is Class II<sup>†</sup> and is designed for connection to a power supply matching that detailed on the rating label and compatible with the plug fitted.

If an extension lead is required, use an approved and compatible lead rated for this appliance. Follow all the instruction supplied with the extension lead.

<sup>†</sup>Double insulated : This product requires no earth connection as supplementary insulation is applied to the basic insulation to protect against electric shock in the event of failure of the basic insulation.

**Important:** On products exceeding 2000W it is recommended that the power cable and/or extension cable are fully unwound before a connection is made to the power supply. However, ensure the residual cable does not pose a trip hazard.

# 6. TECHNICAL DESCRIPTION

## 6.1 IDENTIFICATION

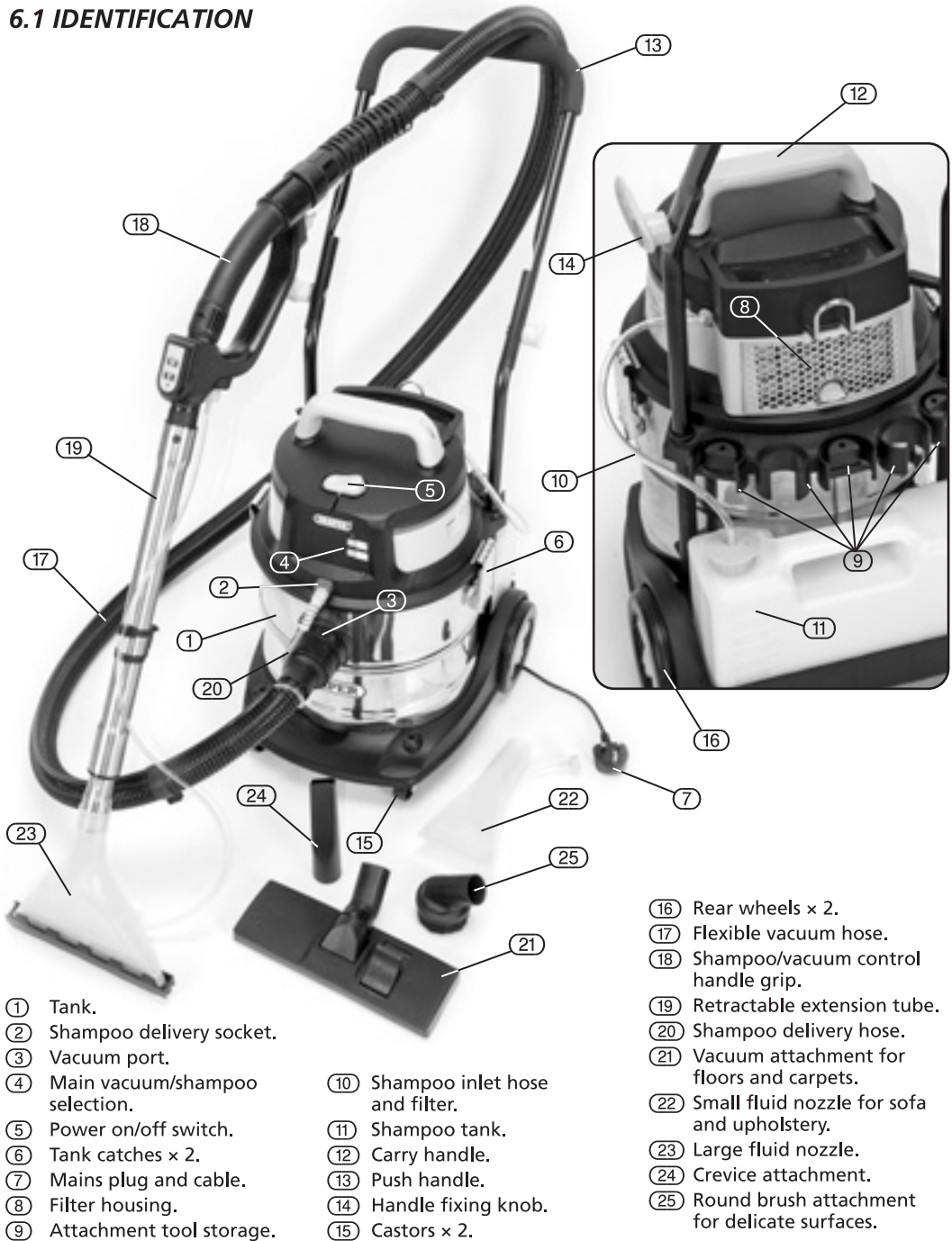

- ① Tank.
- ② Shampoo delivery socket.
- ③ Vacuum port.
- ④ Main vacuum/shampoo selection.
- ⑤ Power on/off switch.
- ⑥ Tank catches × 2.
- ⑦ Mains plug and cable.
- ⑧ Filter housing.
- ⑨ Attachment tool storage.

- ⑩ Shampoo inlet hose and filter.
- ⑪ Shampoo tank.
- ⑫ Carry handle.
- ⑬ Push handle.
- ⑭ Handle fixing knob.
- ⑮ Castors × 2.

- ⑯ Rear wheels × 2.
- ⑰ Flexible vacuum hose.
- ⑱ Shampoo/vacuum control handle grip.
- ⑲ Retractable extension tube.
- ⑳ Shampoo delivery hose.
- ㉑ Vacuum attachment for floors and carpets.
- ㉒ Small fluid nozzle for sofa and upholstery.
- ㉓ Large fluid nozzle.
- ㉔ Crevice attachment.
- ㉕ Round brush attachment for delicate surfaces.



# 7. UNPACKING & CHECKING

## 7.1 PACKAGING

Carefully remove the shampoo/vacuum cleaner from the packaging and examine it for any sign of damage that may have happened during shipping. Lay the contents out and check them against the parts shown below. If any part is damaged or missing; please contact the Draper Helpline (the telephone number appears on the Title page) and do not attempt to use the vacuum cleaner.

The packaging material should be retained at least during the guarantee period: in case the machine needs to be returned for repair.

**Warning!** Some of the packaging materials used may be harmful to children. Do not leave any of these materials in the reach of children.

If any of the packaging is to be thrown away, make sure they are disposed of correctly; according to local regulations.

## 7.2 WHAT'S IN THE BOX?

As well as the shampoo/vacuum cleaner; there are several parts not fitted or attached to it.

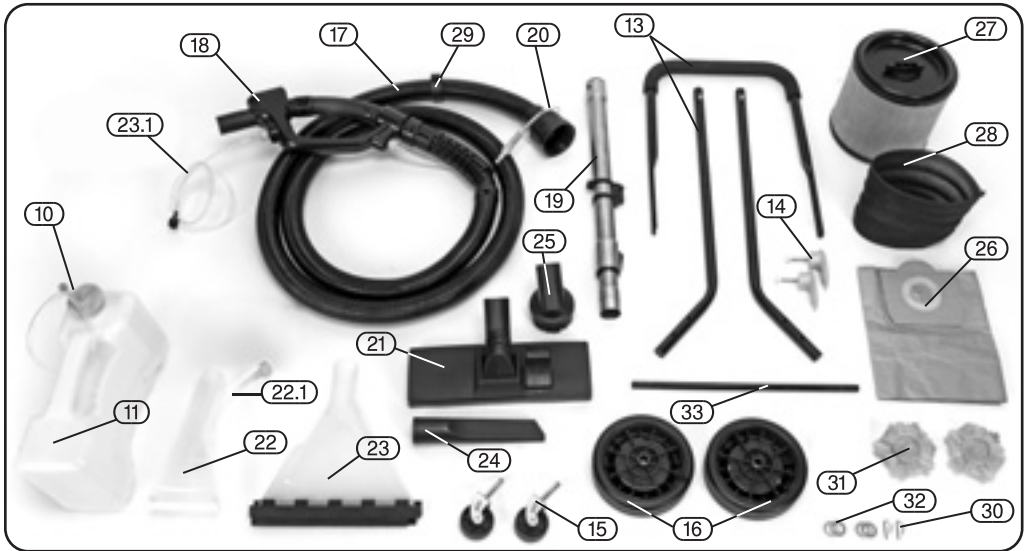

- |  |  |  |
|--|--|--|
| (10) Shampoo inlet hose and filter.      | (20) Shampoo delivery hose (main).                 | (25) Brush attachment for delicate surfaces. |
| (11) Shampoo tank.                       | (21) Vacuum attachment for floors and carpets.     | (26) Paper dust bag.                         |
| (13) Push handle.                        | (22) Small fluid nozzle for sofa and upholstery.   | (27) Cartridge filter.                       |
| (14) Handle fixing knob.                 | (22.1) Shampoo delivery hose (small fluid nozzle). | (28) Anti-foam filter.                       |
| (15) Castors x 2.                        | (23) Large fluid nozzle.                           | (29) Hose clips.                             |
| (16) Rear wheels x 2.                    | (23.1) Shampoo delivery hose (large fluid nozzle). | (30) Wheel locking pins x 2.                 |
| (17) Flexible vacuum hose.               | (24) Crevice nozzle.                               | (31) Wheel hub caps x 2.                     |
| (18) Shampoo/vacuum control handle grip. |  | (32) Wheel washers x 4.                      |
| (19) Retractable extension tube.         |  | (33) Wheel axle.                             |

## 8. INITIAL MACHINE ASSEMBLY

### 8.1 FITTING THE PUSH HANDLE – FIGS. 1 – 2

**Note:** The procedure for attaching the push handle to the machine **must** be performed before the fitting of the 2 rear wheels.

- As illustrated in Fig.1, assemble the main hand grip part of the push handle (13.1) with the two uprights (13.2) and (13.3) with the supplied bolts (13.4), fastening on each side the outer framework with with the two power cord wraps (14).
- Making sure it is the correct way around (see the identification illustration on page 8), slide the completed handle assembly through the holes in the tool storage section at the rear of the tank (9) and then further down into the slots located in the base of the vacuum cleaner (1.1), pressing down firmly until it snap-fits into place.
- To secure on each side, tighten the supplied screw through the hole situated inside the rear wheel housing (16.1) and on through into the hole in the tubular frame of the handle (13).

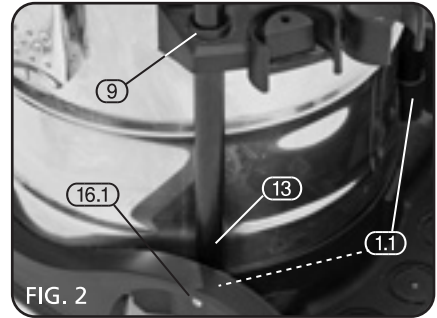
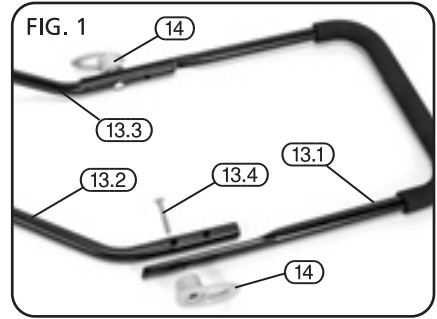

### 8.2 FITTING THE REAR WHEELS – FIG. 3

- Using one end of the wheel axle (33), pass one of the 2 wheel locking pins (30) through the hole at the end of the axle. Matching the sequence shown in Fig. 3, slide on one of the wheel washers (32) over the open end of the axle, followed by one of the rear wheels (16) (making sure that it is the correct way around as shown), followed by a further wheel washer (32).
- Pass the opposite end of the axle (33) through the open end of the moulded bracket situated inside the wheel housing, and out through to the other side of the machine.
- On the opposite side, thread a further washer (32) over the other end of the axle followed by the other rear wheel (16).
- Thread on the remaining washer (32) and then fasten in place using the remaining wheel locking pin (30).
- Snap-fit the 2 wheel hub caps (31) in place to complete the rear wheel assembly.

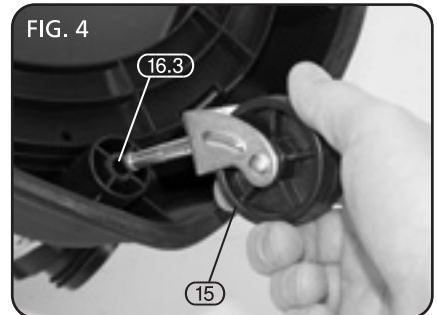
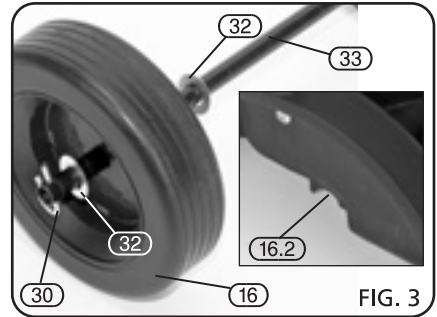

### 8.3 FITTING THE CASTORS – FIG. 4

- Snap-fit the 2 castors (15) into the holes located on the machine base (16.3) to complete the assembly.

## 9. VACUUMING DRY DUST AND DIRT

### 9.1 EMPTY TANK – FIG. 5

Dispose of any liquid which may have been picked up previously.

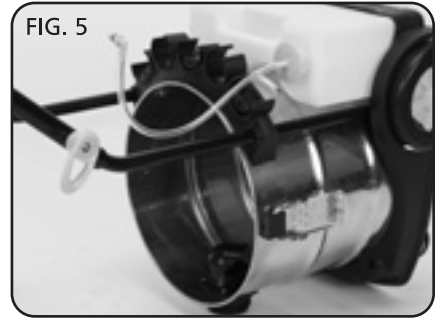

### 9.2 REMOVAL OF THE ANTI-FOAM FILTER – FIG. 6

If already fitted, remove the anti-foam filter (28).

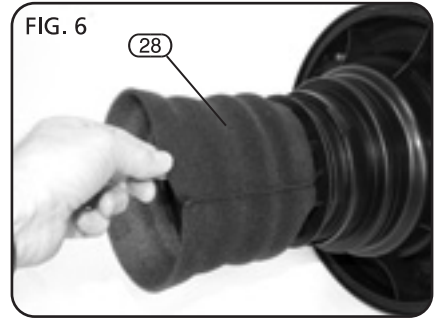

### 9.3 FIXING CARTRIDGE FILTER – FIG. 7

The cartridge filter (27) must now be fitted by placing it below the motor head as shown, and then securing it in place by turning the fixing knob (27.1) clockwise.

**NOTE:** The cleaner comes complete with a cleanable cartridge filter. The cartridge filter should be cleaned using a soft brush at regular intervals. This will ensure a longer service life and higher suction power. If the cartridge filter is not used when vacuuming dry dust and dirt motor damage will occur.

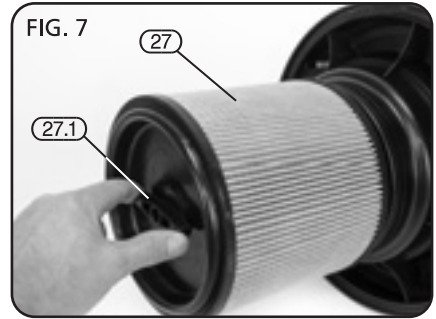

### 9.4 FIXING THE PAPER DUSTBAG – FIG. 8

Fix the paper dustbag (26) to the inner side of the hose connector in the tank. When using the paper dust bag, the life of the cartridge filter will be prolonged. The paper dustbag **NEVER** replaces the cartridge filter but, the filter cartridge can be used without the paper dustbag.

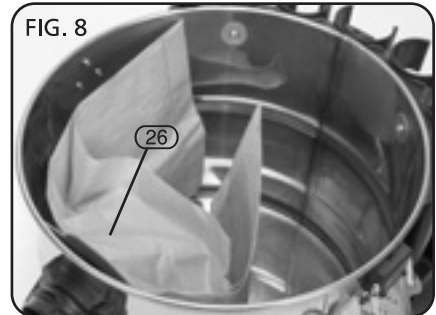

## 9. VACUUMING DRY DUST AND DIRT

### 9.5 REFITTING THE MOTOR HOUSING – FIG. 9

Place housing on top as shown, then secure using the two tank catches (6).



### 9.6 CONNECTING ATTACHMENTS – FIGS. 10 - 12

Insert the the head of flexible vacuum hose (17) into the shampoo/vacuum control handle grip (18), and twist to lock in place. The grip provides a suction power regulating device (18.1). To obtain full suction power the regulator should be closed.

The grip also incorporates a remote on/off control (18.2) to operate the machine for shampoo/vacuuming operations.

The retractable extension tube (19) can now be attached, if required, to the handle grip and used in conjunction with the supplied attachments.

The vacuum attachment for floors and carpets (21) can be used on hard floors - parquet, cork, vinyl, ceramic, etc. Any of the other attachments may be used depending upon the specific application. They are attached with a tight push fit.

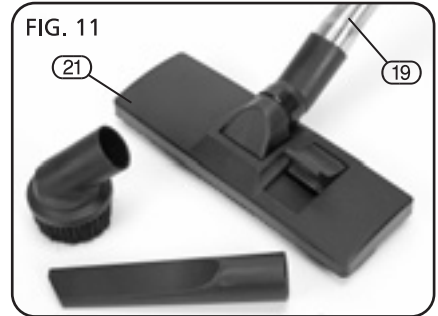
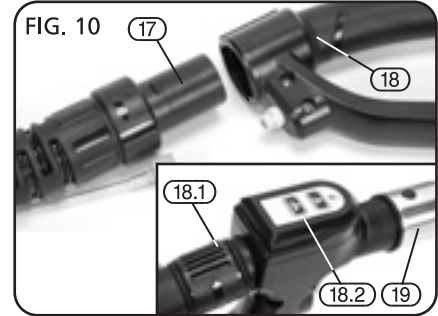

# 9. VACUUMING DRY DUST AND DIRT

## 9.7 SWITCHING ON – FIGS. 13 – 15

Connect the vacuum cleaner to the power supply and switch the vacuum cleaner 'on' by pushing the power on/off switch (5).

- Use the machine in vacuum only mode by pressing the button identified by the symbol below situated on the front panel of the machine (4.1).



Vacuum cleaning selection.

### DO NOT SELECT THE SHAMPOO OPERATION.

Now use the vacuum cleaner as normal.

**Note:** After selecting 'on' from the main switch, vacuum cleaning mode can be also selected from the button (18.1) located on the remote control handle grip (18).

Dustbags and filters are available from your local Draper Power tool stockist.

### ATTENTION: EXPLOSION AND FIRE HAZARD!

Never vacuum asbestos, inflammable fluids, such as petrol, oil, solvents, etc. Do not work near inflammable fluids or gas. Never vacuum fluids or material hotter than 60°C, such as burning cigarettes, ashes, glowing coals, etc. If cable becomes damaged replace immediately. Always keep the filter cartridge clean; for maximum performance.



FIG. 13

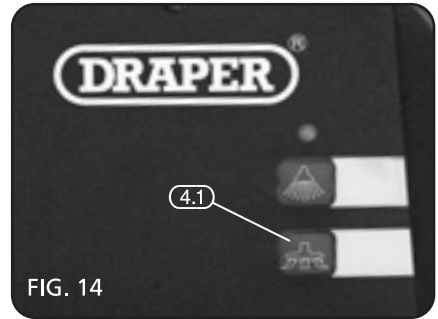

FIG. 14

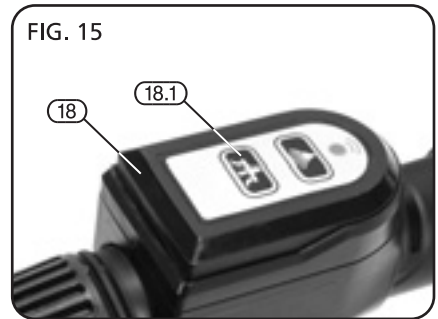
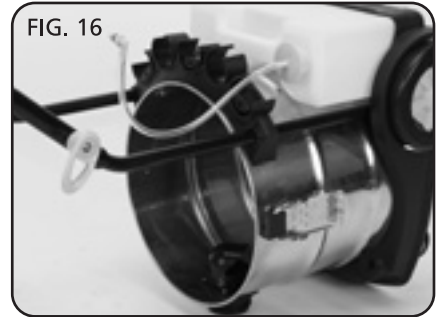

FIG. 15

## 10. VACUUMING FLUIDS

### 10.1 EMPTY TANK – FIG. 16

If fitted, remove the paper dust bag and empty the tank to dispose of any dirt/dust which may have been picked up previously.



### 10.2 REMOVE THE CARTRIDGE FILTER – FIG. 17

If in place, the cartridge filter (27) must now be removed by turning the fixing knob (27.1) anti-clockwise and sliding off of the motor head.

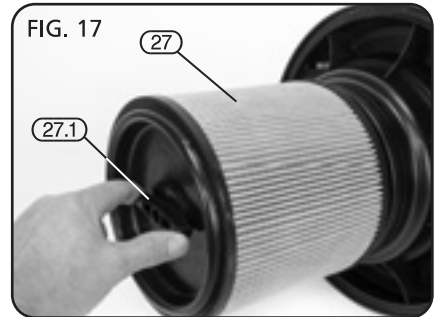

### 10.3 FITTING THE ANTI-FOAM FILTER – FIG. 18

Slide the filter (28) over the float cage.

**NEVER VACUUM DRY DUST AND DIRT WITH THIS FILTER FITTED AS IT WILL PROVIDE LITTLE OR NO PROTECTION RESULTING IN MOTOR DAMAGE.**

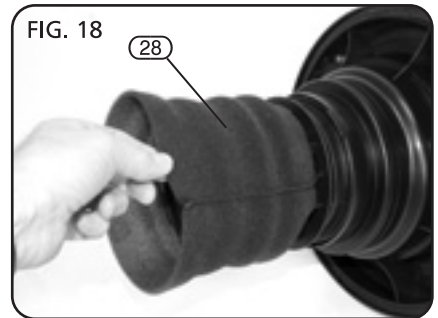

### 10.4 REFIT MOTOR HOUSING – FIG. 19

Secure using the two tank catches (6).



# 10. VACUUMING FLUIDS

**Note:** When the fluids have reached the highest permissible level in the tank, the float regulator will cover the motor filter causing the motor to work harder, it will become noisier, at this point turn off and empty the tank.

## 10.5 FITTING THE LARGE FLUID NOZZLE – FIG. 20

Fit the large fluid nozzle (23) to the retractable extension tube (19).

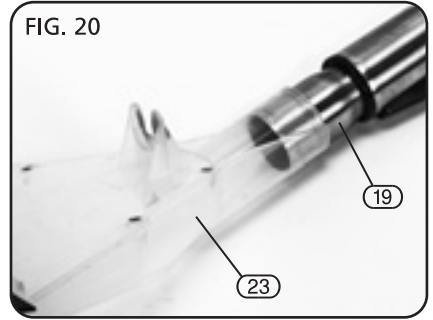

## 10.6 SWITCH ON – FIG. 21

Connect the vacuum cleaner to the power supply and switch the vacuum cleaner 'on' by pushing the power 'on/off' switch (5).

- Use the machine in vacuum only mode by pressing the button identified by the symbol below situated on the front panel of the machine (4.1).



Vacuum cleaning selection.

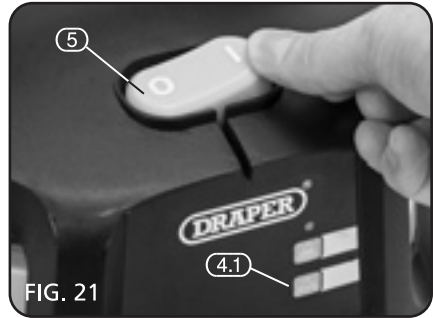

## DO NOT SELECT THE SHAMPOO OPERATION.

Now use the vacuum cleaner as normal.

**Note:** After selecting 'on' from the main switch, vacuum cleaning mode can be also selected using the remote control located on the shampoo/vacuum control handle grip (18).

## 10.7 WATER ON LARGE AREAS – FIG. 22

**Note:** The large fluid nozzle (23) should be used on floors and other flat surface areas where the water to be picked up has dispersed over a large area but is only shallow.

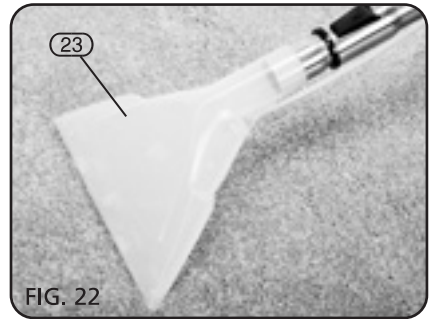

The crevice nozzle attachment (24) should be used when the water level is too high to use the large fluid nozzle.

**Note:** To ensure the air flow is adequate we recommend that the end of the nozzle is not totally immersed.



# 11. INJECTION/EXTRACTION SHAMPOO

## 11.1 ATTACH THE SHAMPOO DELIVERY HOSE– FIGS. 23– 24

- Fix the shampoo delivery hose (20) to the vacuum hose (17) using the clips (29) supplied.
- Fix the large plug end of the shampoo delivery hose (20.1) into the shampoo delivery socket (2) located on the front of the motor housing.
- Fix the other end of the shampoo delivery hose with the screw fitting (20.2) onto the shampoo/vacuum control handle grip, as shown in Fig.25.

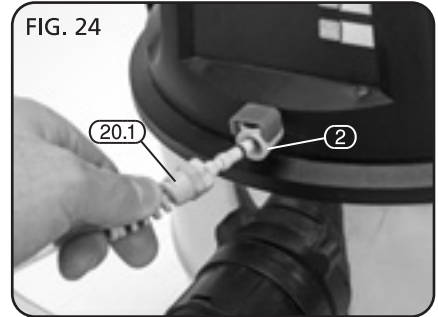
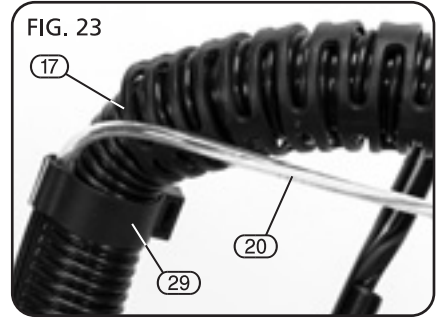

## 11.2 FILL THE SHAMPOO TANK – FIG. 25

- Fill the shampoo tank (11) with as much correctly diluted anti-foam shampoo (Draper Stock No.28801) as required. Always follow the shampoo manufacturer's direction ratios. The shampoo tank has a capacity of approximately 4 litres.
- Fit the shampoo supply tank into its housing on the base of the machine, situated to the rear.

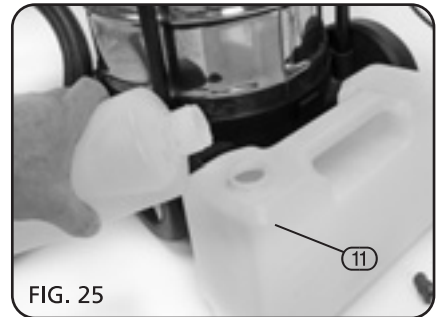

## 11.3 REFIT MOTOR HOUSING – FIG. 26

Place housing on top as shown, then secure using the two tank catches (6).





# 11. INJECTION/EXTRACTION SHAMPOO

## 11.4 CONNECTING SHAMPOO INLET HOSE AND FILTER – FIGS. 27 – 28

- Place the sponge filter end of the shampoo inlet hose (10) into the shampoo tank (11) and push fit the cap (10.1) onto the shampoo tank to close.
- Connect the plastic plug on the other end of the shampoo inlet hose directly into the shampoo delivery inlet socket (10.2) on the side of the motor housing.

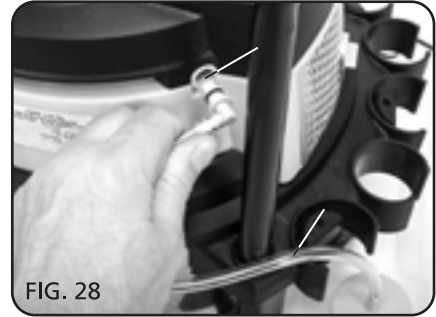
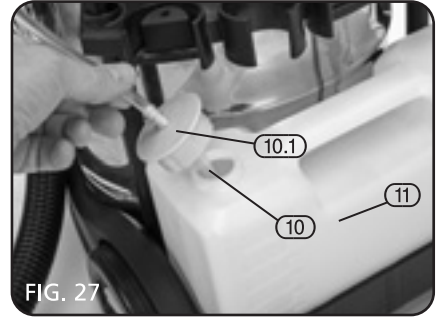

## 11.5 ATTACHING THE LARGE FLUID NOZZLE – FIGS. 29 – 30

- Set up the vacuum cleaner for vacuuming fluids by following the procedures explained on pages 14 – 15.
- If not already fitted, follow the procedure listed above in chapter 11.1 for attaching the main shampoo delivery hose (20) to the flexible vacuum hose (17) plus connections to vacuum cleaner and shampoo/vacuum control handle grip (18).
- Attach the large fluid shampoo delivery hose (23.1) to the large fluid nozzle (23) by slotting the spray end (23.2) into the plastic bracket (23.3) located on the underside of the nozzle.
- Connect the other screw fitting end of large fluid delivery hose (23.4) to the shampoo/vacuum control handle grip (18), as shown in Fig.25.

**Note:** Follow the same procedure above when using the shampoo upholstery attachment.

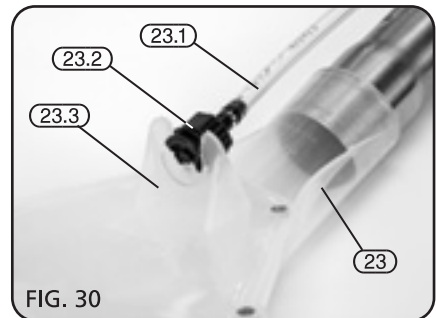
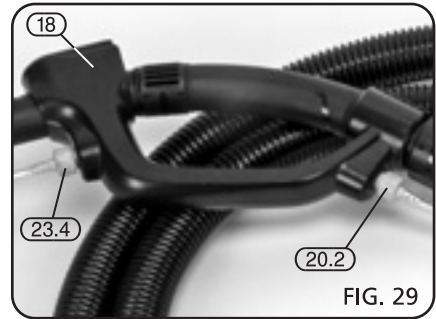

# 11. INJECTION/EXTRACTION SHAMPOO

## 11.6 ATTACHING THE SMALL FLUID NOZZLE – FIG. 31

The small fluid nozzle (22) connects directly onto the shampoo/vacuum control handle grip (18) without need for the retractable extension tube.

- Set up the vacuum cleaner for vacuuming fluids by following the procedures explained on pages 14 – 15.
- If not already fitted, follow the procedure listed in chapter 11.1 for attaching the main shampoo delivery hose (20) to the flexible vacuum hose (17) plus connections to vacuum cleaner and shampoo/vacuum control handle grip (18).
  - If the machine is or has been used in conjunction with the large fluid nozzle (23) and retractable extension tube (19), remove these and also the large fluid shampoo delivery hose (23.1) where it joins the shampoo/vacuum control handle grip by unscrewing and removing the fitting where it joins onto the handle grip.
- Connect up the small fluid shampoo delivery hose (22.1) onto the shampoo/vacuum control handle grip (18) by screwing on the attached fitting (22.2), as shown in Fig.35.

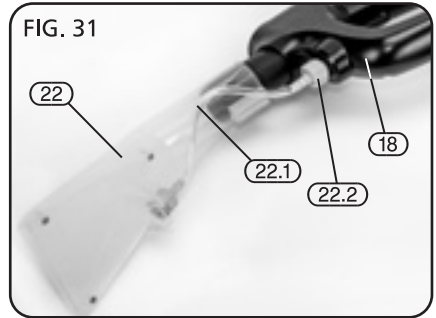

## 11.7 SWITCH ON – FIGS. – 32 – 33

Connect the vacuum cleaner to the power supply and switch the vacuum cleaner 'on' by pushing the power on/off switch (5).

- Use the machine in shampoo mode by pressing the button identified by the symbol below; this can be achieved by pressing the button located on the front of the motor housing (4.2), or preferably by using the shampoo (18.2) and vacuum button (18.1) located on the remote control handle grip (18), making for easier operation when frequently switching between shampoo and vacuum modes.

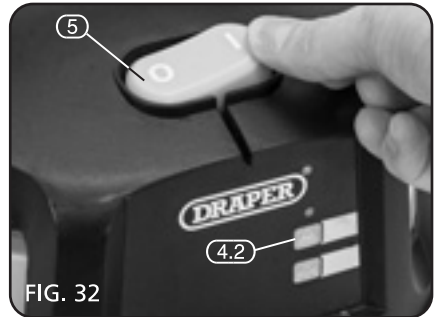

Vacuum cleaning selection.



Shampoo selection.

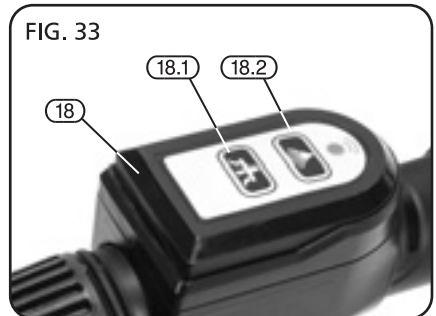

# 11. INJECTION/EXTRACTION SHAMPOO

## 11.8 INJECTION/EXTRACTION CLEANING OF HARD FLOORS – FIG. 34

Use the large fluid nozzle (23).

**Note:** Use rubber sleeve (23.1) for use on hard floors.

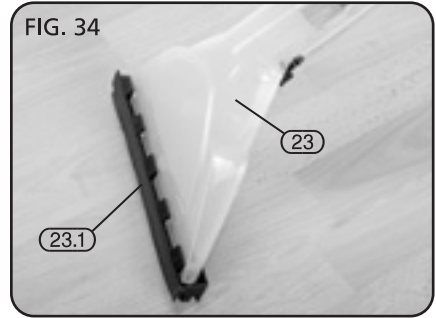

## 11.9 INJECTION/EXTRACTION CLEANING OF CARPETS – FIG. 35

Use the large fluid nozzle (23). Remove the rubber sleeve (23.1).

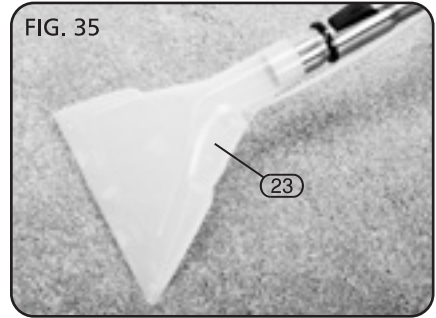

## 11.10 INJECTION/EXTRACTION CLEANING OF UPHOLSTERY – FIG. 36

Remove the large fluid nozzle and fit the small fluid nozzle (22), following the procedures outlined in chapter 11.6 on page 18.

**Note:** Always clean a small hidden piece of carpet/material that you are going to clean to check the fastness of the colour.

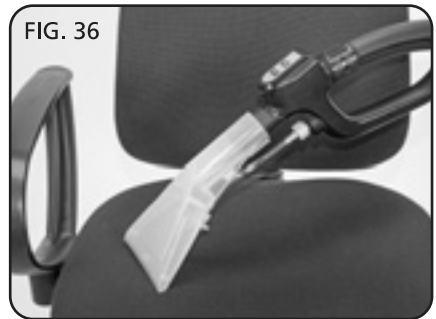

## 12. MAINTENANCE & PARTS REPLACEMENT

Regular inspection and cleaning reduces the necessity for maintenance operations and will keep your tools in good working condition.

The motor must be correctly ventilated during the tools operation. For this reason avoid blocking the air inlets.

If the replacement of the supply cord is necessary, this has to be done by the manufacturer or his agent in order to avoid a safety hazard.

Remove the plug from the socket before carrying out adjustment, servicing or maintenance.

- Empty tank regularly. Never leave fluids in the receptacle as these could damage the material over a period of time.
- After having picked up fluids, dry extension tubes, hose and motor parts by running the vacuum cleaner for a few minutes, **AFTER HAVING EMPTIED THE TANK.**
- Always keep spare dust bags and cartridge filters so that the vacuum cleaner is always ready for use.
- Regularly clean and wash the motor filter located inside the fluid float cage.
- Use of paper dust bags - as suction pressure decreases, replace the paper dustbag with a new one.
- Clean the cartridge filter periodically with a soft brush. This will prolong the life of the filter.

NOTE: The filter must be dry before re-using.

### 12.1 TROUBLESHOOTING GUIDE

| Symptom                                      | Possible causes   | Corrective action  |
|--|---|--|
| Vacuum will not operate.                     | <ol style="list-style-type: none"><li>1. No power supply.</li><li>2. Faulty power cord.</li><li>3. Container full.</li><li>4. Switch in the wrong position.</li></ol>                       | <ol style="list-style-type: none"><li>1. Check power supply, cord, breakers, fuses.</li><li>2. Unplug and check the power cord – if damaged, have it repaired by a professional.</li><li>3. Empty container.</li><li>4. Press the 'on' button on the motor head.</li></ol> |
| Dust comes out from the motor cover.         | <ol style="list-style-type: none"><li>1. The cartridge filter is missing or damaged.</li></ol>  | <ol style="list-style-type: none"><li>1. Attach or replace cartridge filter.</li></ol>   |
| Reduced efficiency and motor/speed vibration | <ol style="list-style-type: none"><li>1. There is a blockage in the nozzle, hose or the container inlet. The cartridge filter is clogged by fine dust.</li><li>2. Container full.</li></ol> | <ol style="list-style-type: none"><li>1. Check nozzle, hose and container inlets for blockage. Take off the filter and clean it, or install new cartridge filter.</li><li>2. Empty container.</li></ol>  |
| Remote control will not operate.             | <ol style="list-style-type: none"><li>1. Battery is dead.</li></ol>   | <ol style="list-style-type: none"><li>1. Replace the battery.</li></ol>  |

## 13. OPTIONAL ACCESSORIES

---

### 13.1 OPTIONAL ACCESSORIES

| Stock No. | Part No. | Description.                     |
|-----------|----------|----------------------------------|
| 83548     | AVC139   | Foam filter.                     |
| 83533     | AVC137   | Cartridge filter.                |
| 83550     | AVC140   | Suction hose.                    |
| 83551     | AVC141   | Stainless telescopic tube.       |
| 83552     | AVC142   | Hose Storage hook.               |
| 83553     | AVC143   | Remote handle.                   |
| 83554     | AVC144   | Shampoo head (large).            |
| 83555     | AVC145   | Shampoo spraying nozzle (large). |
| 83556     | AVC146   | Shampoo head (small).            |
| 83557     | AVC147   | Shampoo spraying nozzle (small). |
| 61009     | AVC130   | Combo floor brush.               |
| 06948     | AVC87    | Round brush.                     |
| 06946     | AVC86    | Crevice tool.                    |
| 83558     | AVC148   | Dust collection bag × 3.         |

# 14. EXPLANATION OF SYMBOLS/PICTOGRAMS

---

## 14.1 EXPLANATION OF SYMBOLS/PICTOGRAMS



Do not dispose of WEEE\*  
as unsorted municipal waste.



For indoor use.  
Do not expose to rain.



Class II construction.  
(Double insulated).

\* Waste Electrical & Electronic Equipment.



**Warning!**  
Read the instruction manual.



# 15. DISPOSAL

---

## 15.1 DISPOSAL

- At the end of the machine's working life, or when it can no longer be repaired, ensure that it is disposed of according to national regulations.
- Contact your local authority for details of collection schemes in your area.

In all circumstances:

- Do not dispose of power tools with domestic waste.
- Do not incinerate.
- Do not abandon in the environment.
- Do not dispose of WEEE\* as unsorted municipal waste.



\* Waste Electrical & Electronic Equipment.

- **DRAPER TOOLS LIMITED,**  
Hursley Road, Chandler's Ford,  
Eastleigh, Hampshire. SO53 1YF. U.K.
- **Helpline:** (023) 8049 4344
- **Sales Desk:** (023) 8049 4333
- **General Enquiries:** (023) 8026 6355
- **Service/Warranty Repair Agent**  
For aftersales servicing or warranty repairs, please contact the Draper Tools Helpline for details of an agent in your local area.

YOUR DRAPER STOCKIST

DKCH1015

