

DRAPER®

INSTRUCTIONS FOR 250W Wet & Dry Bench Grinder

Stock No.78456 Part No.GWD200A

IMPORTANT: PLEASE READ THESE INSTRUCTIONS CAREFULLY TO ENSURE THE SAFE AND EFFECTIVE USE OF THIS PRODUCT.



CE

DRAPER®

GENERAL INFORMATION

Read all these instructions before operating this product and save these instructions.

This manual has been compiled by Draper Tools and is an integrated part of the product with which it is enclosed and should be kept with it for future references.

This manual describes the purpose for which the product has been designed and contains all the necessary information to ensure its correct and safe use. We recommend that this manual is read before any operation or, before performing any kind of adjustment to the product and prior to any maintenance tasks. By following all the general safety instructions contained in this manual, it will ensure both product and operator safety, together with longer life of the product itself.

All photographs and drawings in this manual are supplied by Draper Tools to help illustrate the operation of the product.

Whilst every effort has been made to ensure accuracy of information contained in this manual, the Draper Tools policy of continuous improvement determines the right to make modifications without prior warning.



CONTENTS

Contents/Declaration 1

Specification/Guarantee 2

Power Supply 3

General Safety Instructions 4

Additional Safety Rules for Bench Grinders 5

Getting to Know Your Wet & Dry Bench Grinder 6

Assembly 7

Operation and Use 8

Grinding Tips/Trouble Shooting 9

Optional Accessories 10



DECLARATION OF CONFORMITY

We:
 Draper Tools Ltd.,
 Hursley Road,
 Chandler's Ford,
 Eastleigh, Hampshire.
 SO53 1YF.
 England.

Declare under our sole responsibility that the product:

Stock No:- **78456.**
 Part No:- **GWD200A.**
 Description:- **Wet & Dry Bench Grinder.**

To which this declaration relates is in conformity with the following directive(s)
 98/37/EC & 89/336/EEC

With reference to:
 EN60129:2000, prEN61029-2-4:1992



J.N. Draper
 Chairman

23/06/2004



SPECIFICATION

The Draper Tools policy of continuous improvement determines the right to change specification without notice.

Stock No.	78456
Part No.	GWD200A
Rated Voltage	230V~50Hz
Rated Input	250W
Speed	
Grinding Wheel	2950min ⁻¹
Whetstone	134min ⁻¹
Wheel Dimension	
Grinding Wheel	150mmØ x 12.7mm bore
Whetstone	200mmØ x 20mm bore
Weight	10kg

ALWAYS WEAR SAFETY GOGGLES AND EAR DEFENDERS



GUARANTEE

Draper tools have been carefully tested and inspected before shipment and are guaranteed to be free from defective materials and workmanship.

Should the tool develop a fault, please return the complete tool to your nearest distributor or contact Draper Tools Limited, Chandler's Ford, Eastleigh, Hampshire, SO53 1YF England. Telephone: (023) 8026 6355.

A proof of purchase must be provided with the tool.

If upon inspection it is found that the fault occurring is due to defective materials or workmanship, repairs will be carried out free of charge. This guarantee period covering parts/labour is 12 months from the date of purchase. The guarantee is extended to 24 months for parts only. This guarantee does not apply to normal wear and tear, nor does it cover any damage caused by misuse, careless or unsafe handling, alterations, accidents, or repairs attempted or made by any personnel other than the authorised Draper warranty repair agent.

Note: If the tool is found not to be within the terms of warranty, repairs and carriage charges will be quoted and made accordingly.







This guarantee applies in lieu of any other guarantee expressed or implied and variations of its terms are not authorised.

Your Draper guarantee is not effective unless you can produce upon request a dated receipt or invoice to verify your proof of purchase within the guarantee period.

Please note that this guarantee is an additional benefit and does not affect your statutory rights.

Draper Tools Limited.

- Connecting to the Power Supply:

To eliminate the possibility of an electric shock your machine has been fitted with a BS approved, non rewirable moulded plug and cable which incorporates a fuse, the value of which is indicated on the pin face of the plug. If the plug is marked with the  symbol and the fuse needs replacing, an  approved BS1362 fuse must be used of the same amp rating. If the plug is not  marked, a fuse with the  symbol,  BS Kitemark, or both  and  BS Kitemark, of the same amp rating should be used.

- The fuse cover is detachable, never use the plug with the cover omitted. If a replacement fuse cover is required, ensure it is the same colour as that visible on the pin face of the plug (i.e. red). Fuse covers are available from your Draper Tools stockist.

If the fitted plug is not suitable, it should be cut off and destroyed. *The end of the cable should now be suitably prepared and the correct type of plug fitted. See below.

- *WARNING:

A plug with bare flexible wires exposed is hazardous if engaged in a live power socket outlet.

- WARNING: THIS APPLIANCE MUST BE EARTHED.

- The mains lead is coloured Green and Yellow – Earth, Blue – Neutral and Brown – Live.
- As these colours may not correspond with the coloured markings identifying the terminals in your plug, proceed as follows:

The wire which is coloured green and yellow must be connected to the terminal in your plug which is marked with the letter 'E' or by the earth symbol  or coloured green or green and yellow.

The wire which is coloured blue must be connected to the terminal which is marked with the letter 'N' or coloured black or blue.

The wire which is coloured brown must be connected to the terminal which is marked with the letter 'L' or coloured red or brown.

- EXTENSION LEAD CHART:

Extension lead sizes shown assure a voltage drop of not more than 5% at rated load of tool.

Ampere rating (on Name plate)	3	6	10	13
Extension cable length (Metres)	Wire Size mm ²			
7.5	0.75	0.75	1.0	1.25
15	0.75	0.75	1.0	1.5
22.5	0.75	0.75	1.0	1.5
30	0.75	0.75	1.25	1.5
40	0.75	0.75	1.5	2.5

IMPORTANT:

On products exceeding 2000W it is recommended that the power cable and/or extension cable are fully unwound before a connection is made to the power supply. However, ensure the residual cable does not pose a trip hazard.

WARNING:

Please read the following instructions carefully, failure to do so could lead to serious personal injury. When using electric tools, basic safety precautions, including the following, should always be followed to reduce the risk of fire, electric shock and personal injury. Read all these instructions before operating this product and save these instructions.

IMPORTANT:

Draper Tools Limited recommends that this machine should not be modified or used for any application other than that for which it was designed. If you are unsure of its relative applications do not hesitate to contact us in writing and we will advise you.

1. KNOW YOUR POWER TOOL:

Read and understand the owner's manual and labels affixed to the tool. Learn its application and limitations as well as the specific potential hazards peculiar to this tool.

2. KEEP WORK AREA CLEAN:

Cluttered areas and benches invite accidents. Floors must not be slippery due to oil or sawdust.

3. AVOID DANGEROUS ENVIRONMENTS:

Do not use power tools in damp or wet locations, or expose them to rain. Keep work area well lit. Provide adequate space surrounding the work area. Do not use in environments with a potentially explosive atmosphere.

4. KEEP CHILDREN AWAY:

All visitors should be kept a safe distance from work area.

5. STORED TOOLS:

When not being used, all tools should be stored in a dry, locked cupboard and out of the reach of children.

6. WEAR PROPER CLOTHING:

Do not wear loose clothing, neckties or jewellery (rings, wristwatches) to catch in moving parts. NONSLIP footwear is recommended. Wear protective hair covering to contain long hair. Roll long sleeves above the elbow.

7. USE SAFETY GOGGLES (Head Protection):

Wear CE approved safety goggles at all times. Normal spectacles only have impact resistant lenses, they are NOT safety glasses. Also, use face or dust mask if application is dusty and ear protectors (plugs or muffs) during extended periods of operation.

8. NOISE LEVELS:

Some types of machines may have high noise levels when working. In such cases ear protection must be worn.

9. VIBRATION LEVELS:

Hand held power tools produce different vibration levels. You should always refer to the specifications and relevant Health and Safety guide.

10. DUST EXTRACTION:

If your tool is fitted with a dust extraction fitting, always ensure that it is connected and being used with a dust extractor. Vacuum cleaners can be used if suitable for the material being extracted.

11. PROTECT YOURSELF FROM ELECTRIC SHOCK:

When working with power tools, avoid contact with any earthed items (e.g. pipes, radiators, hobs and refrigerators, etc.). If you are using a power tool in extreme conditions (e.g. high humidity or generating metal dust), always use an RCD (residual current device) at the power socket.

12. STAY ALERT:

Always watch what you are doing and use common sense. Do not operate a power tool when you are tired or under the influence of alcohol or drugs.

13. WHEN WORKING OUT OF DOORS:

Only use extension leads designed for that purpose.

14. ACCESS TO MAINS SOCKET:

If a stationary machine is fitted with a moulded plug and cable, the machine should not be positioned so that access to the mains socket is restricted.

15. DISCONNECT POWER TO THE TOOL:

When not in use, before servicing and when changing accessories such as cutters, etc.

16. AVOID ACCIDENTAL STARTING:

Make sure the switch is in the OFF position before plugging the machine into the power supply.

17. NEVER LEAVE MACHINE RUNNING UNATTENDED:

Turn power off. Do not leave machine until it comes to a complete stop.

18. DO NOT ABUSE THE CORD:

Never carry the tool by the power cable or pull it from the socket. Keep the power cable away from heat, oil and sharp edges. If the supply cord is damaged, it must be replaced by the manufacturer or its service agent or a similarly qualified person in order to avoid hazard.

19. NEVER STAND ON TOOL:

Serious injury could occur if the tool is tipped or if the cutting tool is accidentally contacted. Do not store materials above or near the tool, so that it is necessary to stand on the tool to reach them.

20. CHECK DAMAGED PARTS:

Before further use of the tool, a guard or other part that is damaged should be carefully checked to determine that it will operate properly and perform its intended function. Check for alignment of moving parts, free running of moving parts, breakage of parts, mounting and any other conditions that may affect its operation. A guard or other part that is damaged should be repaired properly or replaced by an authorized service centre unless otherwise indicated in this instruction manual. Have defective switches replaced by an authorized service facility. Do not use the tool if the switch does not turn it on and off.

21. KEEP GUARDS IN PLACE:

And in working order.

22. MAINTAIN TOOLS WITH CARE:

Keep tools sharp and clean for the best and safest performance. Follow instructions for lubricating and changing accessories. All extension cables must be checked at regular intervals and replaced if damaged. Always keep the hand grips on the tool clean, dry and free of oil and grease.

23. USE RECOMMENDED ACCESSORIES:

Consult the owners manual for recommended accessories. Follow the instructions that accompany the accessories. The use of improper accessories may cause hazards.

24. REMOVE ADJUSTING KEYS AND WRENCHES:

Form a habit of checking to see that keys and adjusting wrenches are removed from the tool before turning it on.

25. SECURE WORK:

Use clamps or a vice to hold work. This frees both hands to operate the tool.

26. DO NOT OVERREACH:

Keep proper footing and balance at all times.

27. USE RIGHT TOOL:

Do not force the tool or attachment to do a job for which it was not designed.

28. DO NOT FORCE TOOL:

It will do the job better and safer at the rate for which it was designed.

29. DIRECTION OF FEED:

Feed work into a blade or cutter against the direction of rotation of the blade or cutter only.

30. WHEN DRILLING OR SCREWING INTO WALLS:

Always make sure there is no danger of hitting any hidden power cables, water or gas pipes in the wall.

31. HAVE YOUR TOOL REPAIRED BY A QUALIFIED PERSON:

This electric tool is in accordance with the relevant safety requirements. Repairs should only be carried out by qualified persons using original spare parts, otherwise this may result in considerable danger to the user.

IMPORTANT NOTE:

Residual Risk. Although the safety instructions and operating manuals for our tools contain extensive instructions on safe working with power tools, every power tool involves a certain residual risk which can not be completely excluded by safety mechanisms. Power tools must therefore always be operated with caution!

- **WARNING:**
FOR YOUR OWN SAFETY READ AND UNDERSTAND THIS INSTRUCTION MANUAL BEFORE USE
- **Always** wear eye protection which complies to a recognised standard.
- Wear a mask or respirator when dust is generated.
- Tighten grinding wheel lock nuts, securing bolts and all clamps and guards.
- Keep guards in place and working properly.
- Keep hands clear of grinding wheels.
- **Never** reach behind or beneath the grinding wheels.
- Unplug from power supply before adjusting or servicing. The grinding wheels continue to rotate after the tool is switched off. **Always** allow wheels to stop before adjusting or servicing.
- To avoid electric shock, **DO NOT** use in damp conditions or expose to rain.
- When fitting a new grinding wheel, **Always** check that the stated maximum rpm exceeds that stated on the grinder. Also check the new wheel for damage such as flaws or cracks. If the wheel appears satisfactory, fit it to the grinder.
- When a new grinding wheel has been fitted, stand to one side of the grinder and switch 'On'. Let the grinder operate at full speed for approximately one minute so that any undetected flaws or cracks will become apparent.
- **DO NOT** attempt to cut anything with the grinding wheel.
- **ENSURE** work area is free from flammable materials.

GETTING TO KNOW YOUR WET & DRY BENCH GRINDER

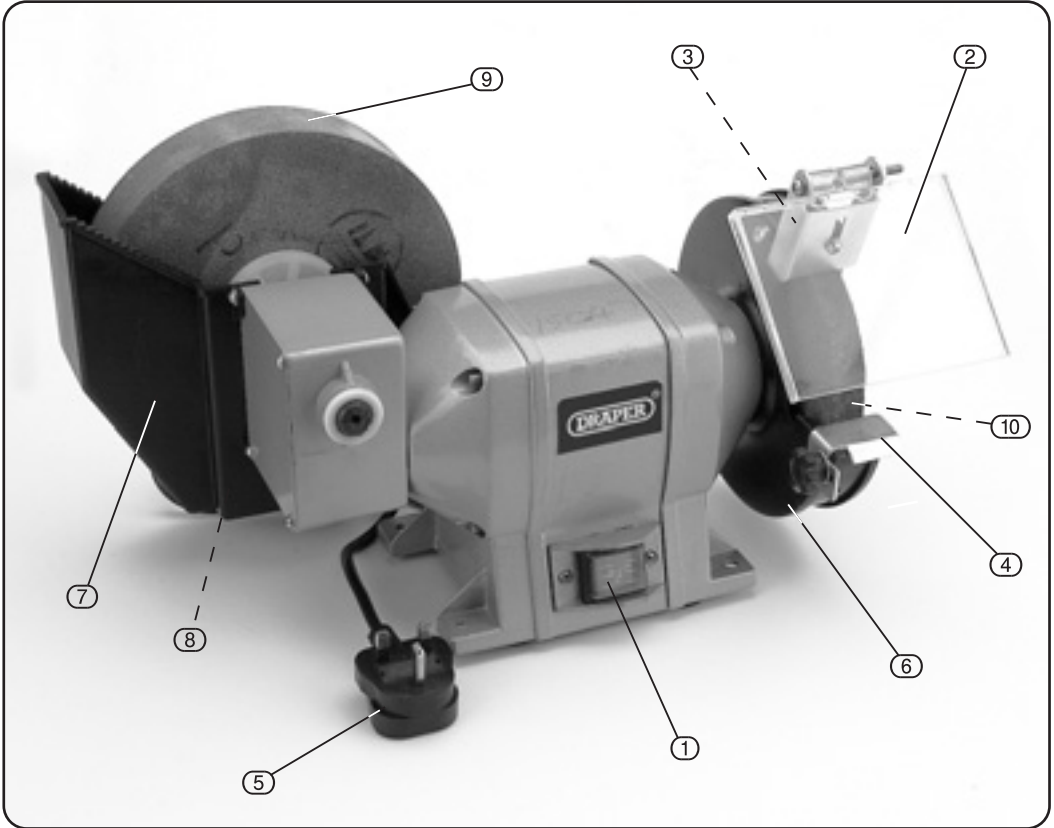

- | | |
|------------------------------|-------------------|
| ① On/Off Rocker Switch. | ⑥ Wheel Guard. |
| ② Eye Shield. | ⑦ Reservoir. |
| ③ Spark Deflector. | ⑧ Drain Bung. |
| ④ Tool Rest. | ⑨ Whetstone. |
| ⑤ BS Moulded Plug and Cable. | ⑩ Grinding Wheel. |

- **UNPACKING:** After removing the packing material, make sure the product is in perfect condition and that there are no visible damaged parts. If in doubt, do not use the product and contact the dealer from whom it was purchased.

The packaging materials (plastic bags, polystyrene, etc.), must be disposed of in an appropriate refuse collection container. These materials must not be left within the reach of children as they are potential sources of danger.

- **NOTE:** Remove the plug from the socket before carrying out adjustment, servicing or maintenance.

- **SPARK DEFLECTOR (Fig.1):**

Fit the spark deflector/eye shield (A) to the wheel guard using the screw provided. Adjust it so that there is approximately 1.5mm gap between the face of the grinding wheel and the edge of the spark deflector

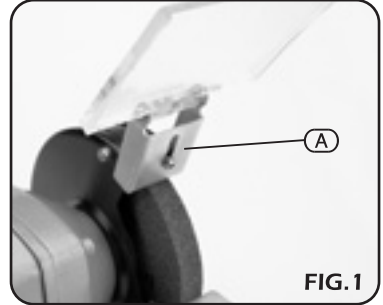

- **TOOL REST (Fig.2):**

Fit the tool rest (B) to the inner edge of the wheel guard using locking knob (C) on bolt (D). Adjust it so there is approx. 1.5mm between the grinding wheel face and the tool rest.

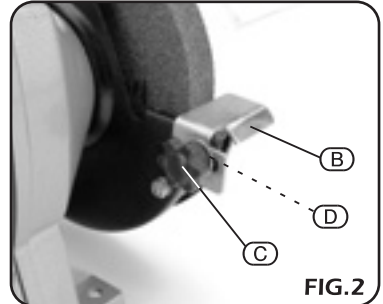

- **EYE SHIELD (Fig.3):**

Select the required position and tighten the nut and bolt (D).

- **NOTE:** Do not overtighten the nut as this may crack the shield.

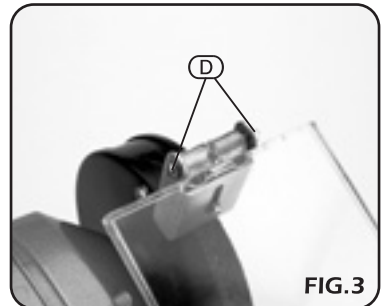

- **BENCH MOUNTING YOUR GRINDER (Fig.4):**

Securely bolt the wet and dry bench grinder to a work bench or other secure surface through the various points in the base (fixings are not supplied). Ensure there is enough clear space around the grinder to accommodate large items which may be ground, ie. garden tools, etc. To reduce any vibration, mount the grinder on a vibration absorption mat.



- **Note:** Remove the plug from the socket before carrying out adjustment, servicing or maintenance.

- **REPLACING THE GRINDING WHEEL (Fig.5):**

Loosen the screws and nuts holding the wheel guard (E) and remove. Hold the wheel by hand, and remove the locking nut and flange. Slide off the old grinding wheel.

When fitting a new grinding wheel, always check that the stated max. RPM on the wheel exceeds the RPM of the bench grinder. Inspect the new wheel for any damage, such as flaws or cracks. If the wheel appears satisfactory, fit it to the grinder.

Replace the flange and locking nut then tighten. A "shock" type method may be required to tighten the nut fully. **DO NOT** overtighten to avoid damage to the wheel.

Re-assemble the cover and when stood to one side, switch the grinder on to run the wheel up. Let the grinder operate at full speed for approximately one minute so that any undetected cracks or flaws in the wheel will become apparent.

- **REPLACING THE WHETSTONE (Fig.6):**

Empty the reservoir (E) first by removing the bung (G). When the water is completely drained out remove the two screws (H). Position the grinder to access the underside. Remove the screw on the underside and slide the reservoir out. Hold the grinding wheel and remove the nut (J) anticlockwise. Remove flange (K) and replace the whetstone.

Inspect the new wheel for any damage, such as flaws or cracks. If the wheel appears satisfactory, fit it to the grinder.

- **GRINDING / HONING (Fig.7):**

The technique to adopt when honing is to hold the item against the upside of the whetstone and standing on the left hand side of the machine. Ensure the reservoir is kept topped up. **DO NOT** hone on a dry whetstone.

A bench grinder is designed for hand grinding operations only, such as sharpening drill bits, chisels and screwdrivers or removing excess metal from work pieces.

A coarse grit grinding wheel could be used for rough metals, to remove large amounts of metal or where a smooth finish is not important.

A fine grit grinding wheel could be used for sharpening tools or grinding close to size. A fine grit wheel removes metal more slowly and therefore gives the work piece a smooth finish and does not generate enough heat to anneal the cutting edges.

Check that there is a 1.5mm clearance between the tool rests and the surface of the grinding wheel. Adjust as necessary. Now check the gap between the spark deflectors and the surface the grinding wheel. These should also be 1.5mm. Adjust as necessary.

Check that the eye shields have been secured in the correct position and that the grinding wheel lock nuts are tight.

When grinding, always keep the work piece moving across the face of the wheel. Grinding against the same part of the wheel will cause uneven wear of the wheel face.

When necessary, re-dress the grinding wheels using a wheel dressing tool. After re-dressing, adjust the tool rests and spark deflectors as necessary to maintain a 1.5mm clearance from the wheel.

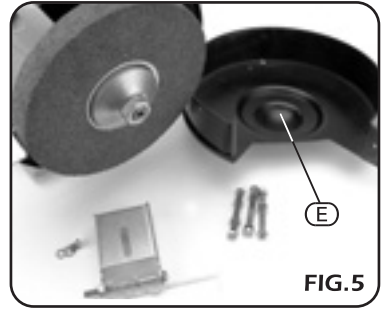

FIG.5

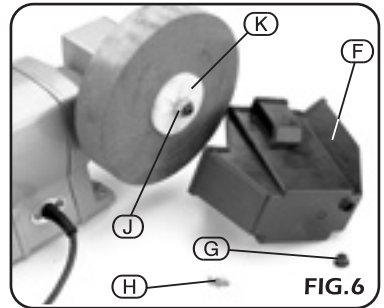

FIG.6

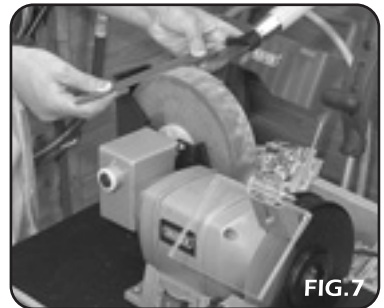

FIG.7

GRINDING TIPS

- Ensure that the item to be ground is comfortably and securely held.
- Adjust tool rest to correct angle.
- Present the work piece smoothly onto the grinding wheel face with a light and even pressure.
- Grind against the edge of the work piece to avoid burrs.
- Never grind on the sides of the wheels.
- Best results are achieved if the grinder is allowed to rotate at its maximum speed. Excess pressure from the work piece can damage the wheel and overload the motor.
- Check grinding wheels regularly for wear or damage. Replace wheels that are worn more than 25%. Damaged wheels should be discarded immediately as they are dangerous and can cause the grinder to vibrate.
- After grinding fine edge tools, the tool should be honed by hand on a fine slip stone.

TROUBLE SHOOTING

WARNING:

For your own safety, always turn the main switch on the machine "Off" and remove the plug from the power supply before carrying out any servicing or maintenance.

TROUBLE	PROBABLE CAUSE	REMEDY
Machine will not start.	<ol style="list-style-type: none"> 1. Fuse. 2. Jammed wheel. 3. Other. 	<ol style="list-style-type: none"> 1. 13amp time delay fuse or circuit breaker. 2. Check for obstruction and remove. 3. Authorised service agent.
Machine vibrates.	<ol style="list-style-type: none"> 1. Wheel out of balance. 2. Wheel loose. 3. Damaged wheel (consumable item). 	<ol style="list-style-type: none"> 1. Dress wheel or replace. 2. Tighten wheel. 3. Replace wheel (consumable item).

GRINDING WHEELS:

Stock No.	Diameter	Bore	Type
29629	150mm	12.7mm	Fine grit for general use.
29630	150mm	12.7mm	Course grit for general use.
36298	150mm	12.7mm	Green grit for T.C.T. tool sharpening.
52398	150mm	12.7mm	White grit for H.S.S. steel.

WHETSTONE WHEELS:

Stock No.	Diameter	Bore	Type
79016	200mm	20mm	General purpose whetstone.

STEEL WHEEL:

Stock No.	Diameter	Bore	Type
33879	150mm	50mm*	Crimped steel wire wheel.

* Reducing bushes supplied.

- At the end of the machine's working life, or when it can no longer be repaired, ensure that it is disposed of according to UK regulations.
- Contact your local authority for details of collection schemes in your area.

In all circumstances:

- Do not dispose of power tools with domestic waste.
- Do not incinerate.
- Do not abandon in the environment.
- Do not dispose of WEEE* as unsorted municipal waste.



* Waste Electrical & Electronic Equipment.

- **DRAPER TOOLS LIMITED,**
Hursley Road, Chandler's Ford,
Eastleigh, Hampshire. SO53 1YF. U.K.

- **Helpline:** (023) 8049 4344
- **Sales Desk:** (023) 8049 4333
- **General Enquiries:** (023) 8026 6355
- **Fax:** (023) 8026 0784
- **Internet:** www.draper.co.uk
- **E-mail:** sales@drapertools.com

- **Service/Warranty Repair Agent**
For aftersales servicing or warranty repairs, please contact the Draper Tools Helpline for details of an agent in your local area.

YOUR DRAPER STOCKIST

OAKC010307

©Published by Draper Tools Limited.

No part of this publication may be reproduced, stored in a retrieval system or transmitted in any form or by any means, electronic, mechanical photocopying, recording or otherwise without prior permission in writing from Draper Tools Ltd.