

# DRAPER<sup>®</sup>

## INSTRUCTIONS FOR 2.0kVA/1.6kW Petrol Inverter Generator

Stock No.80956 Part No.DGI2000

**MACHINE SHIPPED WITH NO OIL, ADD OIL BEFORE TRYING TO START THIS MACHINE.**

**IMPORTANT:** PLEASE READ THESE INSTRUCTIONS CAREFULLY TO ENSURE THE SAFE AND EFFECTIVE USE OF THIS PRODUCT.



CE

DRAPER<sup>®</sup>

### GENERAL INFORMATION

These instructions accompanying the product are the original instructions. This document is part of the product, keep it for the life of the product passing it on to any subsequent holder of the product. Read all these instructions before assembling, operating or maintaining this product.

This manual has been compiled by Draper Tools describing the purpose for which the product has been designed, and contains all the necessary information to ensure its correct and safe use. By following all the general safety instructions contained in this manual, it will ensure both product and operator safety, together with longer life of the product itself. All photographs and drawings in this manual are supplied by Draper Tools to help illustrate the operation of the product. Whilst every effort has been made to ensure the accuracy of information contained in this manual, the Draper Tools policy of continuous improvement determines the right to make modifications without prior warning.

# 1. TITLE PAGE

---

## **1.1 INTRODUCTION:**

USER MANUAL FOR:

## **2.0kVA/1.6kW PETROL INVERTER GENERATOR**

Stock no. 80956

Part no. DGI2000

## **1.2 REVISIONS:**

---

Date first published May 2015.

---

---

---

As our user manuals are continually updated, users should make sure that they use the very latest version.

Downloads are available from: <http://www.drapertools.com/b2c/b2cmanuals.pgm>

DRAPER TOOLS LIMITED

HURSLEY ROAD

CHANDLER'S FORD

EASTLEIGH

HAMPSHIRE

SO53 1YF

UK

WEBSITE:

drapertools.com

PRODUCT HELPLINE:

+44 (0) 23 8049 4344

GENERAL FAX:

+44 (0) 23 8026 0784

## **1.3 UNDERSTANDING THIS MANUALS SAFETY CONTENT:**

**WARNING!** Information that draws attention to the risk of injury or death.

**CAUTION!** Information that draws attention to the risk of damage to the product or surroundings.

**NOTE!** Important information.

## **1.4 COPYRIGHT © NOTICE:**

Copyright © Draper Tools Limited.

Permission is granted to reproduce this publication for personal & educational use only.

Commercial copying, redistribution, hiring or lending is prohibited.

No part of this publication may be stored in a retrieval system or transmitted in any other form or means without written permission from Draper Tools Limited.

In all cases this copyright notice must remain intact.

---

# 2. CONTENTS

---

## 2.1 CONTENTS

<b>PAGE</b>	<b>CONTENT</b>	<b>PAGE</b>
1	TITLE PAGE	
	1.1 INTRODUCTION .....	2
	1.2 REVISION HISTORY .....	2
	1.3 UNDERSTANDING THIS MANUAL .....	2
	1.4 COPYRIGHT NOTICE .....	2
2	CONTENTS	
	2.1 CONTENTS .....	3
3	GUARANTEE	
	3.1 GUARANTEE .....	4
4.	INTRODUCTION	
	4.1 SCOPE.....	5
	4.2 SPECIFICATION .....	5
	4.3 HANDLING & STORAGE .....	5
	4.4 HANDLING & STORAGE .....	6
5.	HEALTH & SAFETY INFORMATION	
	5.1 GENERAL SAFETY INSTRUCTIONS FOR GENERATOR USE .....	7-8
6.	TECHNICAL DESCRIPTION	
	6.1 IDENTIFICATION .....	9
	6.2 MAIN COMPONENT DESCRIPTIONS .....	10
7.	UNPACKING & CHECKING	
	7.1 PACKAGING.....	11
	7.2 WHAT'S IN THE BOX? .....	11
8.	PREPARING THE GENERATOR	
	8.1 ADDING ENGINE OIL .....	12
	8.2 ADDING FUEL .....	12-13
	8.3 BEFORE OPERATION .....	13
	8.4 BEFORE EACH USE:- PRE-OPERATION CHECK.....	14
9.	STARTING/STOPPING THE GENERATOR	
	9.1 STARTING THE GENERATOR .....	15
	9.2 STOPPING THE GENERATOR .....	16
10.	USING THE GENERATOR	
	10.1 CONTROL PANEL .....	17-18
	10.2 AC APPLICATIONS .....	19
	10.3 AC APPLICATIONS AND OPERATION .....	20
	10.4 DC OPERATION.....	21-22
	10.5 DISCONNECTING THE BATTERY CHARGING CABLE .....	22
11.	MAINTENANCE	
	11.1 THE IMPORTANCE OF MAINTENANCE.....	23
	11.2 MAINTENANCE SAFETY .....	23
	11.3 MAINTENANCE SCHEDULE .....	24
	11.4 ENGINE OIL CHANGE .....	24
	11.5 AIR CLEANER SERVICE.....	25
	11.6 SPARK PLUG SERVICE.....	26
12.	TROUBLESHOOTING	
	12.1 ENGINE WILL NOT START .....	27
	12.2 ENGINE STARTS BUT GENERATOR DOES NOT OPERATE .....	27
13.	EXPLANATION OF SYMBOLS	
	13.1 EXPLANATION OF SYMBOLS .....	29
	DECLARATION OF CONFORMITY .....	ENCLOSED

## 3. GUARANTEE

---

### 3.1 GUARANTEE

Draper tools have been carefully tested and inspected before shipment and are guaranteed to be free from defective materials and workmanship.

Should the tool develop a fault, please return the complete tool to your nearest distributor or contact Draper Tools Limited, Chandler's Ford, Eastleigh, Hampshire, SO53 1YF. England. Telephone Sales Desk: (023) 8049 4333 or Product Helpline (023) 8049 4344.

A proof of purchase must be provided with the tool.

If upon inspection it is found that the fault occurring is due to defective materials or workmanship, repairs will be carried out free of charge. This guarantee period covering parts/labour is 12 months from the date of purchase except where tools are hired out when the guarantee period is ninety days from the date of purchase. The guarantee is extended to 24 months for parts only. This guarantee does not apply to normal wear and tear, nor does it cover any damage caused by misuse, careless or unsafe handling, alterations, accidents, or repairs attempted or made by any personnel other than the authorised Draper warranty repair agent.

Note: If the tool is found not to be within the terms of warranty, repairs and carriage charges will be quoted and made accordingly.

This guarantee applies in lieu of any other guarantee expressed or implied and variations of its terms are not authorised.

Your Draper guarantee is not effective unless you can produce upon request a dated receipt or invoice to verify your proof of purchase within the guarantee period.

Please note that this guarantee is an additional benefit and does not affect your statutory rights.

Draper Tools Limited.

## 4. INTRODUCTION

---

### 4.1 SCOPE

Inverter generator with pure sine wave, suitable for powering TV's and other sensitive equipment. Low noise and inverter technology.

### 4.2 SPECIFICATION

Stock no .....	80956
Part no .....	DGI2000
Engine type.....	4 stroke overhead valve single cylinder
Displacement.....	99cc
Compression ratio .....	8.5
Inverter type.....	IGBT
Rated power (MAX.).....	2.0kW@4500rpm (MAX.)
Effective rated power .....	1.6kW
Cooling system .....	Forced air
Power control output .....	Inverter technology
Ignition system .....	C.D.I.
Output sockets .....	2 x 230V AC 1 x 12V DC
Sine wave type .....	PURE
Oil capacity.....	0.75L
Fuel tank capacity .....	4.1L
Sound pressure level.....	60dB(A)@7M
Starting system.....	Recoil
Engine oil.....	SAE 10W 30 (above SJ Grade)
Dimensions .....	555mm x 315mm x 490mm
Weight.....	18.5kg (NETT)

### 4.3 HANDLING & STORAGE

**CAUTION:** Always use and store this generator correctly, never use or store this generator on it's side as oil or fuel may leak and damage the generator or your property.

If the generator has been used always allow it to cool for at least 30 minutes before transporting the generator and ensure that the generator has fully cooled before returning it to storage as a hot engine and exhaust system could cause personal injury or ignite some materials.

To prevent fuel/oil spillage when transporting, the generator should be secured upright in it's normal operating position with the engine switch in the off position.

Take care not to drop or strike the generator when transporting. Never cover the generator when in use.

Before starting the generator for a long period:-

1. Be sure that the storage area is free of excessive humidity and dust.
2. Drain the fuel, storage procedure below.
  - A. Unscrew the fuel tank cap, remove the filter screen and empty the fuel tank into an approved petrol container using a commercially available hand siphon (Draper Stock No.43650), re-install the filter screen and fuel tank cap.
  - B. Loosen the carburettor drain screw and drain the carburettor into a suitable container.
  - C. Remove the spark plug maintenance cover and remove the spark plug cap.
  - D. Turn the engine switch to the OFF position.
  - E. Pull the starter cord 3 or 4 times to empty the fuel pump of petrol, into a suitable container.
  - F. Tighten the carburettor drain screw.

## 4. INTRODUCTION

### 4.4 HANDLING & STORAGE - FIGS.1 - 2

**CAUTION:** Petrol is highly flammable and explosive.

You can be burned or seriously injured when handling fuel.

- Keep heat, sparks and flame away.
  - Handle fuel outdoors only.
  - Wipe up spills immediately.
1. If storing this machine for a prolonged time there are some procedures to follow to prepare the machine prior to storage.
  2. Remove any fuel from the fuel tank by using a siphon (Fig.1.). Held loosen the carburettor drain screw (Fig.2.) and drain remaining fuel into a suitable container prior to correct disposal of old fuel (check local regulations).
  3. Check the machine over and repair or replace any worn or damaged parts.
  4. Remove the spark plug and pour about a tablespoon of clean engine oil into the cylinder. Crank the engine several revolutions to distribute the oil, then re-install the spark plug.
  5. Re-install the spark plug cap on the spark plug securely.
  6. Re-install the spark plug maintenance cover.
  7. Re-install the left side maintenance cover and tighten the cover screw securely.
  8. Pull the starter grip slowly until you feel resistance, then return the starter grip gently.

This closes the valves so moisture cannot enter.

FIG. 1



FIG. 2



# 5. HEALTH & SAFETY INFORMATION

---

## 5.1 GENERAL SAFETY INSTRUCTIONS FOR GENERATOR USE

NOTE: Generators are designed to give safe and dependable service if operated according to instructions. Read and understand this owners manual fully before operating this generator. You can help prevent accidents by being familiar with the generators controls and by observing safe operating procedures.

### OPERATOR RESPONSIBILITY

- Know how to stop the generator quickly in case of emergency.
- Understand the use of all the generators controls, output sockets and connections.
- Be sure that anyone who operates the generator receives proper instruction in it's safe use.

### WARNING!:

#### CARBON MONOXIDE HAZARDS

- Exhaust gases contain poisonous carbon monoxide, a colourless and odourless gas. Breathing carbon monoxide can cause loss of consciousness and may lead to death.
- NEVER** run this generator in an enclosed space or partly enclosed space.

**ALWAYS** ensure a high level of ventilation in the area that you intend to use the generator to avoid the potential build up of carbon monoxide.

### WARNING!:

#### ELECTRIC SHOCK HAZARDS

- The generator produces enough electric power to cause a serious shock or electrocution if misused.
- Using a generator or electrical appliance in wet conditions, such as rain or snow, or near a pool or sprinkler system, or when your hands are wet, could result in electrocution. Keep the generator dry.
- If the generator is stored outdoors, unprotected from the weather, check all of the electrical components on the control panel before each use. Moisture or ice can cause a malfunction or short circuit in electrical components which could result in electrocution.
- Do not connect to a building electrical system unless an isolation switch has been installed by a qualified electrician.
- Never connect different generator models and types.
- Always earth the generator with a ground spike before use.

### WARNING!:

#### FIRE AND BURN HAZARDS

- The exhaust system gets hot enough to ignite some materials.
  - Keep the generator at least 3 feet (1 metre) away from buildings and other equipment during operation.
  - Do not enclose the generator in any structure.
  - Keep flammable materials away from the generator.
- The muffler becomes very hot during operation and remains hot for a while after stopping the engine. Be careful not to touch the muffler while it is hot. Let the engine cool before storing the generator indoors.
- Petrol is extremely flammable and is explosive under certain conditions. Do not smoke or allow flames or sparks where the generator is refuelled or where petrol is stored. Refuel in a well-ventilated area with the engine stopped.
- Fuel vapours are extremely flammable and may ignite after the engine has started. Make sure that any spilled fuel has been wiped up before starting the generator.

## 5. HEALTH & SAFETY INFORMATION

---

### **WARNING!:**

#### **DO NOT OPERATE THIS MACHINE IN ANY HAZARDOUS LOCATION**

Such areas include when there is a risk of an explosion of petrol fumes, leaking gas or explosive dust.

### **CAUTION:**

#### **ENGINE SPEED HAS BEEN FACTORY SET TO PROVIDE SAFE OPERATION**

Tampering with the engine speed adjustment could result in overheating of attachments and could cause a fire. Never attempt to "speed up" the engine to gain more performance as this will result in the output voltage and frequency being thrown out of their standard values, endangering the user and any attachments plugged into the generator.

#### **YOU MUST UNPLUG ANY LOAD FROM THE GENERATOR BEFORE STARTING/STOPPING THE GENERATOR TO PREVENT PERMANENT DAMAGE TO APPLIANCES.**

Ground (Earth) your generator. Ensure that the generator has been grounded by wiring an earth lead, connect one end of the earth lead to the earth terminal on the generator and the other end should be pressed into the ground or used in conjunction with an earth spike.

### **NOTE:**

#### **PROTECT YOUR GENERATOR**

This generator is NOT WEATHERPROOF and should not be exposed to direct sunlight, high ambient temperatures and damp, wet or high humidity conditions.



# 6. TECHNICAL DESCRIPTION

## 6.1 IDENTIFICATION



- ① Fuel cap.
- ② Spark plug cover.
- ③ Choke lever.
- ④ Pull start.
- ⑤ Engine On/off switch.
- ⑥ Exhaust.
- ⑦ 12V DC outlet.
- ⑧ Indicator LEDs.
- ⑨ Throttle switch.
- ⑩ Earth point.
- ⑪ 230V AC outlets.
- ⑫ Engine oil filler cap/dipstick.
- ⑬ Air filter housing.
- ⑭ Carburettor drain screw.
- ⑮ Secondary engine ON/OFF switch.
- ⑯ Priming bulb.
- ⑰ Pressure release valve.

## 6. TECHNICAL DESCRIPTION

---

### 6.2 MAIN COMPONENT DESCRIPTIONS

- ① Used to fill the fuel tank, also covers the fuel filter/strainer.
- ② Remove this cover to access the spark plug.
- ③ Choke lever, used to aid cold starting.
- ④ Pull to start engine, several pulls may be required.
- ⑤ Used to isolate power from reaching the spark plug.
- ⑥ Exhaust gases are emitted here.
- ⑦ 12V DC outlet to power 12V devices, charge 12V batteries etc.
- ⑧ Indicator LEDs to indicate power and fault conditions.
- ⑨ Throttle switch, turns throttle control on and reduces engine RPM when no load is applied.
- ⑩ Earth point for connecting earth cable to earth/ground spike.
- ⑪ 230V outlets to power domestic equipment.
- ⑫ Engine oil filler cap with built in dipstick.
- ⑬ Air filter housing, remove to access air filter.
- ⑭ Carburettor drain screw, unscrew to drain fuel prior to storage.
- ⑮ Used to isolate power from reaching the spark plug.
- ⑯ Used to manually pump fuel to the carburetor for ease of starting.
- ⑰ Used to vent any vapour pressure or vacuum that may have built up in the fuel tank.

## 7. UNPACKING & CHECKING

---

### 7.1 PACKAGING

Carefully remove the machine from the packaging and examine it for any sign of damage that may have happened during shipping. Lay the contents out and check them against the parts shown below. If any part is damaged or missing; please contact the Draper Helpline (the telephone number appears on the Title page) and do not attempt to use the machine. The packaging material should be retained at least during the guarantee period: in case the machine needs to be returned for repair.

Warning! Some of the packaging materials used may be harmful to children. Do not leave any of these materials in the reach of children.

If any of the packaging is to be thrown away, make sure they are disposed of correctly; according to local regulations.

### 7.2 WHAT'S IN THE BOX?

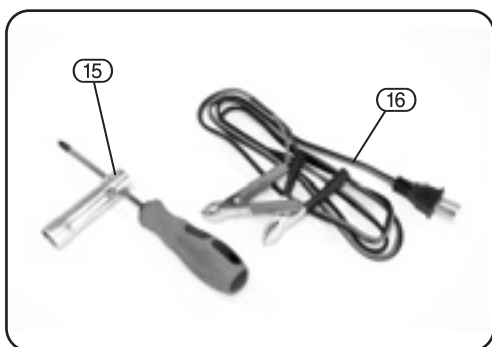

15 Tools.

16 12V DC battery charging lead.

## 8. PREPARING THE GENERATOR

---

**WARNING!** The generator is shipped without oil in the engine. You MUST add the required amount of oil before trying to start the engine.

### **8.1 ADDING ENGINE OIL**

1. Place the generator on a level surface.
2. Loosen the maintenance cover retaining screw and remove the maintenance cover.
3. With the generator on a level surface, remove the oil filler cap/dipstick.
4. Add enough SAE 10W-30 4 stroke oil (high than SJ Grade) to bring the oil level up to the required level indicated on the dipstick.

#### **DO NOT OVERFILL THE ENGINE WITH OIL**

If the engine is overfilled, the excess oil may be transferred to and contaminate the air filter and it's housing.

5. Screw in the filler cap/dipstick securely.
6. Re-install the maintenance cover.

### **8.2 ADDING FUEL - FIGS. 3 - 4**

This engine is certified to operate on unleaded petrol with a pump octane rating of 86 or higher.

Never use stale or contaminated petrol or an oil/petrol mixture. Avoid getting dirt or water in the fuel tank.

If the fuel level is low, refuel in a well-ventilated area with the engine stopped. If the engine has been running, allow it to cool first. Never refuel the engine inside a building where petrol fumes can reach flames or sparks.

You may use regular unleaded petrol containing no more than 10% Ethanol (E10) or 5% Methanol by volume. In addition, Methanol must contain solvents and corrosion inhibitors.

Use of fuels with content of Ethanol or Methanol greater than shown above may cause starting and/or performance problems. It may also damage metal, rubber and plastic parts of the fuel system.

Engine damage or performance problems that result from using a fuel with percentages of Ethanol or Methanol greater than shown above are not covered under warranty.

With the engine stopped, add fuel to the generator in a well-ventilated area.

**WARNING!:** Petrol is highly flammable and explosive.

You can be burned or seriously injured when handling fuel.

- Stop the engine and keep heat, sparks and flame away.
- Handle fuel only outdoors.
- Wipe up spills immediately.

## 8. PREPARING THE GENERATOR

The engine on/off switch must be switched to the "off" position.

1. Remove the fuel tank cap (Fig.3).
2. Fuel carefully to avoid spilling fuel.

Do not fill the fuel tank above the upper limit mark (Fig.4) on the fuel strainer.

**CAUTION!** Fuel can damage the paint and plastic. Be careful not to spill fuel when filling your fuel tank. Damage caused by spilled fuel is not covered under warranty.

3. After refuelling, tighten the fuel tank cap securely (Fig.5) for storage or transport. The engine on/off switch must be switched to the "off" position. Turn the switch to the "on" position once you are ready to run the machine.

Before attempting to start the generator you should twist the fuel cap vent clockwise to open it, this allows air to enter as the fuel drains hence avoiding the creation of a vacuum that could cause fuel starvation.

Move the generator at least 10 feet (3 metres) away from the fuelling source and site before starting the engine.

After initial fuelling (or anytime the generator is run completely out of fuel), starting the engine may require additional pulls of the starter cord. This generator utilises a vacuum operated fuel pump and may require additional pulls to draw fuel into the carburettor.

### 8.3 BEFORE OPERATION

Ensure that all operatives have received proper instruction in the safe use of this machine and fully understand it's controls as well as knowing how to stop this machine in an emergency.

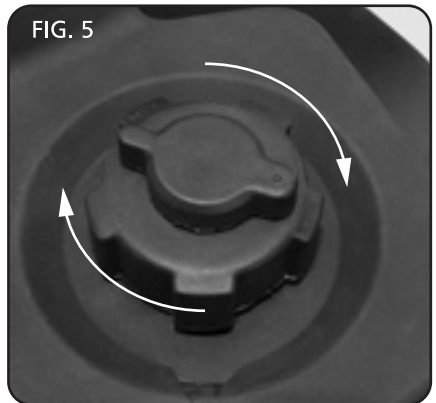
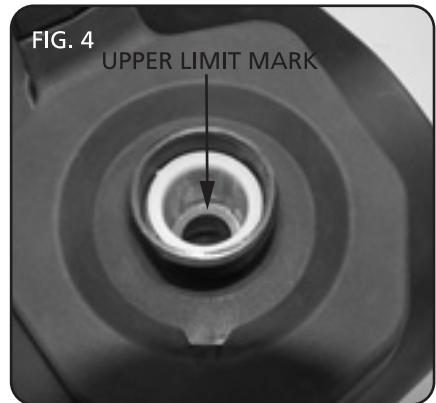

## 8. PREPARING THE GENERATOR

---

### 8.4 BEFORE EACH USE:- PRE-OPERATION CHECK

Once the machine has been prepared for use following the instructions above, ensure the following pre-operation checks are carried out.

1. Check the generator over for any signs of fuel.
2. Check the level of engine oil and top-up as required.  
**WARNING!** Running this machine with too little or too much oil can cause serious damage and would not be covered under warranty.
3. Check to ensure that there is no damage to the machine's casing and control panel.
4. Once you are satisfied that the machine is undamaged and in a good serviceable condition, you are ready to start the machine.

## 9. STARTING THE GENERATOR

---

### 9.1 STARTING THE GENERATOR

**WARNING!** For your safety do not operate the generator in an enclosed area such as a garage. The generator's exhaust emits gases containing poisonous carbon monoxide which can cause unconsciousness and even death in high concentrations.

Before connecting loads/appliances to the generator, be sure to read the chapters on **AC OPERATION** and **DC OPERATION** that follow this section.

Prior to each starting of the machine, perform the pre-operation check.

To start the machine follow these simple steps:-

1. Ensure that no appliances are plugged into the machine (starting the machine with appliances connected could cause damage to the appliances).
2. Move the choke lever to the "on" position to start the engine from cold to restart a warm engine leave the choke lever in the "off" position.
3. Turn the engine switch to the "on" position.
4. Press the primer bulb at least 6 times to ensure fuel has reached the carburettor.
5. Pull the starter cord gently until you feel resistance then give a brisk pull on the starter cord, several pulls on the starter cord may be required to start the engine.

**NOTE:** Do not allow the extended starter cord to snap back against the engine casing as damage to the starter or housing can occur.

6. If the choke lever was moved to the "on" position to start the engine from cold, gradually move it to the "off" position as the engine warms up.
7. If you wish to use the throttle control system, turn the throttle switch to the "on" position once the machine has warmed up for 2 or 3 minutes.
8. Refer to the following sections titled **AC OPERATION** and **DC OPERATION** for connecting loads to the generator.

## 9. STARTING/STOPPING THE GENERATOR

---

### 9.2 *STOPPING THE GENERATOR*

To stop the engine in an emergency, switch the engine on/off switch to off.

Under normal operating conditions, use the procedure detailed below to stop the generator:-

1. Unplug any appliances and/or charging batteries from the generator, if the generator has been working hard allow it to idle for a short time.
2. Switch off the engine, the fuel valve will automatically close.
3. Allow the engine to fully cool before transporting or returning to storage.



# 10. USING THE GENERATOR

## 10.1 CONTROL PANEL - FIG. 6

FIG. 7



### THROTTLE SWITCH

The throttle switch turns the throttle function on and off. When turned on the throttle system automatically reduces the engines speed when all loads are turned off or disconnected. When appliances are turned on or re-connected the engine returns to it's normal operating speed to power the appliances. This helps reduce fuel consumption, CO<sup>2</sup> emissions and is better for the environment. If high electrical loads are to be connected simultaneously, switch the throttle function off to reduce voltage fluctuation due to changes in engine speed. The throttle switch should be turned off when using items that have a high start-up current demand/load draw.

### EARTH TERMINAL

The earth terminal is connected to the frame of the generator, the non-current carrying metal parts of the generator and the earth terminals of each output socket. This earth terminal must be used to earth/ground this generator during use.

### OUTPUT INDICATOR

The output indicator light (green) is illuminated when the generator is operating normally and supplying power to it's output sockets.

### OVERLOAD INDICATOR

If the generator is overloaded (in excess of 2kVA) or if there is a short circuit in a connected appliance, the overload indicator light (red) will illuminate. The overload indicator light will stay on and after around 4 seconds current to the connected appliances will be turned off and the output indicator light (green) will go out.

# 10. USING THE GENERATOR

---

## **OIL ALERT SYSTEM**

The generator is fitted with an oil alert system that is designed to prevent engine damage caused by a low oil level in the engine. Before the oil level can fall to a level that can cause premature engine wear and damage the oil alert indicator light will come on and the oil alert system will automatically stop the engine (the engine switch will remain in the "on" position). If when starting the generator the oil alert light comes on or the engine suddenly stops running during use, check the engine oil level immediately.

## **DC CIRCUIT PROTECTOR**

The DC circuit protector will automatically shut off the DC power when the DC circuit is overloaded, when there is a problem with a battery that is being charged (short circuit) or when the connections between the battery and generator are improper (polarity). When the DC circuit protection is activated the DC circuit protector button will protrude from its housing, when this happens correct the fault or disconnect the defective battery and press the DC circuit protector button back into its housing to turn back on the DC power. You may need to wait a few minutes for the protection device to cool and allow the button to be reset for next use.

# 10. USING THE GENERATOR

---

## 10.2 AC APPLICATIONS

Before connecting an appliance or power cord to the generator:-

**NOTE:** Allow 2-3 minutes after starting the generator to allow the generator to settle before connecting AC appliances and using the throttle economy switch.

1. Make sure that it is in good working order. Faulty appliances or power cords can create the potential for electric shock.
2. If an appliance begins to operate abnormally in any way, turn it off immediately and disconnect it from the generator and check that the appliance does not exceed the generator's maximum rating.

Always make sure that the appliance's power rating does not exceed the generator's maximum rating. Power levels close to the generator's maximum rating can be used for a maximum of 30 minutes.

For continuous operation the maximum power requirement of the appliance is 1600VA. For intermittent operation (30 minutes MAX) the maximum power requirement of the appliance is 2000VA.

In either case the total power requirements (VA) of all appliances connected must be considered. The above limits must not be exceeded.

When powering sensitive electronics it is advisable to only power a single appliance at a time.

**NOTE:** Substantial overloading will switch off the engine. Exceeding the time limits advised above for maximum power operation or slightly overloading the generator may not switch off the generator but will shorten the service life of the generator.

# 10. USING THE GENERATOR

## 10.3 AC APPLICATIONS AND OPERATION - FIG. 7

1. Start the engine and make sure the output indicator light (green) is on (Fig.8).
2. Plug in the appliance. Most electronic appliances require more than their rated wattage for startup.

If the generator is overloaded (in excess of 2,000VA), or if there is a short circuit in a connected appliance, the overload indicator light (red) will go ON. The overload indicator light (red) will stay ON, and after about four seconds, current to the connected appliance(s) will shut off, and the output indicator light (green) will go OFF. Stop the engine and investigate the problem.

Determine if the cause is a short circuit in a connected appliance or an overload. Correct the problem and restart the generator.

Before connecting an appliance to the generator, make sure that it is in good order and that its electrical rating does not exceed that of the generator. Then start the generator and connect the appliance power lead.

**NOTE:** When an electric motor is started, the overload indicator light (red) may come on. This is normal, if the overload indicator light (red) goes off after about four seconds. If the overload indicator light (red) stays on, consult the Draper helpline (contact number on rear of manual).

**NOTE:** This machine is fitted with dual engine stop switches. One is located on the generator's front control panel and another rotary switch is located below the pull start handle. In an emergency either stop switch can be used.



FIG. 7

# 10. USING THE GENERATOR

## 10.4 DC OPERATION - FIG. 8

The DC socket should ONLY be used for charging 12-volt automotive type batteries. The DC charging output is not regulated. This generator does not charge 6V batteries.

When using the DC output, turn the throttle switch to the "OFF" position.

NOTE: The 12V DC output should be used to charge wet cell lead acid batteries only.

### CONNECTING THE BATTERY CHARGING CABLE

1. Always remove the battery you want to charge from the vehicle or appliance prior to charging.

**WARNING!** The battery gives off explosive gases; keep sparks, flames and cigarettes away.

Provide adequate ventilation when charging or using batteries.

**WARNING!** Battery posts, terminals and related accessories contain lead and lead components.

Wash hands after handling.

2. Plug the battery charging cable into the 12V DC socket of the generator.
3. Connect the red lead of the battery charging cable to the positive (+) battery terminal and the black lead to the negative (-) battery terminal.
4. Start the generator.



## 10. USING THE GENERATOR

---

**CAUTION!** An overloaded DC circuit, excessive current draw by the battery, or a wiring problem will trip the DC circuit protector (Red button extends out). If this happens, wait a few minutes before pushing in the circuit protector to resume operation. If the DC circuit protector continues to activate, discontinue charging and see your authorised generator dealer.

### **10.5 DISCONNECTING THE BATTERY CHARGING CABLE - FIG. 9**

1. Stop the engine.
2. Disconnect the black lead of the battery charging cable from the negative (-) battery terminal.
3. Disconnect the red lead of the battery charging cable from the positive (+) battery terminal.
4. Disconnect the battery charging cable from the DC socket of the generator.
5. Re-install the charged battery into the vehicle or appliance following the vehicle or appliance manufacturers instructions.



# 11. MAINTENANCE

---

## 11.1 THE IMPORTANCE OF MAINTENANCE

Good maintenance is essential for the safe, economical and trouble-free operation of the generator. It will also help reduce air pollution.

**Warning! Improper maintenance, or failure to correct a problem before operation, can cause a malfunction in which could cause serious injury or death.**

**Always follow the inspection and maintenance recommendations and schedules in this owner's manual.**

To help you to properly care for your generator, the following pages include a maintenance schedule, routine inspection procedures and simple maintenance procedures using basic hand tools. Other service tasks that are more difficult, or require special tools, are best handled by professionals and are normally performed by a technician or other qualified mechanic.

The maintenance schedule applies to normal operating conditions. If you operate your generator under severe conditions, such as sustained high-load or high temperature operation, or use it in usually wet or dusty conditions, consult your servicing dealer for recommendations applicable to your individual needs and use.

Remember that your servicing dealer knows your generator best and is fully equipped to maintain and repair it. To ensure the best quality and reliability, use only new, genuine Draper parts for repair or replacement.

## 11.2 MAINTENANCE SAFETY

Some of the most important safety precautions follow. However, we cannot warn you of every conceivable hazard that can arise in performing maintenance. Only you can decide whether or not you should perform a given task.

**Warning! Failure to properly follow maintenance instructions and precautions can cause you to be seriously hurt or killed.**

**Always follow the procedures and precautions in the owner's manual.**

### Safety Precautions

- Make sure the engine is off and cool before you begin any maintenance or repairs. This will eliminate several potential hazards:
  - **Carbon monoxide poisoning from engine exhaust.**  
Be sure there is adequate ventilation whenever you operate the engine.
  - **Burns from hot parts.**  
Let the engine and exhaust system cool before touching.
  - **Injury from moving parts.**  
Do not run the engine unless instructed to do so.
- Read the instructions before you begin and make sure you have the tools and skills required.
- To reduce the possibility of fire or explosion, be careful when working around petrol. Use only a non-flammable solvent, not petrol, to clean parts. Keep cigarettes, sparks and flames away from all fuel-related parts.

# 11. MAINTENANCE

## 11.3 MAINTENANCE SCHEDULE

REGULAR SERVICE PERIOD		Before each use	First month or 20hrs	Every 3 months or 50hrs	Every 6 months or 100hrs	Every 2 years or 300hrs
ITEM	Perform at every indicated month or operating hour interval, whichever comes first.					
Engine oil	Check level	○				
	Change		○		○	
Air cleaner	Check	○				
	Clean			○(1)		
Spark plug	Check Adjust				○	
	Replace					○
Valve clearance	Check Adjust					○(2)
Combustion chamber	Clean	After every 300 hrs (2)				
Fuel tank and filter	Clean	Every year (2)				
Fuel line	Check	Every 2 years (replace if necessary) (2)				

(1) Service more frequently when used in dusty areas.

(2) These items should be serviced by your servicing dealer, unless the owner has the proper tools and is mechanically proficient.

(3) For commercial use, log hours of operation to determine proper maintenance intervals. Failure to follow this maintenance schedule could result in non-warrantable failures.

### 11.4 ENGINE OIL CHANGE - FIG. 10

Drain the used oil while the engine is warm. Warm oil drains quickly and completely.

1. Turn the engine switch to the "OFF" position to reduce the possibility of fuel leakage.
2. Loosen the cover screw and remove the left side maintenance cover.
3. Place a suitable container next to the engine to catch the used oil.
4. Remove the oil filler cap/dipstick and drain the oil into the container by tipping the engine toward the oil filler neck.
5. With the engine in a level position, fill to the upper limit of the oil filler neck with the recommended oil.
6. Re-install the oil filler cap/dipstick securely.
7. Re-install the left side maintenance cover and tighten the cover screw securely.



**Wash your hands with soap and water after handling used oil.**

**Warning!** Improper disposal of engine oil can be harmful to the environment. If you change your own oil, please dispose of it properly. Put it in a sealed container and take it to a recycling centre. Do not discard it in a rubbish bin, dump it on the ground or pour it down a drain.



# 11. MAINTENANCE

## 11.5 AIR CLEANER SERVICE - FIGS. 11 - 12

A dirty air cleaner will restrict air flow to the carburettor. To prevent carburettor malfunction, service the air cleaner regularly. Service more frequently when operating the generator in extremely dusty areas.

**Warning!** Using petrol or flammable solvent to clean the air filter can cause a fire or explosion. Use only soapy water or non-flammable solvent.

**CAUTION!** Operating the engine without an air filter or with a damaged air filter will allow dirt to enter the engine, causing rapid engine wear. This type of damage is not covered by the Draper warranty.

1. Loosen the cover screw and remove the left side maintenance cover (Fig.12).
2. Press the latch tab on the top of the air cleaner case and remove the air cleaner cover.
3. Wash the air filter in a solution of household detergent and warm water, then rinse thoroughly or wash in non-flammable or high flash point solvent. Allow the air filter to dry thoroughly.
4. Soak the air filter in clean engine oil and squeeze out the excess oil. The engine will smoke during initial startup if too much oil is left in the air filter.
5. Clean the air filter case with a moist cloth (Fig.13).
6. Re-install the air filter.
7. Re-install the air filter cover securely.
8. Re-install the side maintenance cover and tighten the retaining screw securely.

FIG. 11



FIG. 12



# 11. MAINTENANCE

## 11.6 SPARK PLUG SERVICE - FIGS.13 - 15

In order to service the spark plug, you will need the spark plug wrench supplied in the tool bag.

Recommended spark plugs: A7RTC (LD) Draper Stock No.23133.

To ensure proper engine operation, the spark plug must be properly gapped and free of deposits.

**CAUTION!** An incorrect spark plug can cause engine damage.

If the engine has been running, allow it to cool before servicing the spark plug.

1. Remove the spark plug maintenance cover (Fig.14).
2. Remove the spark plug cap (Fig.15).
3. Clean any dirt from around the spark plug base.
4. Use a spark plug wrench to remove the spark plug.
5. Visually inspect the spark plug. Replace it if the electrodes are worn or if the insulator is cracked, chipped or fouled.
6. Measure the spark plug electrode gap with a feeler gauge. Correct the gap, if necessary, by carefully bending the side electrode.

The gap should be:  
0.024 0.028 in (0.60 0.70mm) (Fig.16).

7. Check that the spark plug sealing washer is in good condition and thread the spark plug in by hand to prevent cross-threading.
8. After the spark plug is seated, tighten with a spark plug wrench to compress the washer.

If installing a new spark plug, tighten  $\frac{1}{2}$  turn after the spark plug seats to compress the washer. If re-installing a used spark plug, tighten  $\frac{1}{8}$ th to  $\frac{1}{4}$  turn after the spark plug seats to compress the washer.

**CAUTION!** A loose spark plug can overheat and damage the engine. Over tightening the spark plug can damage the threads in the cylinder head.

9. Re-install the spark plug cap on the spark plug securely.
10. Re-install the spark plug maintenance cover.

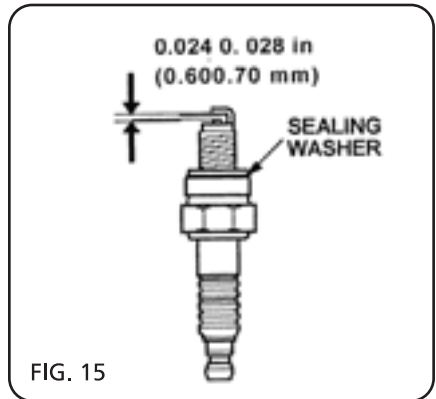

# 12. TROUBLESHOOTING

---

## 12.1 ENGINE WILL NOT START

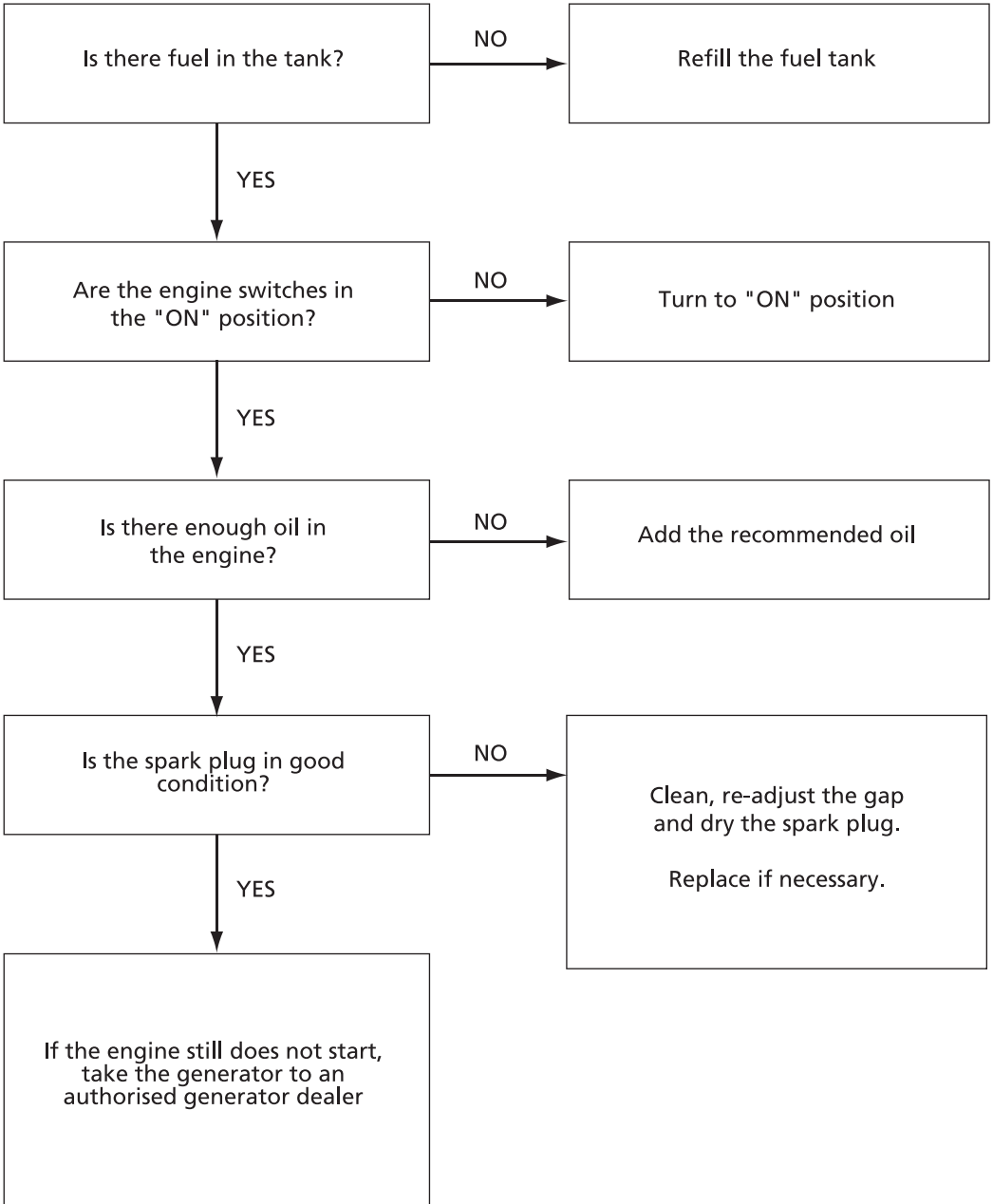

# 12. TROUBLESHOOTING

## 12.2 ENGINE STARTS BUT GENERATOR DOES NOT OPERATE

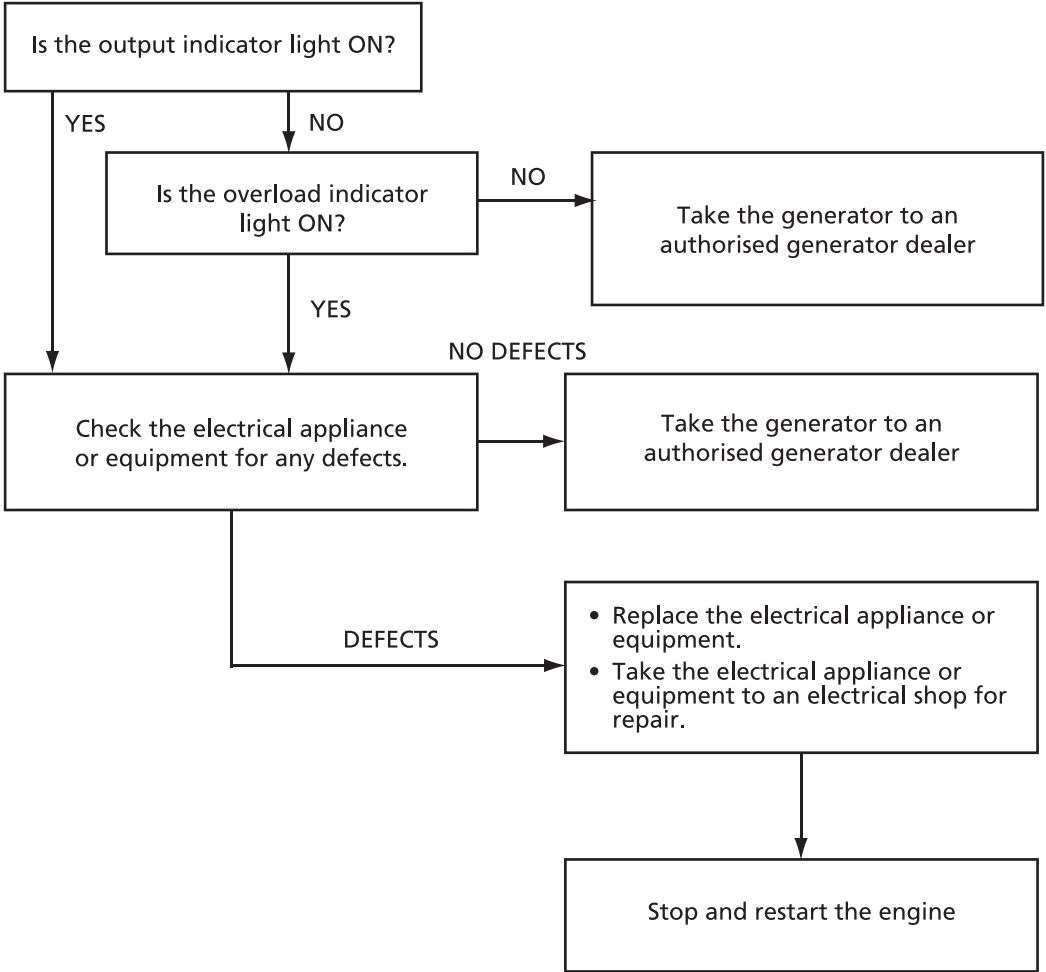

### NO ELECTRICITY AT THE DC SOCKET:

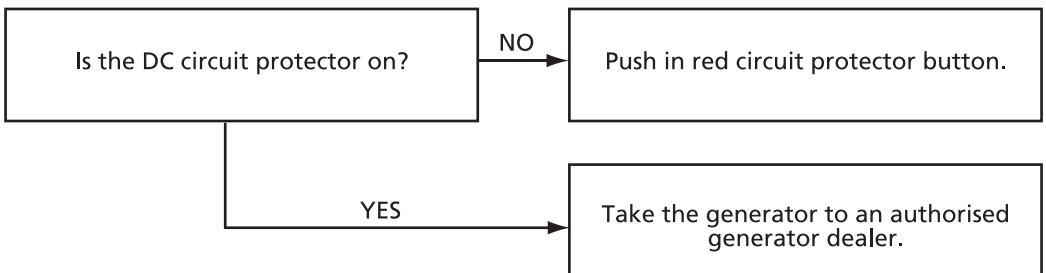

# 13. EXPLANATION OF SYMBOLS

## 13.1 EXPLANATION OF SYMBOLS



Attention.



Outdoor use only.



Warning!  
Hot parts.



Danger of electric shock.



Danger of fire.



Not weatherproof.



Warning! Noise.  
Wear ear defenders.



Warning!  
Read the instruction manual.



Caution!  
Read the instruction manual.



Hot parts.  
Keep distance.



Warning!  
Shock hazard  
earth point.



Caution!  
Stop engineer.



Caution!  
Low oil.



Not for indoor use.



Shock Hazard!  
Read manual  
before use.





- **DRAPER TOOLS LIMITED,**  
Hursley Road, Chandler's Ford,  
Eastleigh, Hampshire. SO53 1YF. U.K.
- **Helpline:** (023) 8049 4344
- **Sales Desk:** (023) 8049 4333
- **Website:** [www.drapertools.com](http://www.drapertools.com)
- **E-mail:** [sales@drapertools.com](mailto:sales@drapertools.com)
- **Sales Fax:** (023) 8049 4209
- **General Enquiries:** (023) 8026 6355
- **Service/Warranty Repair Agent**  
For aftersales servicing or warranty repairs, please contact the Draper Tools Helpline for details of an agent in your local area.

YOUR DRAPER STOCKIST