

DRAPER
Expert

GB

230V 16 SPEED BENCH/FLOOR STANDING DRILL

95314 / 95092



Stock No.95314 shown

CE

These instructions accompanying the product are the original instructions. This document is part of the product, keep it for the life of the product passing it on to any subsequent holder of the product. Read all these instructions before assembling, operating or maintaining this product.

This manual has been compiled by Draper Tools describing the purpose for which the product has been designed, and contains all the necessary information to ensure its correct and safe use. By following all the general safety instructions contained in this manual, it will ensure both product and operator safety, together with longer life of the product itself.

All photographs and drawings in this manual are supplied by Draper Tools to help illustrate the operation of the product.

Whilst every effort has been made to ensure the accuracy of information contained in this manual, the Draper Tools policy of continuous improvement determines the right to make modifications without prior warning.

1. TITLE PAGE

1.1 INTRODUCTION:

USER MANUAL FOR: 230V 16 Speed Bench/Floor Standing Drill

Stock No's: 95314 & 95092

Part No's: BD650/16E & DP650/16E

1.2 REVISIONS:

Date first published November 2018.

As our user manuals are continually updated, users should make sure that they use the very latest version.

Downloads are available from: <http://drapertools.com/manuals>

Draper Tools Limited
Hursley Road
Chandler's Ford
Eastleigh
Hampshire
SO53 1YF
UK

Website: drapertools.com

Product Helpline: +44 (0) 23 8049 4344

General Fax: +44 (0) 23 8026 0784

1.3 UNDERSTANDING THIS MANUALS SAFETY CONTENT:

WARNING! – Information that draws attention to the risk of injury or death.

CAUTION! – Information that draws attention to the risk of damage to the product or surroundings.

1.4 COPYRIGHT © NOTICE:

Copyright © Draper Tools Limited.

Permission is granted to reproduce this publication for personal and educational use only. Commercial copying, redistribution, hiring or lending is prohibited.

No part of this publication may be stored in a retrieval system or transmitted in any other form or means without written permission from Draper Tools Limited.

In all cases this copyright notice must remain intact.

2. CONTENTS

1. TITLE PAGE	
1.1 INTRODUCTION.....	2
1.2 REVISION HISTORY	2
1.3 UNDERSTANDING THIS MANUAL	2
1.4 COPYRIGHT NOTICE	2
2. CONTENTS	
2.1 CONTENTS.....	3
3. WARRANTY	
3.1 WARRANTY.....	4
4. INTRODUCTION	
4.1 SCOPE.....	5
4.2 SPECIFICATION	5
4.3 HANDLING AND STORAGE.....	5
5. HEALTH AND SAFETY INFORMATION	
5.1 GENERAL SAFETY INSTRUCTIONS FOR POWER TOOL USE	6-7
5.2 ADDITIONAL SAFETY INSTRUCTIONS FOR DRILLS	8
5.3 CONNECTION TO THE POWER SUPPLY	9
6. TECHNICAL DESCRIPTION	
6.1 IDENTIFICATION	10
7. UNPACKING AND CHECKING	
7.1 PACKAGING	11
7.2 WHAT'S IN THE BOX?.....	11
8. PREPARING THE DRILL	
8.1 BASE TO COLUMN	12
8.2 TABLE BRACKET	12
8.3 TABLE	13
8.4 HEADSTOCK.....	13
8.5 PLUNGE HANDLES.....	13
8.6 CHUCK AND ARBOR.....	14
8.7 CHUCK GUARD.....	14
8.8 BENCH/FLOOR MOUNTING.....	14
9. SETTING THE DRILL	
9.1 SPINDLE SPEED ADJUSTMENT.....	15
9.2 BRILL BIT INSTALLATION/REPLACEMENT	16
9.3 NO-VOLT SWITCH.....	16
9.4 WORK TABLE ADJUSTMENT	17
9.5 GENERAL DRILLING.....	18
9.6 DUST AND SWarf	18
10. TROUBLESHOOTING	
10.1 TROUBLESHOOTING	19
11. MAINTENANCE	
11.1 MAINTENANCE	20
11.2 ARBOR REMOVAL	20
12. OPTIONAL ACCESSORIES	
12.1 OPTIONAL ACCESSORIES.....	21
13. EXPLANATION OF SYMBOLS	
13.1 EXPLANATION OF SYMBOLS	22
14. DISPOSAL	
14.1 DISPOSAL.....	23
DECLARATION OF CONFORMITY	ENCLOSED

3. WARRANTY

3.1 WARRANTY

Draper tools have been carefully tested and inspected before shipment and are guaranteed to be free from defective materials and workmanship.

Should the tool develop a fault, please return the complete tool to your nearest distributor or contact:

Draper Tools Limited, Chandler's Ford, Eastleigh, Hampshire, SO53 1YF. England.

Telephone Sales Desk: (023) 8049 4333 or:

Product Helpline (023) 8049 4344.

A proof of purchase must be provided.

If upon inspection it is found that the fault occurring is due to defective materials or workmanship, repairs will be carried out free of charge. This warranty period covering labour is 12 months from the date of purchase except where tools are hired out when the warranty period is 90 days from the date of purchase. The warranty is extended to 24 months for parts only. This warranty does not apply to any consumable parts, any type of battery or normal wear and tear, nor does it cover any damage caused by misuse, careless or unsafe handling, alterations, accidents, or repairs attempted or made by any personnel other than the authorised Draper warranty repair agent.

Note: If the tool is found not to be within the terms of warranty, repairs and carriage charges will be quoted and made accordingly.

This warranty applies in lieu of any other warranty expressed or implied and variations of its terms are not authorised.

Your Draper warranty is not effective unless you can produce upon request a dated receipt or invoice to verify your proof of purchase within the warranty period.

Please note that this warranty is an additional benefit and does not affect your statutory rights.

Draper Tools Limited.

4. INTRODUCTION

4.1 SCOPE

This product is intended for trade use and has the quality and features to meet and exceed the expectations of the most demanding user. Any application other than that it was intended for, is considered misuse.

Designed to drill into wood, plastics, ceramics, and many metals (drill bits sold separately).

4.2 SPECIFICATION

Stock No.	95314	95092
Part No.	BD650/16E	DP650/16E
Rated voltage	230V	230V
Rated frequency	50Hz	50Hz
Rated input	650W	650W
Speed settings	16	16
Revolutions per minute (no load)	120-3,000min ⁻¹	120-3,000min ⁻¹
Chuck capacity	3-16mm	3-16mm
Drilling capacity	19mm	19mm
Spindle taper	MT2	MT2
Spindle travel	80mm	80mm
Throat	178mm	178mm
Column Ø	80mm	80mm
Collar Ø	60mm	60mm
Chuck to table	323mm	648mm
Chuck to base	515mm	1171mm
Table tilt	±45°	±45°
Head rotation	360°	360°
Table rotation	360°	360°
Table dimensions	290x290mm	290x290mm
Base dimensions	460x275mm	460x275mm
Height	1000mm	1650mm
Sound power level.....	85db(A)	85db(A)
Sound pressure level	70db(A)	70db(A)
Vibration level	<2.5m/s ²	<2.5m/s ²
Weight	71kgs	78kgs

4.3 HANDLING & STORAGE

- Care must be taken when handling this product.
 - Dropping this power tool could have an effect on its accuracy and could also result in personal injury. This product is not a toy and must be respected.
- Environmental conditions can have a detrimental effect on this product if neglected.
 - Exposure to damp air can gradually corrode components.
 - If the product is unprotected from dust and debris, components will become clogged.
 - If not cleaned and maintained correctly or regularly, the machine will not perform at its best.

* *Continuous A-Weighted Sound Pressure Level at the workstation in accordance to prEN ISO 15744:1999 and declared according to EN ISO 4871.*

** *A-Weighted Sound Power Level in accordance to prEN ISO 15744:1999 and declared according to EN ISO 4871.*

5. HEALTH AND SAFETY INFORMATION

When using any type of power tool there are steps that should be taken to make sure that you, as the user, remain safe.

Common sense and a respect for the tool will help reduce the risk of injury.

5.1 GENERAL SAFETY INSTRUCTIONS FOR POWER TOOL USE

Warning!

- Read all safety warnings and all instructions. Failure to follow the warnings and instructions may result in electric shock, fire and/or serious injury.
- The term "power tool" in the warnings refers to your mains operated (corded) power tool or battery-operated (cordless) power tool.

Most important: You must know how to safely start and stop this machine, especially in an emergency.

Keep the work area tidy and clean. Attempting to clear clutter from around the machine during use will reduce your concentration. Mess on the floor creates a trip hazard. Any liquid spilled on the floor could result in you slipping.

Find a suitable location. If the machine is bench mounted, the location should provide good natural light or artificial lighting as a replacement. Avoid damp and dusty locations as it will have a negative effect on the machine's performance. If the machine is portable do not expose the tool to rain. In all cases do not operate power tools near any flammable materials.

Keep bystanders away. Children, onlookers and passers by must be restricted from entering the work area for their own protection. The barrier must extend a suitable distance from the tool user.

Unplug and house all power tools that are not in use. A power tool should never be left unattended while connected to the power supply. They must be housed in a suitable location, away locked up and from children.

Do not overload or misuse the tool. All tools are designed for a purpose and are limited to what they are capable of doing. Do not attempt to use a power tool (or adapt it in any way) for an application it is not designed for. Select a tool appropriate for the size of the job. Overloading a tool will result in tool failure and user injury. This covers the use of accessories.

Dress properly. Loose clothing, long hair and jewellery are all dangerous because they can become entangled in moving machinery. This can also result in parts of body being pulled into the machine. Clothing should be close fitted, with any long hair tied back and jewellery and neck ties removed. Footwear must be fully enclosed and have a non-slip sole.

Wear personal protective equipment (PPE). Dust, noise, vibration and swarf can all be dangerous if not suitably protected against. If the work involving the power tool creates dust or fumes wear a dust mask. Vibration to the hand, caused by operating some tools for longer periods must be protected against. Wear vibration reducing gloves and allow long breaks between uses. Protect against dust and swarf by wearing approved safety goggles or a face shield. These are some of the more common hazards and preventions, however, always find out what hazards are associated with the machine/work process and wear the most suitable protective equipment available.

Do not breathe contaminated air. If the work creates dust or fumes connect the machine (if possible) to an extraction system either locally or remotely. Working outdoors can also help if possible.

Move the machine as instructed. If the machine is hand held, do not carry it by the power supply cable. If the product is heavy, employ a second or third person to help move it safely or use a mechanical device. Always refer to the instructions for the correct method.

Do not overreach. Extending your body too far can result in a loss of balance and you falling. This could be from a height or onto a machine and will result in injury.

Maintain your tools correctly. A well maintained tool will do the job safely. Replace any damaged or missing parts immediately with original parts from the manufacturer. As applicable keep blades sharp, moving parts clean, oiled or greased, handles clean and emergency devices working.

5. HEALTH AND SAFETY INFORMATION

Wait for the machine to stop. Unless the machine is fitted with a safety brake, some parts may continue to move due to momentum. Wait for **all** parts to stop, then unplug it from the power supply before making any adjustments, carrying out maintenance operations or just finishing using the tool.

Remove and check setting tools. Some machinery requires the use of additional tools or keys to set, load or adjust the power tool. Before starting the power tool always check to make certain they have been removed and are safely away from the machine.

Prevent unintentional starting. Before plugging any machine in to the power supply, make sure the switch is in the OFF position. If the machine is portable, do not hold the machine near the switch and take care when putting the machine down, that nothing can operate the switch.

Carefully select an extension lead. Some machines are not suitable for use with extension leads. If the tool is designed for use outdoors, use an extension lead also suitable for that environment. When using an extended lead, select one capable of handling the current (amps) drawn by the machine in use. Fully extend the lead regardless of the distance between the power supply and the tool. Excess current (amps) and a coiled extension lead **will** both cause the cable to heat up and can result in fire.

Concentrate and stay alert. Distractions are likely to cause an accident. Never operate a power tool if you are under the influence of drugs (prescription or otherwise), including alcohol or if you are feeling tired. Being disorientated **will** result in an accident.

Have this tool repaired by a qualified person. This tool is designed to conform to the relevant international and local standards and as such should be maintained and repaired by someone qualified, using only original parts supplied by the manufacturer. This **will** ensure the tool remains safe to use.

5. HEALTH AND SAFETY INFORMATION

5.2 ADDITIONAL SAFETY INSTRUCTIONS FOR DRILLS

MECHANICAL HAZARDS:

1. **Crushing.** When setting/changing a tool or maintaining the machine avoid crushing injuries sustained between fixed and moving elements of the machine.
2. **Cutting or Severing.** At all times the workpiece shall be clamped as manual support will lead to injury.
3. **Entanglement.** Switch off the machine for maintenance, workpiece loading/unloading, swarf/chip removal, cutting/lubrication fluid application as contact with rotating spindle or tool will cause entanglement and possibly lead to injury and entrapment.
4. **Impact.** Ensure the workpiece is securely clamped at all times to avoid sudden movement (rotation) or ejection causing injury. Ensure any special tools associated with tool exchange, i.e. chuck key are removed prior to attempting to start the machine.
5. **Stabbing, Cutting or Puncture Wounds.** Take care when handling the tools and avoid contact with swarf and burrs created during drilling as they are extremely sharp.

ELECTRICAL HAZARDS:

1. **Contact with Live parts.** During commissioning, maintenance and trouble shooting operations do not remove, open or expose any electrical, terminal and control boxes due to the danger of electrocution. If the main cable is damaged, unplug the machine immediately and have the cable replaced before continuing.

AUDIBLE HAZARDS:

1. **Hearing Loss.** Wear ear defenders during operation to avoid damage to hearing, however ensure this does not interfere with speech communications or audible warnings.

MATERIAL HAZARDS:

1. **Contact and Inhalation.** Wear personal protective equipment to avoid contact from harmful fluids, gases or dust thrown or created during the drilling process.
2. **Fire or Explosion.** Do not drill or drill in the vicinity of flammable or combustible materials.

LOCATION:

1. **Posture.** Ensure when mounting the machine that the chosen location does not lead to unhealthy posture or repetitive strain during normal operation.
2. **Lighting.** Adequate lighting must be provided to ensure no operations are light impaired possibly leading to injury.
3. **Reach.** Do not reach over or around the machine at any time.

UNEXPECTED START-UP:

1. **Remove the plug.** Remove the plug from the socket before carrying out adjustment, servicing or maintenance.

ERRORS OF FITTING:

1. **Tools.** Ensure a suitable tool for the job in hand is securely and correctly fitted prior to starting the machine. Guards shall be fitted and in place at all times.

STABILITY:

1. **Toppling.** The drill shall be securely bolted down to a suitable and level surface to prevent the machine from overturning leading to injury.
2. **Slipping.** Ensure the area is clean of any residue cutting/lubrication fluid and other materials which may lead to a slip, trip or other such hazard.

5. HEALTH AND SAFETY INFORMATION

5.3 CONNECTION TO THE POWER SUPPLY

Caution: Risk of electric shock. Do not open.

This appliance is supplied with a moulded 3 pin mains plug for your safety. The value of the fuse fitted is marked on the pin face of the plug. Should the fuse need replacing, ensure the substitute is of the correct rating, approved to BS1362 and ASTA or BSI Kite marked.

ASTA 

BSI 

The fuse cover is removable with a small plain slot screwdriver. Ensure the fuse cover is replaced before attempting to connect the plug to an electrical outlet. If the cover is missing, a replacement must be obtained or the plug replaced with a suitable type.

If a replacement plug is to be fitted this must be carried out by a qualified electrician.

The damaged or incomplete plug, when cut from the cable should be disabled to prevent connection to a live electrical outlet.

This appliance is Class I† and is designed for connection to a power supply matching that detailed on the rating label and compatible with the plug fitted.

If an extension lead is required, use an approved and compatible lead rated for this appliance. If using an extension lead, follow the instructions that came with your lead regarding maximum load while cable is wound, if in doubt ensure the entire cable is unwound. Using a coiled extension lead will generate heat which could melt the lead and cause a fire.

†*Earthed* : This product requires an earth connection to protect against electric shock from accessible conductive parts in the event of failure of the basic insulation.

IMPORTANT

If using an extension lead, follow the instructions that came with your lead regarding maximum load while cable is wound. If in doubt, ensure that the entire cable is unwound. Using a coiled extension lead will generate heat which could melt the lead and cause a fire.

6. TECHNICAL DESCRIPTION

6.1 IDENTIFICATION

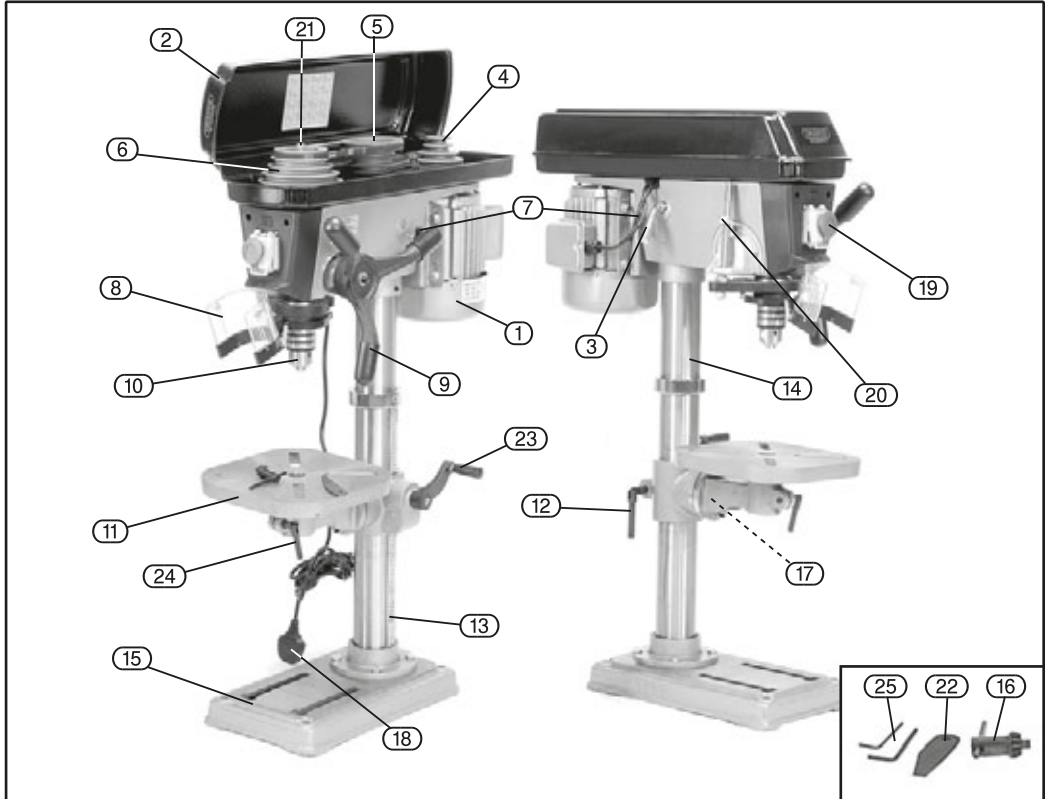

- | | |
|--|---------------------------------|
| ① Motor. | ⑬ Rack. |
| ② Pulley cover. | ⑭ Column. |
| ③ Motor tension lever. | ⑮ Base. |
| ④ Motor pulley. | ⑯ Chuck key. |
| ⑤ Intermediate pulley. | ⑰ Work table tilt locking bolt. |
| ⑥ Spindle pulley. | ⑱ BS moulded plug & cable. |
| ⑦ Motor tension locking knob. | ⑲ No-volt on/off switch. |
| ⑧ Guard. | ⑳ Depth stop. |
| ⑨ Plunge handle assembly. | ㉑ Spindle. |
| ⑩ Geared chuck. | ㉒ Drift key. |
| ⑪ Work table. | ㉓ Table height crank handle. |
| ⑫ Work table height/rotation locking handle. | ㉔ Table locking handle. |
| | ㉕ Hex. keys. |

7. UNPACKING AND CHECKING

7.1 PACKAGING

Carefully remove the product from the packaging and examine it for any sign of damage that may have happened during shipping. If any part is damaged or missing, please contact the Draper Help Line (the telephone number appears on the Title page) and do not attempt to use the product.

The packaging material should be retained at least during the guarantee period in case the machine needs to be returned for repair.

Warning!

- Some of the packaging materials used may be harmful to children. Do not leave any of these materials in the reach of children.
- If any of the packaging is to be thrown away, make sure they are disposed of correctly, according to local regulations.

7.2 WHAT'S IN THE BOX?

The packaging contains several parts and semi-assembled elements that require final assembly. Lay out the contents and check off the items against those featured below.

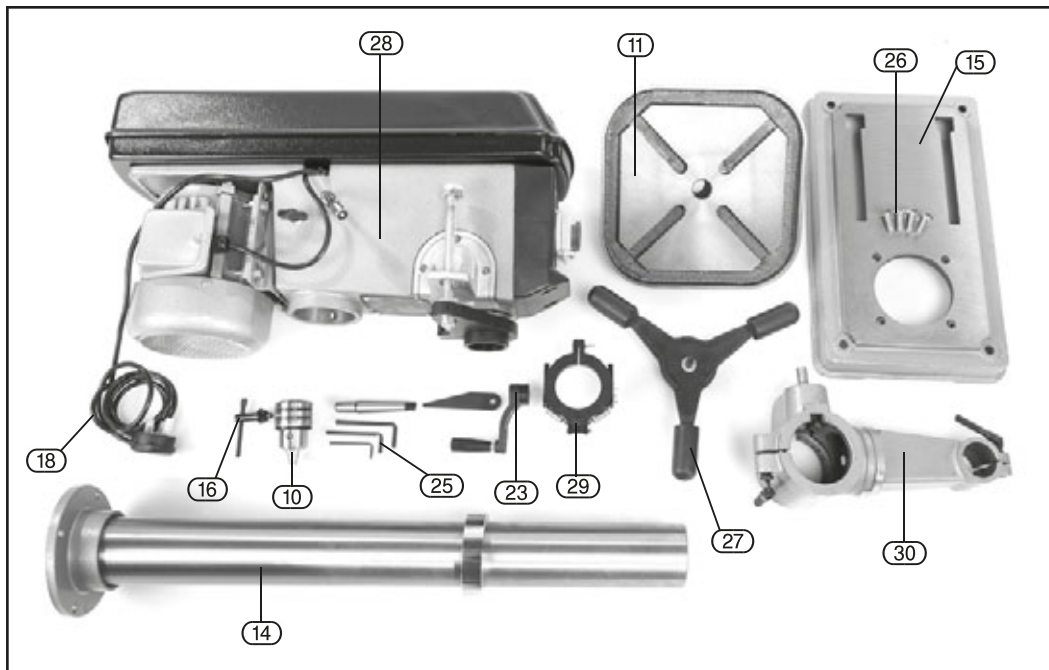

(10) Geared chuck.

(11) Work table.

(14) Column.

(15) Base.

(16) Chuck key.

(18) Moulded plug & cable.

(23) Table height
crank handle.

(25) Hexagon keys.

(26) Bolts and washers.

(27) Plunger handles.

(28) Body.

(29) Guard assembly.

(30) Work table bracket.

8. PREPARING THE DRILL

WARNING: The headstock, and consequently when fully assembled the drilling machine, are extremely heavy. Care shall be taken when manoeuvring. The use of a hoist should be employed to ensure safety.

NOTE: Remove the plug from the socket before carrying out adjustment, servicing or maintenance.

8.1 BASE TO COLUMN - FIG. 1

Align the column (B) onto the base (A) and secure with the four 16mm bolts (C).

NOTE: Do not overtighten the bolts as this may crack the casting.

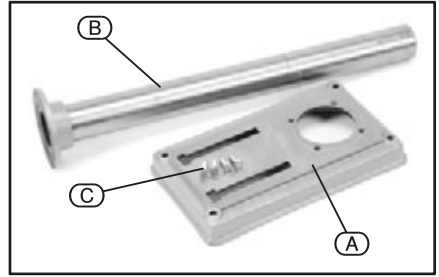

FIG.1

8.2 TABLE BRACKET - FIGS. 2 - 5

Loosely screw locking handle (D) into rear of the table bracket. Pass the pinion gear (E) inside the table bracket and pass the shaft out through the housing side. The pinion gear shaft has one flat side on which the crank handle (F) secures. Tighten the locking grub screw with a 3mm hex. key.

NOTE: The toothed rack (G) must be orientated so the larger non toothed section is upper most.

Position the rack (G) against the column and pass the table bracket over.

Align the teeth on the rack with those of the worm gear inside the table arm.

When the gear and rack teeth are intermeshed, the rack and table arm can be lowered over/down the column.

NOTE: The rack must be held in position while lowering to avoid movement.

Locate the bottom end of the rack into the top edge of the column base. The bevelled edge holds the rack against the column.

Tighten the table height locking handle.

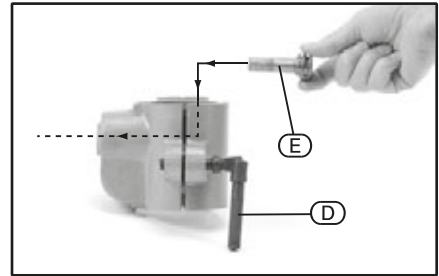

FIG.2

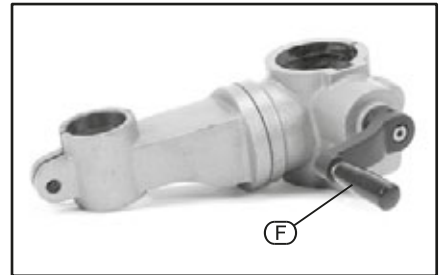

FIG.3



FIG.4

8. PREPARING THE DRILL

Slide the column ring (H) over the column and locate the bevel on the top edge of the rack into the bevelled rim of the ring. Tighten grub screw (I) to secure.

NOTE: Adjust the table arm height to suit and position centrally over the base before securing the locking handle.

8.3 TABLE - FIG. 6

Slot the table into the table bracket and tighten locking handle (J).

8.4 HEADSTOCK - FIG. 7

WARNING: The headstock assembly poses a significant health and safety hazard while being lifted and positioned into place. Seek assistance.

Lift the headstock (K) onto the top of the column. When aligned and located down onto the column fully, tighten grub screws (L) with the hex. key supplied.

NOTE: Adjust the drill head over the table and base before securing. The use of a plumb bob may be beneficial to improve accuracy.

8.5 PLUNGE HANDLES - FIG. 8

Locate the plunge handle assembly (M) onto the hub ensuring locating pin (N) is in position.

Secure with the hex. socket head bolt and washer (O).



FIG.5

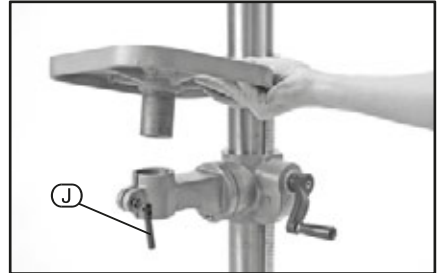

FIG.6

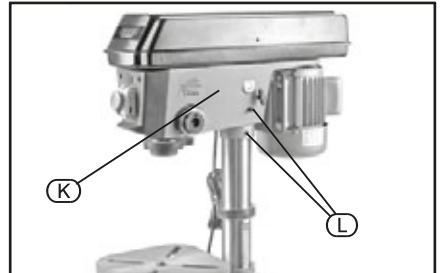

FIG.7

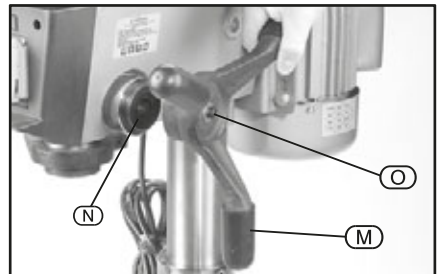

FIG.8

8. PREPARING THE DRILL

8.6 CHUCK AND ARBOR - FIGS. 9 - 10

The drill chuck, arbor and headstock spindle join together with an interference fit formed by the matched tapers of the mating surfaces.

Ensure all mating surfaces are clean as any debris will cause the taper to miss-align possibly resulting in the chuck or arbor coming loose creating a potential hazard.

Using the chuck key provided open the chuck until the jaws are completely recessed and protected from damage.

Insert the short taper end of the arbor (P) into the back of chuck (Q). A sharp tap with a soft blow mallet will securely join them together.

NOTE: Ensure the chuck is on a surface that will not absorb the force of the mallet. If the chuck does not mate securely, repeat the process.

Insert the long taper end of arbor (P) into the spindle. Rotate the chuck assembly until the arbor locates allowing complete insertion.

Tap the chuck to securely locate it in place.

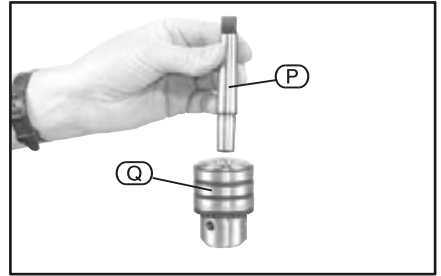

FIG.9



FIG.10

8.7 CHUCK GUARD - FIG. 11

Loosen the cross slot machine screw and nut (R). Pass the chuck guard (S) over the chuck onto collar (T). When located fully and aligned on the collar, tighten the machine screw and nuts to secure the chuck guard in place.

NOTE: Do not over tighten as it may damage the guard.

To adjust the lower acrylic guard section down and fully cover the chuck and drill bits, loosen wing nuts (U).

When adjustment is complete, tighten the locking nuts.

NOTE: The chuck guard shall be inspected before each use to determine effectiveness and correct functionality.

The chuck guard shall be adjusted and positioned between the chuck and operator for all processes. Replace a damaged or missing chuck guard before continuing to use the drilling machine.

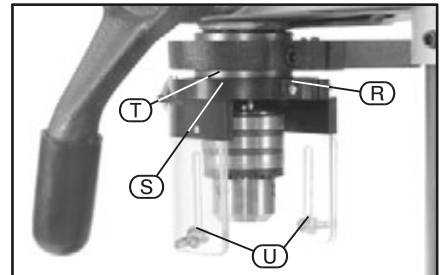

FIG.11

8.8 BENCH/FLOOR MOUNTING

Securely bolt the drilling machine to a work bench or other secure surface as appropriate through the various points in the base (fixings are not supplied). Suitable fixings should be sourced applicable to the load and mounting surface. Ensure there is enough clear space around the drilling machine to accommodate larger items which may be drilled.

Ensure the load created by the drilling machine, operator and workpiece combined will not compromise the integrity of the intended mounting surface/floor space.

9. SETTING THE DRILL

NOTE: Remove the plug from the socket before carrying out adjustment, servicing or maintenance.

9.1 SPINDLE SPEED ADJUSTMENT FIGS. 12 - 14

This drilling machine is equipped with 16 drilling speeds. Remove the pulley cover securing screw. Select the speed most suitable for the intended application†.

Loosen both the locking knobs (V) and adjust the motor tension lever (W) releasing the tautness across the drive belts.

Move the belt to the corresponding sections of the motor, intermediate and spindle pulleys ensuring the belts remain horizontal.

Apply pressure to the motor tension lever (W) to tension the drive belt. With the correct tension achieved. Tighten both locking knobs (V).

Gently lower the pulley cover before tightening pulley cover securing screw.

Never attempt to operate the drilling machine with the pulley cover open or not fully secured.

CAUTION: Over tensioning the drive belt will accelerate belt wear, increase the loading on drive bearings and the motor possibly leading to premature failure. Under tensioning the drive belt will lead to the drive belt slipping and increased noise.

†As a general rule material with a softer composition can be drilled faster as they cut more easily. Harder materials require a slower speed as attempting to make the hole at a high speed will result in the drill bit over heating which may result in a poorly finished hole, the bit annealing or the bit breaking.

Drilling wood too slowly can cause splintering.

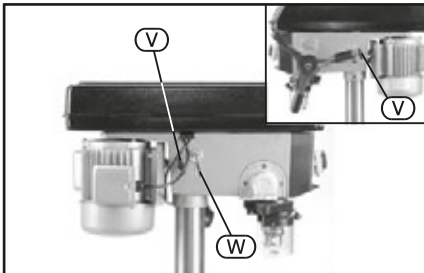

FIG. 14

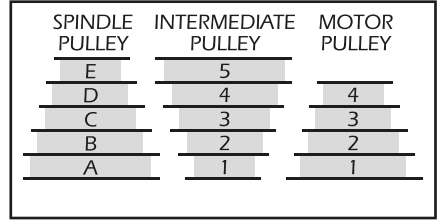

FIG. 12

Setting	Speed	Drive Belt Position	
		Spindle	Motor
1	210 min ⁻¹	A - 1	4 - 4
2	280 min ⁻¹	A - 1	3 - 3
3	320 min ⁻¹	B - 2	4 - 4
4	420 min ⁻¹	B - 2	3 - 3
5	500 min ⁻¹	C - 3	4 - 4
6	540 min ⁻¹	A - 1	2 - 2
7	800 min ⁻¹	E - 5	4 - 4
8	830 min ⁻¹	D - 4	3 - 3
9	1,110 min ⁻¹	E - 5	3 - 3
10	1,290 min ⁻¹	C - 3	2 - 2
11	1,350 min ⁻¹	B - 2	1 - 1
12	1,580 min ⁻¹	D - 4	2 - 2
13	2,050 min ⁻¹	E - 5	2 - 2
14	2,180 min ⁻¹	C - 3	1 - 1
15	2,580 min ⁻¹	D - 4	1 - 1
16	3,340 min ⁻¹	E - 5	1 - 1

BD650/16E

Setting	Speed	Drive Belt Position	
		Spindle	Motor
1	210 min ⁻¹	A - 1	4 - 4
2	280 min ⁻¹	A - 1	3 - 3
3	320 min ⁻¹	B - 2	4 - 4
4	420 min ⁻¹	B - 2	3 - 3
5	500 min ⁻¹	C - 3	4 - 4
6	540 min ⁻¹	A - 1	2 - 2
7	800 min ⁻¹	E - 5	4 - 4
8	830 min ⁻¹	D - 4	3 - 3
9	1,110 min ⁻¹	E - 5	3 - 3
10	1,290 min ⁻¹	C - 3	2 - 2
11	1,350 min ⁻¹	B - 2	1 - 1
12	1,580 min ⁻¹	D - 4	2 - 2
13	2,050 min ⁻¹	E - 5	2 - 2
14	2,180 min ⁻¹	C - 3	1 - 1
15	2,580 min ⁻¹	D - 4	1 - 1
16	3,340 min ⁻¹	E - 5	1 - 1

DP650/16E

FIG. 13

9. SETTING THE DRILL

9.2 DRILL BIT INSTALLATION/ REPLACEMENT - FIG. 15

The drilling machine is equipped with a geared chuck and a separate key to secure the bit in the chuck jaws.

Selection of the correct accessory is dependent on material type and the intended application.

Ensure the selected accessory is suitable and speed compatible with the drilling machine.

Place the bit into the chuck. Insert the chuck key (X) into apertures (Y) engaging the teeth.

Rotate the key clockwise to grip. All three apertures should be tightened to make certain of a firm grip.

Always use a good quality sharp drill bit/cutter.

WARNING: The drill bit will be hot after use.

9.3 NO-VOLT SWITCH - FIG. 16

In the event of a power supply disruption the machine will require manually restarting once power has been returned.

To switch the machine on, press the green button marked 'P'.

To switch the machine off, press the red button marked 'O'. However, the yellow cover with integral red stop button must be left covering the switches so, in the event of an accident or emergency striking the stop button will activate the off switch.

Prior to starting the drilling machine make a visual check, to ensure the guards are in place and correctly functioning, the bit is correctly installed with the chuck key removed and no other parts are damaged proving a potential hazard.

Ensure all locking handles are tight prior to starting the drilling machine.

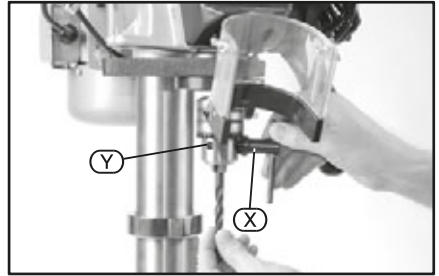

FIG.15

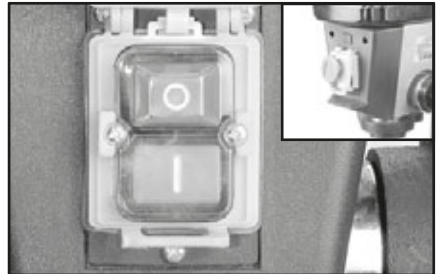

FIG.16

9. SETTING THE DRILL

9.4 WORK TABLE ADJUSTMENT - FIGS. 17 - 18

For versatility, the work table (Z) can be raised or lowered, tilted $\pm 45^\circ$ or rotated 360° around the column. To tilt the table, tighten nut (AA) clockwise until the locating pin can be removed from the casting. Store in a safe location. Loosen the 24mm bolt (AB).

Adjust the table's degree of tilt and re-secure with locking bolt (AB). Use the scale as a guide. Alternatively use a protractor off the table to the drill bit for more accuracy.

When the table is back in a level position insert the location pin for the factory setting. Move the nut along the thread until the end of the thread is protected by the nut, allowing use of a small hammer to tap the pin in place.

To raise/lower the table working height, loosen locking handle (AC) and turn the height adjustment crank handle (AD) to raise or lower the table. Alternatively while locking handle (AC) is loose the table can be rotated 180° to further increase the distance between the chuck and workpiece. When the adjustments are complete re-secure locking handle (AC).

The slots in the work table and base can accommodate locking bolts to secure a small vice enabling safe clamping of the workpiece.

CAUTION: A drill bit snagging on a piece of work will violently grab the piece of material, whipping it round and is likely to result in personal injury. Always ensure the workpiece is securely clamped.

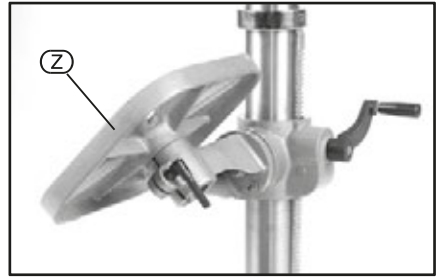

FIG.17

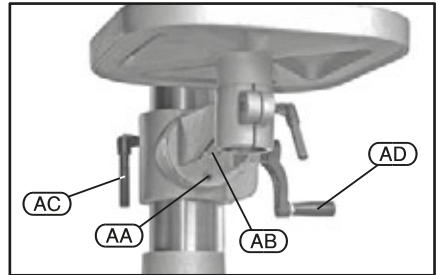

FIG.18

9. SETTING THE DRILL

9.5 GENERAL DRILLING - FIG. 19

For repeated drilling to a consistent depth, set the depth stop facility (AE).

As a guide the depth is indicated on the scale.

NOTE: For accuracy, set up the depth using a steel rule.

Lower the chuck and drill bit to the required position by rotating the plunge handles (AF) anti-clockwise.

Set the position with nut (AG) against the stop (AH) and lock with nut (AI).

Use a scrap piece of material to test before beginning on the workpiece.

When drilling metal it is good practice to use a cutting fluid to aid lubrication, swarf removal and as a coolant.

This will result in increased cutting performance and help prolong the life of the bit. A few drops of oil will suffice in the absence of a specific cutting fluid.

9.6 DUST AND SWARF

All wood dust (including dust from composites like chipboards and fibre boards etc) is hazardous to health: it can affect the nose, the respiratory system and the skin. For example MDF (medium density fibreboard) which contains formaldehyde is a known carcinogen.

A correctly fitted dust mask, suitable for the activity and in accordance to the relevant standard, must be worn.

For work activities involving exposure to fine wood dust a mask rated to at least FFP2 should be used.

Swarf produced by metal cutting is extremely sharp. Take care when breaking the chips/clearing the bit.

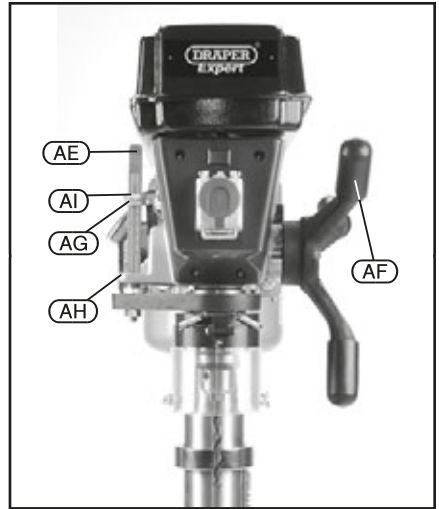

FIG.19

10. TROUBLESHOOTING

10.1 TROUBLESHOOTING

WARNING: For your safety always turn the main switch on the machine “off” and remove the plug from the power supply before carrying out any maintenance or troubleshooting.

Problem	Cause	Remedy
Machine will not start.	1.Fuse. 2.Other.	1.Replace/reset time delay fuse or circuit breaker. 2.Return to an authorised service agent for diagnosis.
Noisy operation.	1.Incorrect belt tension. 2.Dry spindle. 3.Loose spindle pulley or motor pulley.	1.Adjust tension. 2.Lubricate spindle with grease. 3.Tighten set screws in pulleys.
Bit burns or smokes.	1.Incorrect speed. 2.Swarf not coming out of hole. 3.Blunt bit. 4.Feeding too slow. 5.Not lubricated.	1.Change speed. 2.Retract bit frequency to clear swarf. 3.Sharpen or replace bit. 4.Feed fast enough to allow drill to cut. 5.Lubricate bit.
Excessive drill run-out or wobble.	1.Bent bit. 2.Worn spindle bearings. 3.Bit not properly installed in chuck. 4.Chuck not properly installed.	1.Use a straight bit. 2.Return to an authorised service agent. 3.Install bit centrally. 4.Refit chuck properly.
Drill binds in workpiece.	1.Workpiece pinching bit or excessive feed pressure. 2.Improper belt tension.	1.Support or re-clamp workpiece. 2.Adjust tension.

11. MAINTENANCE

11.1 MAINTENANCE

Regular inspection and cleaning reduces the necessity for maintenance operations and will keep your tool in good working condition.

The motor must be correctly ventilated during tool operation. For this reason avoid blocking the air inlets. After use disconnect the tool from the power supply and vacuum the ventilation slots.

If the replacement of the supply cord is necessary, this has to be done by the manufacturer or his agent in order to avoid a safety hazard.

At regular interval, lubricate the spindle with a medium purpose grease. With the pulley cover open, pack the grease down the centre of the front pulley. Operate the plunger mechanism and brush a thin film of grease on the quill. Clean any debris built up in the pulley housing. Spray a general purpose lubricating agent/rust inhibitor on the other moving parts and machined surfaces.

11.2 ARBOR REMOVAL - FIGS. 20 - 21

To aid removal of the arbor from the spindle a drift key is supplied.

Lower the spindle with the plunger handles to expose slot (AJ). Rotate the spindle to align the inner and outer slots.

Insert the drift key and allow the spindle to raise. Tap the drift key while supporting the chuck.

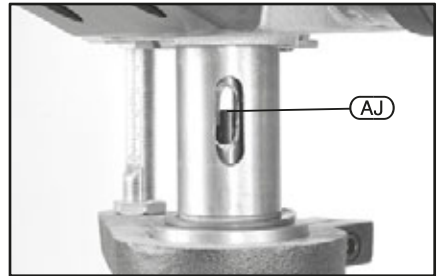

FIG.20



FIG.21

12. OPTIONAL ACCESSORIES

12.1 OPTIONAL ACCESSORIES

A range of drill bits and accessories are available from your local Draper Stockist.

Please visit our website for details: www.drapertools.com

13. EXPLANATION OF SYMBOLS

13.1 EXPLANATION OF SYMBOLS



Warning!
Read the instruction manual.



Warning!
Wear suitable eye/face/ear protection.



Warning!
Do not wear gloves.



Warning!
Remove plug from power supply before maintenance.



**Do not dispose of WEEE*
unsorted municipal waste.**

14. DISPOSAL

14.1 DISPOSAL

- At the end of the machine's working life, or when it can no longer be repaired, ensure that it is disposed of according to national regulations.
- Contact your local authority for details of collection schemes in your area.

In all circumstances:

- Do not dispose of power tools with domestic waste.
- Do not incinerate.
- Do not abandon in the environment.
- Do not dispose of WEEE* as unsorted municipal waste.



* Waste Electrical & Electronic Equipment.

CONTACTS

Draper Tools Limited, Hursley Road,
Chandler's Ford, Eastleigh, Hampshire. SO53 1YF. U.K.

Helpline: (023) 8049 4344

Sales Desk: (023) 8049 4333

Internet: drapertools.com

E-mail: sales@drapertools.com

General Enquiries: (023) 8026 6355

Service/Warranty Repair Agent:

For aftersales servicing or warranty repairs, please contact the
Draper Tools Helpline for details of an agent in your local area.

YOUR DRAPER STOCKIST

JLCM1118

©Published by Draper Tools Limited.

No part of this publication may be reproduced, stored in a retrieval system or transmitted in any form or by any means, electronic, mechanical photocopying, recording or otherwise without prior permission in writing from Draper Tools Ltd.