

# Mira Platinum Wireless Controller



These instructions must be left with the user

User Guide

*Showering perfection*

**mira**  
SHOWERS

# CONTENTS

<b>Introduction .....</b>	<b>3</b>
General.....	3
<b>Safety Information.....</b>	<b>3</b>
<b>Control Layout.....</b>	<b>4</b>
<b>Display Symbols.....</b>	<b>5</b>
<b>Using the Shower .....</b>	<b>6</b>
Switch On/Off .....	6
Adjust Temperature .....	7
Adjust Flow.....	7
<b>Functions .....</b>	<b>8</b>
<b>Function Menu.....</b>	<b>10</b>
<b>Changing Functions/Settings .....</b>	<b>11</b>
Maximum Showering Water Temperature .....	11
Eco .....	12
Warm-Up .....	13
Clock Setting .....	14
Clock Display.....	15
Flow Range .....	16
Control Frequency.....	18
Shower Countdown Enable.....	19
Shower Countdown Duration .....	20
<b>Replacing the Batteries .....</b>	<b>21</b>
<b>Fault Diagnosis.....</b>	<b>22</b>
Error Codes .....	22
General Faults.....	24
<b>Cleaning .....</b>	<b>26</b>
<b>Disposal and Recycling.....</b>	<b>26</b>
<b>notes.....</b>	<b>27</b>

# INTRODUCTION

## General

Thank you for purchasing a quality Mira product. To enjoy the full potential of your new product, please take the time to read this guide thoroughly and keep it handy for future reference.

The Mira Platinum Wireless Controller is a remote user interface and controls the following functions:

- Showering Water Temperature
- Showering Water Flow
- Maximum Showering Water Temperature
- Eco Mode
- Warm-Up Mode
- Clock
- Flow Range
- Shower Countdown

This guide covers the setting and use of these functions and includes a trouble shooting guide should the appliance not function as expected. For issues relating to the installation of the appliance or other associated products, please refer to the relevant Installation Guide(s) or contact our Customer Services Team. (Details in the back of this guide.)

**NOTE! ALL FUNCTIONS ARE ONLY AVAILABLE AFTER THE CONTROLLER HAS BEEN ASSIGNED TO A MIRA PLATINUM DIGITAL MIXER VALVE.** (See Mira Platinum Installation Guide.)

## SAFETY INFORMATION

1. Make sure that you fully understand how to operate this shower and make sure that it is properly maintained in accordance with the instructions given in this manual.
2. Sunburn or skin conditions can increase your sensitivity to hot water. Make sure that you set the shower to a cooler temperature.

# CONTROL LAYOUT

Turn Outer Ring  
Showering Water Flow Adjustment

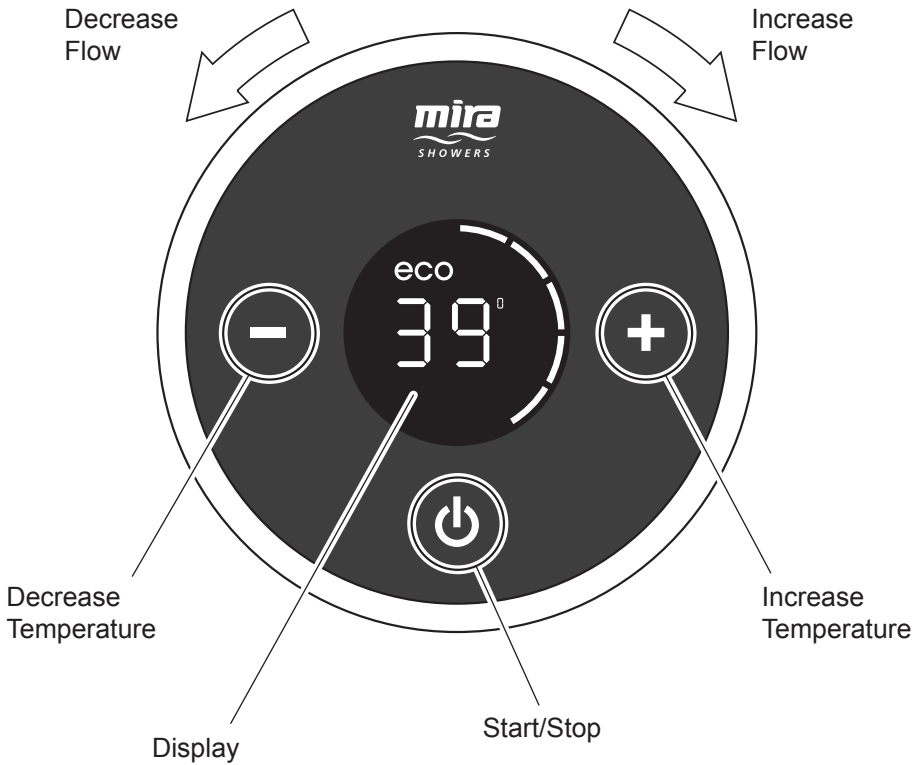

# DISPLAY SYMBOLS

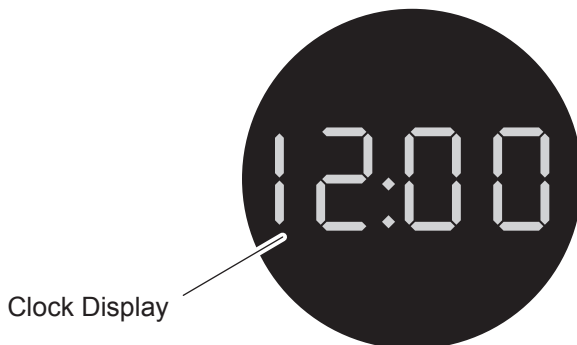
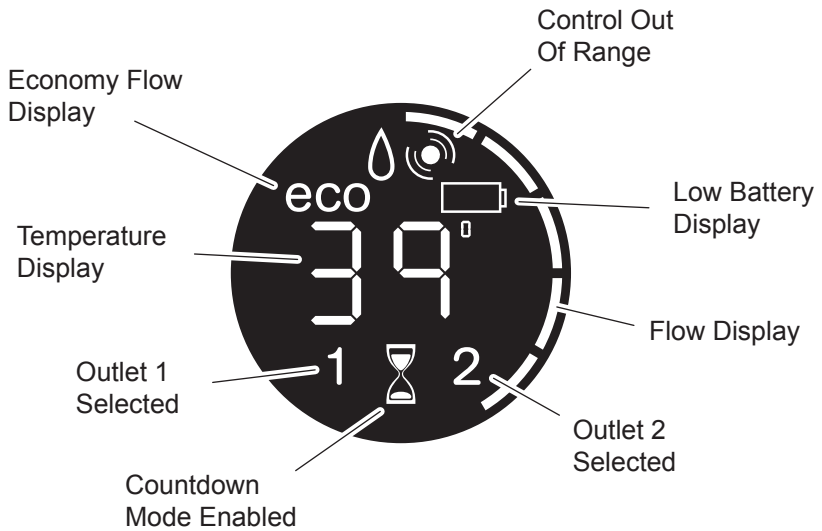

# USING THE SHOWER

## Switch On/Off

► Press “**⏻**” to start or stop shower.

Temperature and flow settings will be same as when last used.

After a short period, display will dim to help extend battery life.

Approximately 10 minutes after shower has stopped, display will turn off automatically.

Shower will not run continuously for more than 30 minutes before stopping automatically (unless “**ECO**” or “**Shower Countdown**” are enabled).

When “**Warm-Up**” function is “**on**”, there will be a short delay (5 seconds) before water flows from shower.



## Adjust Temperature

- ▶ While shower is running, press “+” or “-” to adjust temperature. Showering temperature appears on display in degrees Celsius (°C).

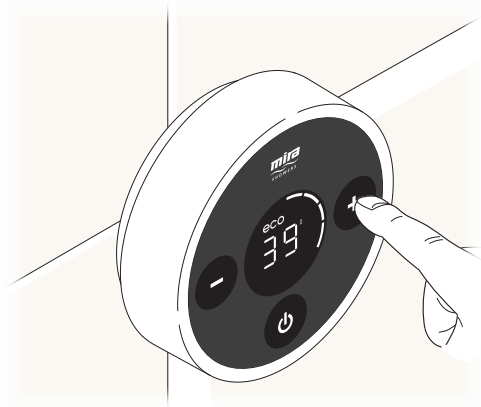

## Adjust Flow

- ▶ Turn outer ring clockwise or anticlockwise to adjust flow. Showering flow level appears on display in white bars.



# FUNCTIONS

The following functions can be altered individually to adjust how the shower operates:

**F1 - Maximum Showering Water Temperature.** This is the temperature the shower cannot go beyond when in use.

**F2 - Eco.** The shower will stop automatically after 5 minutes. When this setting is “on”, maximum available showering flow is limited to half the flow normally produced. “ECO” symbol is displayed. When setting is “off”, maximum showering flow will be at full flow. “ECO” symbol goes out when more than half flow is selected. When Eco is on Shower Countdown time will be overridden



**F3 - Warm-Up.** When this setting is “on” and the shower is started, there is a short delay (5 seconds) before water flows and temperature display will flash to indicate shower is waiting for selected display temperature to be achieved. When shower stops, temperature has been reached and shower is ready for use, press “ ” as normal. If temperature cannot be found, shower will stop automatically after 5 minutes.



When “Warm-Up” setting is “off”, temperature display will not flash and shower operates as normal.

**Note!** When used with some combination boilers, the warm-up function may be impaired. This is due to the functional nature of combination boilers.

**F4 - Clock Setting.** To set the time.

**F5 - Clock Display.** When Clock Display is “on”, time is displayed when shower has stopped, or after 10 seconds of inactivity whilst the shower is running. When Clock Display is “off”, the time is replaced by the showering temperature.



on



off

**F6 - Flow Range.** For use with High Pressure/Combi Valve version only. The water flow rate (showering force) can be adjusted to within a desired range by setting a low point and a high point. During adjustment the shower will need to be started.

**F7 - Control Frequency.** An unreliable functioning of the appliance (not always able to change settings of shower) may indicate radio interference by another device transmitting locally on same channel. Changing channel may resolve this problem.



**F8 - Shower Countdown Enable.** If enabled, the remaining shower time is shown instead of the clock. During the countdown the outer display segments will fade while passing through the full 360° but re-illuminate as each minute elapses, the Wireless User Interface will emit a single beep when 2 minutes are left on the countdown and 2 beeps as the final minute passes. For the final 10 seconds of showering the display is fully illuminated.

**F9 - Shower Countdown Duration.** If previous function (**F8 - Count Down Enable**) has been activated the operating duration of the shower can be adjusted in 1 minute increments of between 1 - 30 minutes.

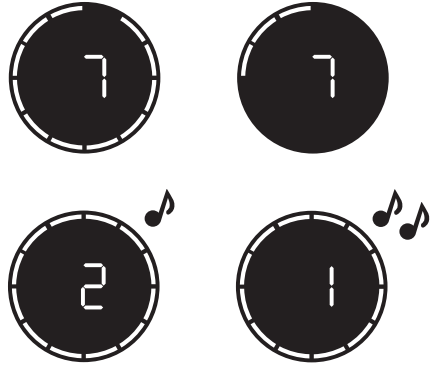

# FUNCTION MENU

## Enter the Function Menu

- ▶ Press “+” and “⏻” buttons simultaneously until “End” is displayed on the unit.



- ▶ Use “+” or “-” buttons to cycle through functions and press “⏻” to enter setting.

(See following sections in this guide for details on each function and how to alter their settings.) **Note!** If signal loss occurs during a function change, “Err” will appear on display.

Press “⏻” to clear and retry function change.

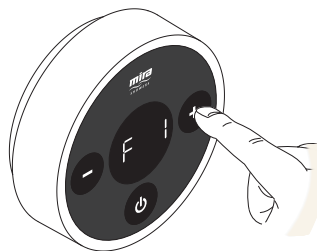

## Exit the Function Menu

- ▶ When finished, use “+” or “-” buttons to cycle back through functions until “End” appears. Press “⏻” to exit.

- ▶ Control is ready to use.

- ▶ If necessary, test shower to see if functions are working as expected.



# CHANGING FUNCTIONS/SETTINGS

## Maximum Showering Water Temperature

Factory default “45°C”.

- ▶ Cycle menu to “F 1” and press “⏻”.

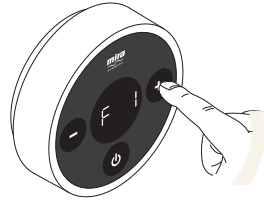

- ▶ Press “+” or “-” to adjust temperature.  
**Maximum = 48°C**  
**Minimum = 35°C**



- ▶ Press “⏻” to set.





- ▶ Press “⏻” to exit back to Function Menu. See section “Exit the Function Menu”.



## Eco

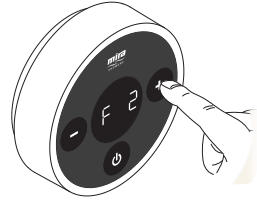

Factory default “off”.

- ▶ Cycle menu to “F 2” and press “A top-down view of a circular control panel with a black face and a silver rim. The panel features a digital display showing 'F 2', a minus sign (-) on the left, a plus sign (+) on the right, and a power button icon (a circle with a vertical line) at the bottom. A hand is shown pressing the power button.

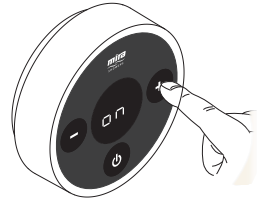
- ▶ Press “+” or “-” to change setting “on” or “off”.



- ▶ Press “A top-down view of the control panel. The display now shows 'Set'. A hand is shown pressing the power button icon.

- ▶ Press “A top-down view of the control panel. The display shows 'F 2', and the minus sign (-) and plus sign (+) buttons are visible on either side of the display.

## Warm-Up

Factory default “off”.

**Note!** Function will not work with combination boilers.

- ▶ Cycle menu to “F 3” and press “”.

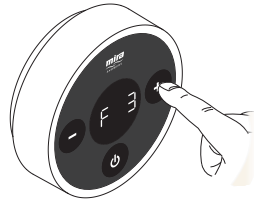

- ▶ Press “+” or “-” to change setting “on” or “off”.

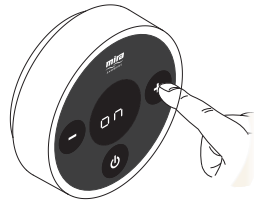

- ▶ Press “” to set.



- ▶ Press “” to exit back to Function Menu. See section “Exit the Function Menu”.



## Clock Setting

Factory default “10:00”.

**Note!** Can also be activated by disconnecting and reconnecting battery.

- ▶ Cycle menu to “F 4” and press “⏻”.

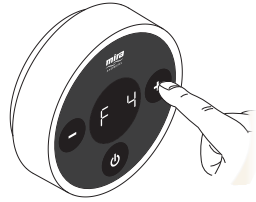

- ▶ Press “-” to change hour setting.



- ▶ Press “+” to change minute setting.



- ▶ Press “⏻” to set time and exit back to Function Menu. See section “Exit the Function Menu”.



## Clock Display

Factory default “on”.

- ▶ Cycle menu to “F 5” and press “⏻”.

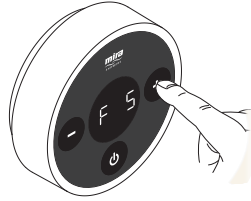

- ▶ Press “+” or “-” to change setting “on” or “off”.

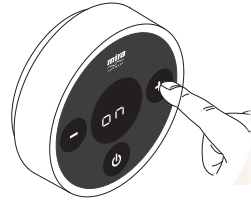

- ▶ Press “⏻” to set.

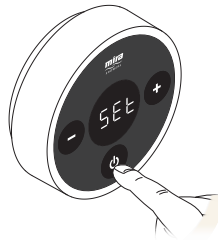

- ▶ Press “⏻” to exit back to Function Menu. See section “Exit the Function Menu”.



## Flow Range

For use with High Pressure/Combi Valve version only.  
Factory default "1 - 99"

- ▶ Cycle menu to "F 6" and press "⏻".



- ▶ "on" is displayed, press "⏻" to start shower.

- ▶ Lower limit is displayed, e.g. "L 1". Adjust flow to desired lower limit 1-99.



- ▶ Press "⏻" to set lower limit.

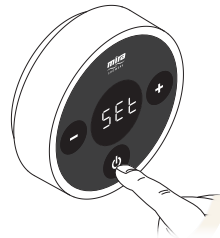



- ▶ Higher limit is displayed, e.g. “H 23”. Adjust flow to desired higher limit 1-99. (Most plumbing systems may achieve maximum flow before 99.)



- ▶ Press “⏻” to set higher limit.





- ▶ Press “⏻” to set and exit back to Function Menu. See section “Exit the Function Menu”.



## Control Frequency

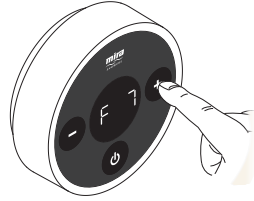

Factory default “1”.

- ▶ Cycle menu to “F 7” and press “A circular control panel with a black face and a white outer ring. The face has four buttons: a minus sign (-), a power button (⏻), a plus sign (+), and a power button (⏻). The display shows 'F 7'. A hand is shown pressing the power button (⏻) on the right side of the panel.

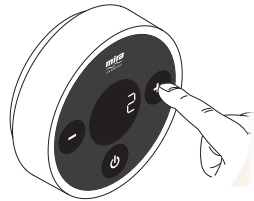
- ▶ Press “+” or “-” to change channel “1-3”.





- ▶ Press “A circular control panel with a black face and a white outer ring. The face has four buttons: a minus sign (-), a power button (⏻), a plus sign (+), and a power button (⏻). The display shows 'SET'. A hand is shown pressing the power button (⏻) on the right side of the panel.

- ▶ Press “A circular control panel with a black face and a white outer ring. The face has four buttons: a minus sign (-), a power button (⏻), a plus sign (+), and a power button (⏻). The display shows 'F 7' and a plus sign (+) to the right of the display.

## Shower Countdown Enable

Factory default “off”.

- ▶ Cycle menu to “F 8” and press “A line drawing of a circular shower control panel. The display shows 'F 8'. A hand is shown pressing the '+' button on the right side of the panel. There are also '-' and power buttons on the left side.

- ▶ Press “+” or “-” to change setting “on” or “off”.



- ▶ Press “A line drawing of a circular shower control panel. The display shows 'Set'. A hand is shown pressing the power button at the bottom left of the panel. There are also '-' and '+' buttons on the left and right sides respectively.

- ▶ Press “A line drawing of a circular shower control panel. The display shows 'F 8'. There are '-' and '+' buttons on the left and right sides respectively, and a power button at the bottom left.

## Shower Countdown Duration

Factory default “30 minutes”.

- ▶ Cycle menu to “F 9” and press “”.



- ▶ Press “+” or “-” to change the amount of time the shower will run before switching itself off.  
Adjustable between 1 - 30 minutes.



- ▶ Press “” to set.



- ▶ Press “” to exit back to Function Menu.  
See section “Exit the Function Menu”.



# REPLACING THE BATTERIES

To access the batteries, the control unit must be removed from the wall. Make sure control unit is **dry** before removing.

- ▶ Press button to release and remove control from wall.

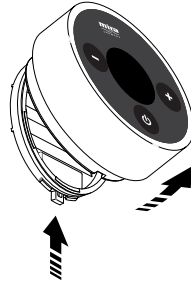

- ▶ Make sure the controller is dry before removing the battery cover. Turn unit over to remove the battery cover by loosening the 4 screws with a pozi drive screwdriver.

**Note!** The screws remain attached to the battery lid.

- ▶ Remove and replace all batteries. Make sure all 3 replacement batteries are of the same brand and type. Do not use rechargeable batteries.

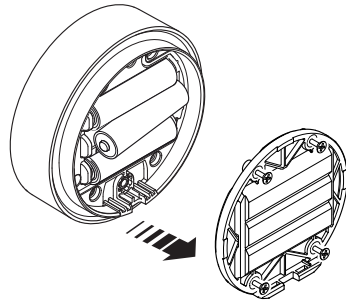

- ▶ Hook controller on top of backplate and push firmly until controller “clicks” back into place.

- ▶ If necessary, test shower to see if functions are working as expected.

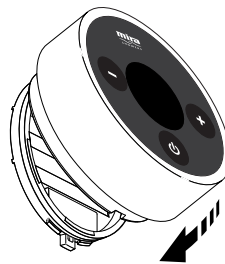

# FAULT DIAGNOSIS

## Error Codes

A specific problem relating to the electronic function of the shower will result in an error code being displayed on the control.

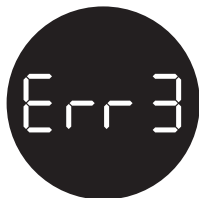

### Over Temperature at Control Sensor

1. Turn Digital Mixer off for 10 seconds. Turn back on and allow 15 seconds to reset.
2. If shower operation does not return to normal, make sure hot and cold inlets are not reversed.
3. If shower operation does not return to normal, make sure inlet filters and check valve cartridges are clean.



4. If shower operation does not return to normal, check the water supplies to the valve are within the correct temperature and pressure ranges. See "**Mira Platinum Installation Guide - Specifications**".
5. If problem still occurs, make a note of the error code and contact our Customer Services Team.



### Control Sensor

1. Turn Digital Mixer off for 15 seconds. Turn back on and allow 15 seconds to reset.
2. If shower operation does not return to normal, replace Thermistor. **(To be performed by competent tradesperson only!)**
3. If problem still occurs, make a note of the error code and contact our Customer Services Team.



#### Control Sensor or PCB Relay

1. Turn Digital Mixer off for 15 seconds. Turn back on and allow 15 seconds to reset.
2. If shower operation does not return to normal, replace Thermistor. **(To be performed by competent tradesperson only!)**
3. If shower operation does not return to normal, replace PCB. **(To be performed by competent tradesperson only!)**
4. If problem still occurs, make a note of the error code and contact our Customer Services Team.



#### Digital Mixer Temperature Motor

1. Turn Digital Mixer off for 15 seconds. Turn back on and allow 15 seconds to reset.
2. If shower operation does not return to normal, check and, if necessary, replace Mixer Valve. **(To be performed by competent tradesperson only!)**
3. If problem still occurs, make a note of the error code and contact our Customer Services Team.

### Error Code Number Not Previously Described



#### Digital Mixer PCB Error.

1. Turn Digital Mixer off for 15 seconds. Turn back on and allow 15 seconds to reset.
2. If problem still occurs, make a note of the error code and contact our Customer Services Team.



Replace batteries.





Control out of range.

### Error During Function Change



Displayed if there is a signal loss between the Wireless Control Unit and the Digital Mixer whilst a function setting is being altered. Press “⏻” to clear the display and retry the function change.

## General Faults

Malfunction	Cause	Remedy
No display.	The batteries are flat or incorrectly fitted.	Check and rectify.
Shower will not operate.  +   + 	Water supply isolated.  Flat batteries.  Electrical supply isolated or fuse blown.  No connection to Digital Mixer. Control out of range.  Digital Mixer malfunction.	Check water supply.  Replace batteries.  Check electrical supply. If fuse blown, replace Digital Mixer Valve PCB.  Reset and recommission. Refer to Installation Guide  Isolate electrical supply and reset after 30 seconds  If problem persists, contact our Customer Services Team.
No flow or low flow from Shower Fittings.	Showerhead blocked.  Stuck Checkvalve in Showerhead.  Hose blocked or twisted.  Digital Mixer malfunction.  "L" and or "H" values set too low in Flow Range (F6).	Check and clean.  Check and clear or replace Checkvalve.  Check and clean or release twist.  Contact our Customer Services Team.  Change to higher setting.
Drip from showerhead.	A small amount of water may be retained in showerhead after showering. This may drain over a few minutes.	This is normal. Changing position of showerhead may vary draining time.
Shower not hot enough.	Maximum showering temperature set too low.  Digital Mixer fitted incorrectly.	Increase maximum showering temperature (Function F1). Make sure hot and cold water supplies are connected correctly and delivering a constant flow and temperature within the required limits. See <b>"Specifications"</b> in the <b>"Mira Platinum Installation Guide"</b> .  If problem persists, contact our Customer Services Team.
Incorrect or fluctuating temperature.	Controller out of range.  Radio interference.  Warm up feature is being used with combi-boiler.	Refer to <b>"Fault Diagnosis"</b> in the <b>"Mira Platinum Installation Guide"</b> .  Disable Warm-Up feature. Refer to <b>User Guide - "Warm-Up"</b> .



Fluctuating or reduced flow.	Filters blocked. Water pressure too low. Flow rate is too low. Fluctuating water temperature.	Refer to “ <b>Fault Diagnosis</b> ” in the “ <b>Mira Platinum Installation Guide</b> ”.
Maximum blend temperature too hot or too cold.	Incorrect maximum temperature setting.	Refer to “ <b>Maximum Shower Water Temperature</b> ” in the “ <b>Mira Platinum Installation Guide</b> ”.
Continuous flow. Shower will not shut off.	Wireless Controller or Digital Mixer Valve failure.	Isolate power and water supplies. Contact our Customer Services Team.
Shower runs for a short time (30 - 60 seconds) then flow reduces, splutters or stops. Worst when other hot taps are in use. Less evident when shower is on full cold.	Air is being sucked down the vent pipe. (Gravity fed system).  Warm up setting inadvertently selected.	The hot draw off pipe is positioned too high in relation to the lowest water level of the cold water cistern (100 mm min, refer to “ <b>Gravity Fed Showers</b> ” diagram in the “ <b>Mira Platinum Installation Guide</b> ”. Consider increasing size of cold feed pipe to cylinder to 28 mm diameter.  Disable Warm-Up feature. Refer to ‘ <b>Function Menu</b> ’ - “ <b>Warm-Up</b> ”.
Shower runs for a short time (3 - 5 minutes)	Cistern capacity insufficient (230 litres minimum required). Eco setting selected.  “ <b>Shower Run Time</b> ” enabled.	Increase cistern size.  Disable Eco feature. Refer to ‘ <b>Function Menu</b> ’ - “ <b>Eco</b> ”.  Increase shower run time or disable feature. Refer to ‘ <b>Function Menu</b> ’ - “ <b>Shower Run Time</b> ”.
Shower runs cool after a short time (1 - 2 minutes) then flow splutters.	Air ingress into hot pipework.	Refer to plumbing system diagrams under “ <b>Installation</b> ” in the “ <b>Mira Platinum Installation Guide</b> ” for correct connection.
Shower runs cold after 5 - 10 minutes.	Insufficient storage of hot water in cylinder.	Increase storage of hot water.

# CLEANING

Many household cleaners contain abrasives and chemical substances, and should not be used for cleaning chrome plated or plastic fittings. These finishes should be cleaned with a mild washing up detergent or soap solution, and then wiped dry using a soft cloth.

# DISPOSAL AND RECYCLING

## End of Product Life

When the appliance has reached the end of its serviceable life, it should be disposed of in a safe manner and in accordance with current local authority recycling or waste disposal policy.

## Batteries

Spent batteries should not be disposed of with your normal household waste. Contact your local authority for information on waste disposal and recycling.



This symbol on the product or its packaging indicates that this product should not be disposed of with your other household waste. Instead, it is your responsibility to dispose of your waste equipment by handing it over to a designated collection point for the recycling of waste electrical and electronic equipment. The separate collection and recycling of your waste equipment at the time of disposal will help to conserve natural resources and ensure that it is recycled in a manner that protects human health and the environment. For more information about where you can drop off your waste equipment for recycling, please contact your local council office, your household waste disposal service or the shop where you purchased the product.

# NOTES

# CUSTOMER SERVICES

## Guarantee

Your product has the benefit of our manufacture's guarantee which starts from date of purchase. This guarantee only applies in the United Kingdom and Republic of Ireland. To activate this guarantee, please return your completed registration card, visit our website or free phone 0800 5978551 within 30 days of purchase (UK only).

Within the guarantee period we will resolve defects in materials or workmanship, free of charge, by repairing or replacing parts or product as we may choose.

**This guarantee is in addition to your statutory rights and is subject to the following conditions :**

- The guarantee applies solely to the original installation under normal use and to the original purchaser only. The product must be installed and maintained in accordance with the instructions given in this guide.
- Servicing must only be undertaken by us or our appointed representative.  
**Note!** If a service visit is required the product must be fully installed and connected to services.
- Repair under this guarantee does not extend the original expiry date. The guarantee on any replacement parts or product ends at the original expiry date.
- For shower fittings or consumable items we reserve the right to supply replacement parts only.

**The guarantee does not cover:**

- Call out charges for non product faults (such as damage or performance issues arising from incorrect installation, improper use, inappropriate cleaning, lack of maintenance, build up of limescale, frost damage, chemical attack, corrosion, system debris or blocked filters) or where no fault has been found with the product.
- Water or electrical supply, waste and isolation issues.
- Compensation for loss of use of the product or consequential or indirect loss of any kind.
- Damage or defects caused if the product is repaired or modified by persons not authorised by us or our appointed representative.
- Routine maintenance or replacement parts to repaired or modified by persons not authorised by comply with the requirements of the TMV2 or repaired or modified by persons not authorised by TMV3 healthcare schemes
- Accidental or wilful damage.
- Products purchased ex-showroom display.

## What to do if something goes wrong

If your product does not work correctly refer to this manual for fault diagnosis and check that it is installed and commissioned in accordance with our instructions. If this does not resolve the issue, contact us for help and advice.



### Helpdesk Service

Contact our Customer Services Team for product advice, to purchase spare parts or accessories or to set up service visit. You can contact us via phone or e-mail - contact details below.

Please provide your model name, power rating (if applicable) and date of purchase.



### Mira Showers Website

([www.mirashowers.co.uk](http://www.mirashowers.co.uk))

Visit our website to register your guarantee, download user guides, diagnose faults, purchase our full range of accessories and popular spares, or request a service visit.



### Spares and Accessories

We hold the largest stocks of genuine Mira spares and accessories. Contact us for a price or visit our website to purchase items from our accessory range and popular spares. (Only available in the United Kingdom )



### Service/Repairs

No one knows our products better than our nationwide team of Service Technicians. We can carry out service or repair work to your product both during and after the guarantee period. (Only available in the United Kingdom and Republic of Ireland) Ask about our fixed price service repairs.

**To Contact Us: UK**



**0844 571 5003**

Calls cost 7p per minute plus your phone company's access charge



**Fax: 01242 282595**



Email – Visit

[www.mirashowers.co.uk/contactus](http://www.mirashowers.co.uk/contactus)



By Post: **Mira Customer Services Dept, Cromwell Road, Cheltenham, Gloucestershire GL52 5EP**

**To Contact Us: Eire Only**



**01 531 9337**



E-mail:

[CustomerServiceEire@mirashowers.com](mailto:CustomerServiceEire@mirashowers.com)

*Mira is a registered trade mark of Kohler Mira Limited.*

*The company reserves the right to alter product specifications without notice.*



**mira**  
SHOWERS