

***mira***  
AZORA



## Mira Azora Thermostatic Electric Shower Installation & User Guide

These instructions are to be left with the user

# Contents

- Introduction ..... 3**
  - Patents and Design Registration..... 3
- Important Safety Information ..... 4**
- Pack Contents Checklist ..... 6**
- Specifications ..... 7**
  - 1. Plumbing ..... 7
  - 2. Electrical..... 7
  - 3. Standards and Approvals ..... 7
- Installation Requirements ..... 7**
  - 1. Plumbing ..... 7
  - 2. Electrical..... 9
- Installation ..... 10**
  - Installation of Mira Azora ..... 10
- Commissioning ..... 14**
- User Instructions ..... 16**
  - Using your Shower ..... 18
- Fault Diagnosis..... 19**
- Maintenance..... 22**
  - Handset - Cleaning..... 22
  - Inlet Filter - Cleaning/Renewing ..... 22
- Spare Parts ..... 24**
  - Mira Azora ..... 24
- Accessories ..... 24**
- Dimensions ..... 26**
- Wiring Diagram ..... 27**
- Notes ..... 28**
- Notes ..... 29**
- Notes ..... 30**
- Customer Services ..... 31**

## Introduction

Thank you for purchasing a quality Mira product. To enjoy the full potential of your new product, please take time to read this guide thoroughly. Having done so, keep it handy for future reference.

The Mira Azora is a thermostatic electric shower with separate controls for power selection and temperature/flow adjustment. A unique thermostatic valve stabilises temperature changes caused by water pressure fluctuations. These can result from taps being turned on or off, or a toilet being flushed. An individual light indicates “START/STOP”.

The Mira Azora comes complete with a set of Mira Energise Shower Fittings.

### Mira Azora 9.8 kW

A 9.8 kW 240 V AC (9.0 kW 230 V AC) heater with Mira Energise adjustable spray handset with four different spray actions (start, soothe, force and eco\*). Supplied complete with flexible hose, clamp bracket assembly, slide bar, supports, hose retaining ring and soap dish. Available in a satin chrome and glass finish.

\* The eco setting reduces the water flow to give economical use of water, whilst still giving an adequate shower performance. This setting performs best with most gravity, pumped, and mains pressure unvented systems. On electric showers and some combination boiler systems the economy setting will have no effect, and will give the same spray action as the start setting.

## Patents and Design Registration

Design Registration:	000578463-001-002
Patents:	GB: 2341667 Ireland: 82835
Patent Applications:	GB: 2 427 460, 2 428 286 Ireland: 2006/0462

If you experience any difficulty with the installation or operation of your new Electric Shower, please refer to ‘**Fault Diagnosis**’, before contacting Kohler Mira Ltd. Our telephone and fax numbers can be found on the back cover of this guide.

# Important Safety Information

Installation must be carried out in accordance with these instructions, and must be conducted by designated, qualified and competent personnel.

## 1. **Warning!**

Follow all warnings, cautions and instructions contained in this guide, and on or inside the appliance.

- 1.1. Products manufactured by us are safe and risk-free, provided that they are installed, used and maintained in good working order, in accordance with our instructions and recommendations.
- 1.2. Isolate the electrical and water supplies before commencing installation. The electricity must be turned off at the mains and the appropriate circuit fuse removed, if applicable.
- 1.3. Mains connections are exposed when the cover is removed.
- 1.4. Refer to the wiring diagram before making any electrical connections (refer to the wiring diagram at the back of this guide).
- 1.5. Make sure that any pipework that could become frozen is properly insulated.
- 1.6. Having completed the installation, make sure that the user is familiar with the operation of the appliance.
- 1.7. Make sure that this guide is left with the user.
- 1.8. **DO NOT** commission this appliance if water leaks from the unit or the heater tank pressure relief valve.
- 1.9. **DO NOT** fit any form of outlet control (e.g. Trigger handset) as the outlet acts as a vent for the tank body. Only Mira recommended outlet fittings should be used.
- 1.10. Make sure all electrical connections are tight, to prevent overheating.
- 1.11. **Warning! DO NOT** operate this appliance if it is frozen. Allow the appliance to thaw before using. The shower unit must not be fitted where it may be exposed to freezing conditions.
- 1.12. This product is not suitable for areas with high humidity (i.e steam rooms). Please consult your installer.
- 1.13. **THIS APPLIANCE MUST BE EARTHED. MAKE SURE SUPPLEMENTARY BONDING COMPLIES WITH THE "REQUIREMENTS FOR ELECTRICAL INSTALLATIONS".**

The installation must be in accordance with the current edition of 'The Plugs and Sockets etc. (Safety) Regulations' in force at the time of installation, this appliance is intended to be permanently connected to the fixed electrical wiring of the mains system.

## 2. Caution!

- 2.1. Read all of these instructions and retain this guide for later use.
- 2.2. The electrical installation must comply to “BS 7671 - Requirements for Electrical Installations”, commonly referred to as the IEE Wiring Regulations - Part 7, or any particular regulations and practices, specified by the local electricity supply company.
- 2.3. The plumbing installation must comply with the requirements of UK Water Regulations/Bye-laws (Scotland), Building Regulations or any particular regulations and practices, specified by the local water company or water undertakers.
- 2.4. Make sure that you fully understand how to operate this shower and make sure that it is properly maintained in accordance with the instructions given in this manual.
- 2.5. Anyone who may have difficulty understanding or operating the controls of any shower should be attended whilst showering. Particular consideration should be given to:
  - 2.5.1. The young.
  - 2.5.2. The elderly.
  - 2.5.3. The infirm.
  - 2.5.4. The disabled.
  - 2.5.5. Anyone who suffers from a medical condition that can result in temporary incapacity (e.g. epilepsy or blackouts).
  - 2.5.6. Anyone inexperienced in the correct operation of the controls.
- 2.6. Sunburn or skin conditions can increase your sensitivity to hot water. Make sure that you set the shower to a cooler temperature.
- 2.7. If any of the following conditions occur, isolate the electricity and water supplies and refer to “To contact us”, on the back page of this guide.
  - 2.7.1. If the cover is not correctly fitted and water has entered the appliance case.
  - 2.7.2. If the case is damaged.
  - 2.7.3. If the appliance begins to make an odd noise, smell or smoke.
  - 2.7.4. If the appliance shows signs of a distinct change in performance, indicating a need for maintenance.
  - 2.7.5 **DO NOT** operate this appliance if water leaks from this appliance.
- 2.8. When this appliance has reached the end of its serviceable life, it should be disposed of in a safe manner, in accordance with current local authority recycling, or waste disposal policy.

# Pack Contents Checklist

Tick the appropriate boxes to familiarise yourself with the part names and to confirm that the parts are included.

## Mira Azora



1 x Olive



1 x Compression Nut



3 x Fixing Screws



3 x Wall Plugs

1 x Mira Azora

## Documentation

- 1 x Installation Template
- 1 x Installer Checklist
- 1 x Guarantee Card

# Specifications

## 1. Plumbing

- Minimum maintained inlet pressure 70 kPa (0.7 bar).  
100 kPa (1.0 bar) recommended for satisfactory operation.
- Maximum static inlet pressure 1000 kPa (10 bar).
- Minimum static pressure 20 kPa (0.2 bar) to keep the inlet valve closed.

## 2. Electrical

- The Mira Azora 9.8 kW requires a 45 Amp fuse.
- The terminal block will accept cable up to 16 mm<sup>2</sup>.

## 3. Standards and Approvals

- The Mira Azora complies with all relevant directives for CE marking.

# Installation Requirements

## 1. Plumbing

- The appliance is designed to operate with a minimum maintained inlet pressure of 0.7 bar up to a maximum static inlet pressure of 10 bar.
- When installed in very hard water areas (above 200 ppm temporary hardness) your installer may advise the installation of a water treatment device, to reduce the effects of limescale formation. Your local water company will be able to advise the hardness of water in your area.
- It is recommended that a non-restrictive (free flowing) isolating valve is fitted in the cold water supply pipe to allow the complete maintenance of the appliance. Do not use a valve with a loose washer plate (jumper) as this can lead to a build up of static pressures.
- The appliance is suitable for installation within the shower area. It is fitted with a pressure relief device and must be positioned over a water catchment area with the controls at a convenient height for all users.
- The appliance must be fitted on to a finished flat and even wall surface (this wall surface should be tiled or waterproofed). **Do not** fit the appliance to the wall and tile up to the case. For safety requirements, an air gap must be left behind the appliance.

- Avoid layouts where the shower hose will be sharply kinked. This may reduce the life of the hose.
- A Hose Retaining Ring is supplied to prevent the handset from dropping below the spill-over level of the bath or shower tray, which could lead to contamination from back-siphoning. The supplied Hose Retaining Ring should meet the majority of user requirements for shower installations with flexible outlet fittings. However, there will be occasions when it will not provide a suitable solution. In these instances an outlet double checkvalve, e.g. a Mira DCV-H, **must** be fitted. This will increase the required supply pressure typically by 10 kPa (0.1 bar). Refer to section “Accessories”.
- Supply pipework **must** be flushed to clear debris before connecting to the appliance.
- To avoid damage to the case when soldered fittings are used, pre-solder the pipework and fittings before connecting them to the inlet connector assembly. Refrain from applying excessive force when making any connections. Always provide mechanical support when making the plumbing connections.
- The appliance is fitted with a brass inlet compression assembly for connecting to a 15 mm supply pipe from the top, bottom or back. Double checkvalves, if fitted in the inlet supply to the appliance, can cause a pressure build-up, which could exceed the maximum static inlet pressure and damage the appliance.

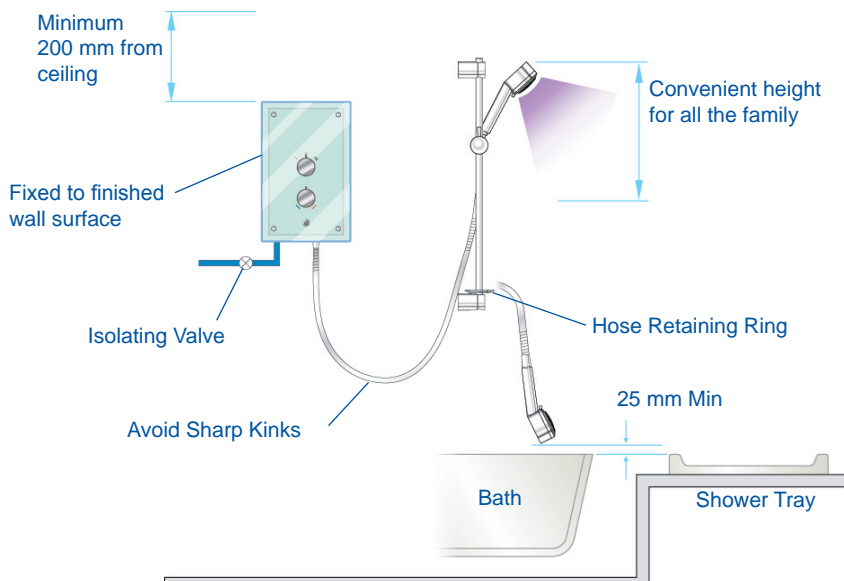



## 2. Electrical

- In a domestic installation, the rating of the electricity supplier's fuse and the consumer unit must be adequate for the additional demand. All Mira electric showers are high power units, it is essential to contact your electricity supplier to ensure that the supply is adequate for the product.
- Voltage drop due to local heavy demand will reduce the shower's performance.
- The appliance **must be earthed** by connecting the supply-cable earth conductor to the earth terminal.
- **Supplementary bonding:** Within the bathroom or shower room, all accessible conductive parts of electrical equipment and extraneous conductive parts (metal parts) that are likely to introduce earth potential, must be electrically bonded to earth using a minimum cable size of 4.0 mm<sup>2</sup> if the cable is not mechanically protected, (2.5 mm<sup>2</sup> if mechanically protected).
- The minimum cable size (cross-sectional area) required should be in accordance with BS 7671.
- As a guide only, and in accordance with BS 7671 we recommend close circuit protection: i.e. 9.8 kW = 45 Amp
- It is strongly recommended that a 30 mA Residual Current Device (RCD) is included in the electrical circuit. This may be part of the consumer unit or a separate unit.
- A separate, permanently connected supply must be taken from the consumer unit to the appliance through a double-pole switch, which has at least 3 mm of contact separation. The switch can be a ceiling mounted pullcord type within the shower room, or a wall mounted switch in an adjacent room.
- **DO NOT** twist the individual cable cores of either the live or neutral conductors, as this will prevent them from entering the terminal block.
- **DO NOT** exert strain on the terminal block. Ensure that the electrical connections are tightly screwed down.
- **DO NOT** turn-on the electrical supply until the plumbing has been completed.

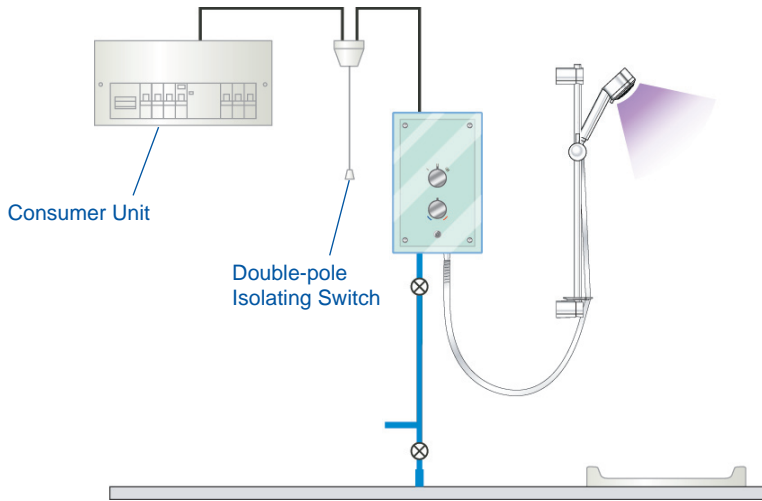

## Installation

### Installation of Mira Azora

▶ **Warning!** Turn off the electrical and water supplies before proceeding with the installation of the Mira Azora. The electricity must be turned off at the mains and the appropriate circuit fuse removed, if applicable.

▶ **Note!** An installation template is supplied to help you install the Mira Azora.

▶ Remove the three cover retaining screws and the cover.  
**Caution!** Handle the glass cover assembly with care.

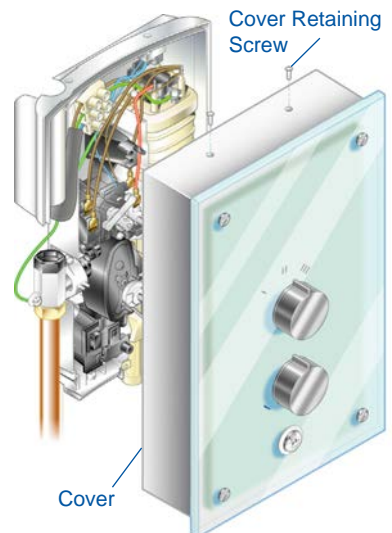

▶ Determine the direction of the inlet water supply: top (falling), bottom (rising), or back inlet .

▶ **Note!** Make sure that the back inlet does not go directly back into the wall. Use a soldered elbow.

▶ Swivel the inlet connector assembly to suit. Remove the inlet blanking cap. Avoid trapping the green earth bonding wire.

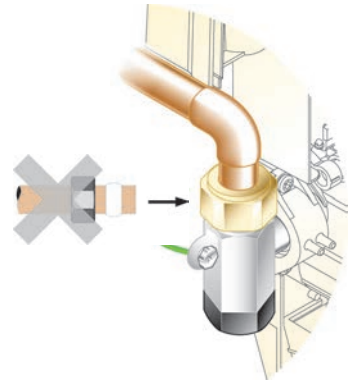

▶ Before fitting the Cover, make sure that the appropriate cutouts have been removed to suit the supply entering the product.

▶ **Thoroughly flush the mains-fed cold water supply pipe. The supply must be clean and free from debris BEFORE connecting the appliance.**

To flush the pipework, turn on the water supply and drain a minimum of 10 litres (2 gallons) of water into a bucket or catchment area. Turn off the water supply.

▶ An installation template is supplied to help you install the Mira Azora. Put the installation template on the wall and mark through the positions of the fixing holes. Ensure the position of these holes do not come in line with any buried cables or pipework. Make sure that sufficient electrical supply cable is available for connection to the terminal block.

▶ Drill and plug the top two fixing holes. Secure the appliance to the wall with the screws provided. Drill the bottom fixing hole with the product in place. Alternative fixings (not supplied) may be necessary for some wall structures. Avoid drilling into any supply cable/pipe.

▶ Install the mains-fed cold water supply pipe. Do not overtighten.

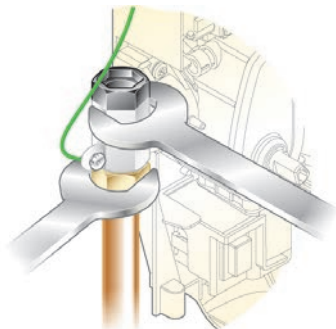

- ▶ Feed cable into Case. Fit Earth sleeve (not supplied) and then strip insulation. Do not twist cable cores.

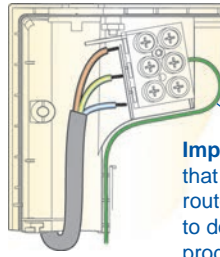

**Important!** Make sure that the inlet earth wire is routed as shown. Failure to do so may cause product malfunction.

- ▶ Firmly connect the conductors. Do not exert strain on the terminal.

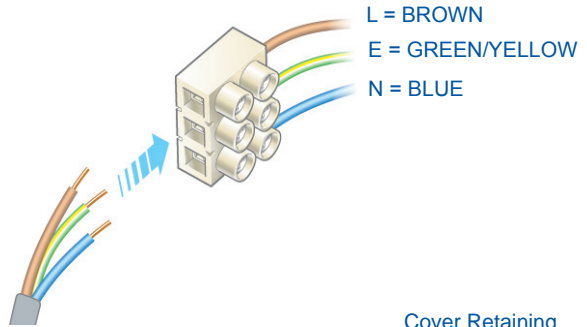

- ▶ Refit the Cover, making sure it is correctly located. Do not overtighten screws.

**Caution!** Handle the glass cover assembly with care.

Do not use alternative screws to secure the Cover. This can cause internal damage to the appliance.

Do not seal around the back of appliance.

When fitting the Cover, position the controls to correspond with the internal drive features as shown.

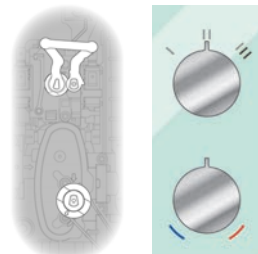
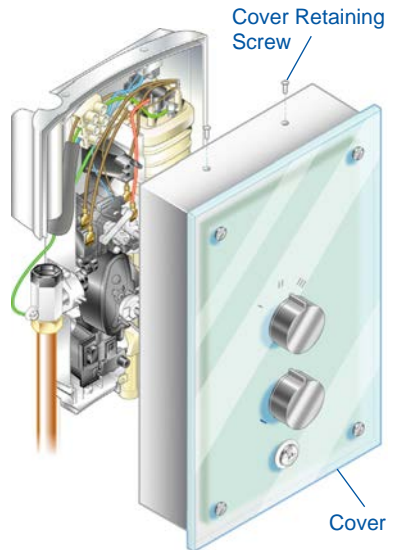

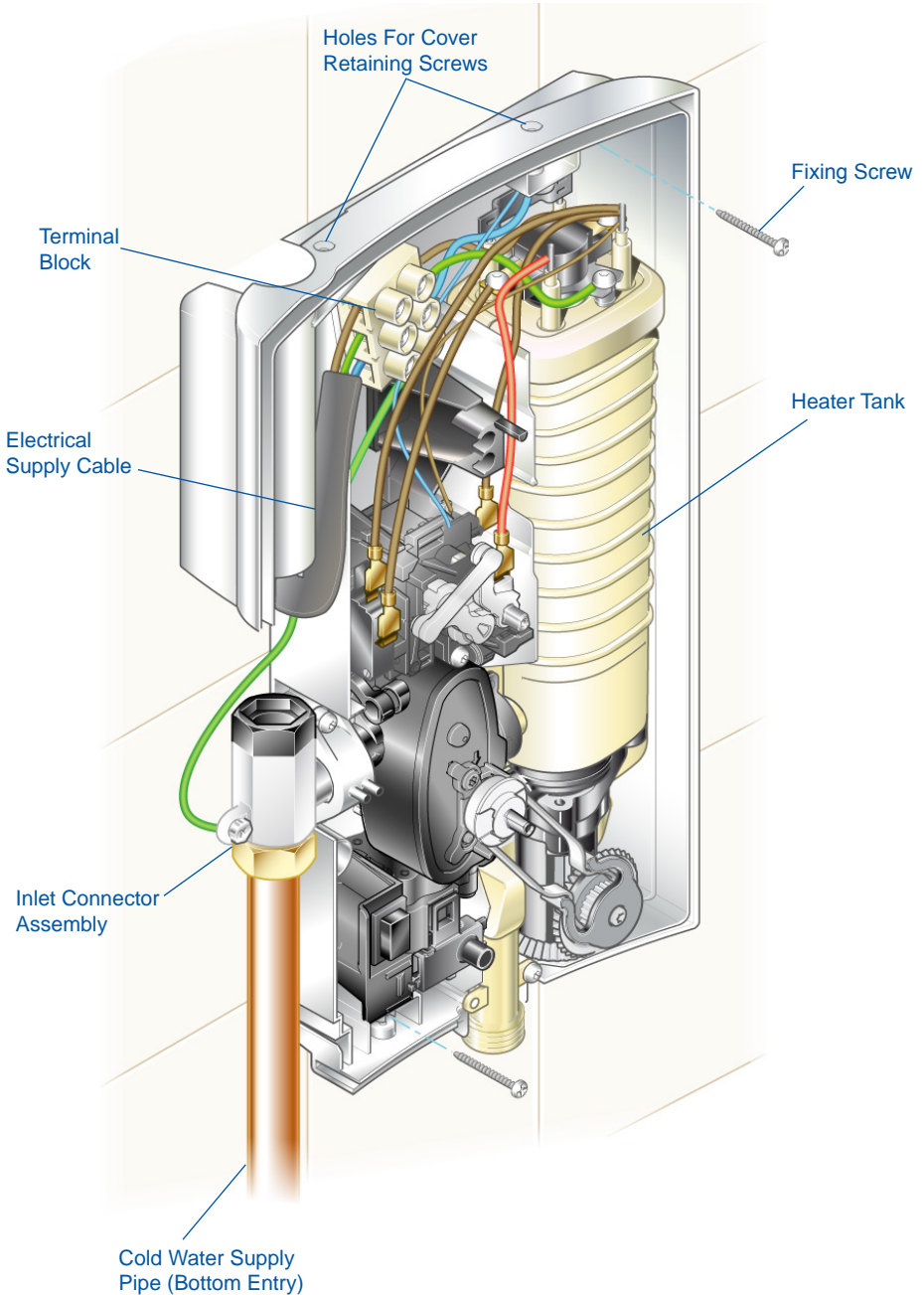

# Commissioning

Before carrying out the commissioning procedure install the Shower Fittings, refer to the Shower Fittings Installation and User Guide.

If you are unsure how an electric shower works, please read through the section “User Instructions” before continuing.

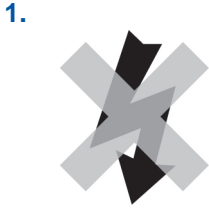

Electrical supply is turned off at the mains.

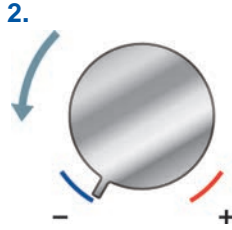

Turn control to full cold.

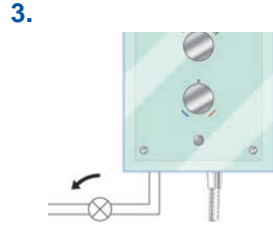

Turn the water supply fully on.

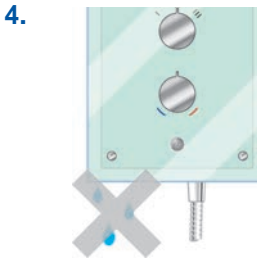

Check for water leaks.

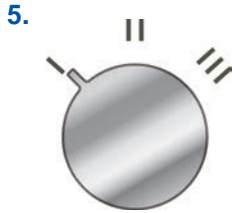

Set control to 'I'.

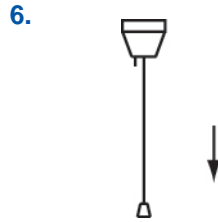

Switch on electrical supply.



Press the 'Start/Stop' button.

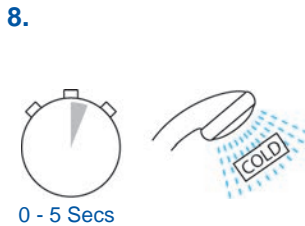

Water will be at full force and at a cool temperature.

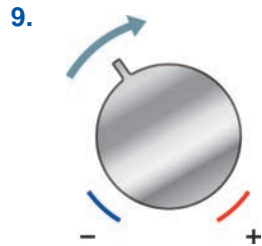

Turn the control slowly. Temperature remains cool and flow is reduced

10.

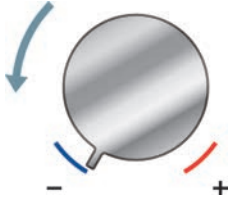

Turn control to full cold.

11.



Set control to 'II'.

12.



0 - 10 Secs

The temperature will rise slightly.

13.



Set control to 'III'.

14.



5 - 10 Secs

The temperature will rise further.

15.

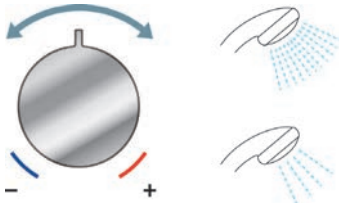

Adjust temperature as required.  
Flow rate will adjust automatically.

16.



Press STOP.

17.



Isolate power.

18.



0 - 5 Secs

The shower will purge from its tank for a few seconds.

19.



Residual water may drain over a few minutes.

**Note!** A slight hissing sound may be heard from the appliance during operation. High mains water pressure and high shower temperatures will affect the tone. This is quite normal in use.

# User Instructions

## How Your Electric Shower Works

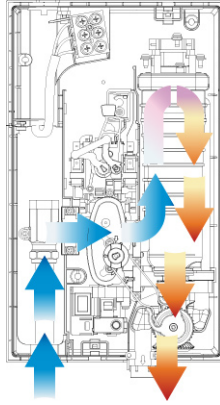

Heated water is produced by adjusting the flow of cold water passed through a heater tank.

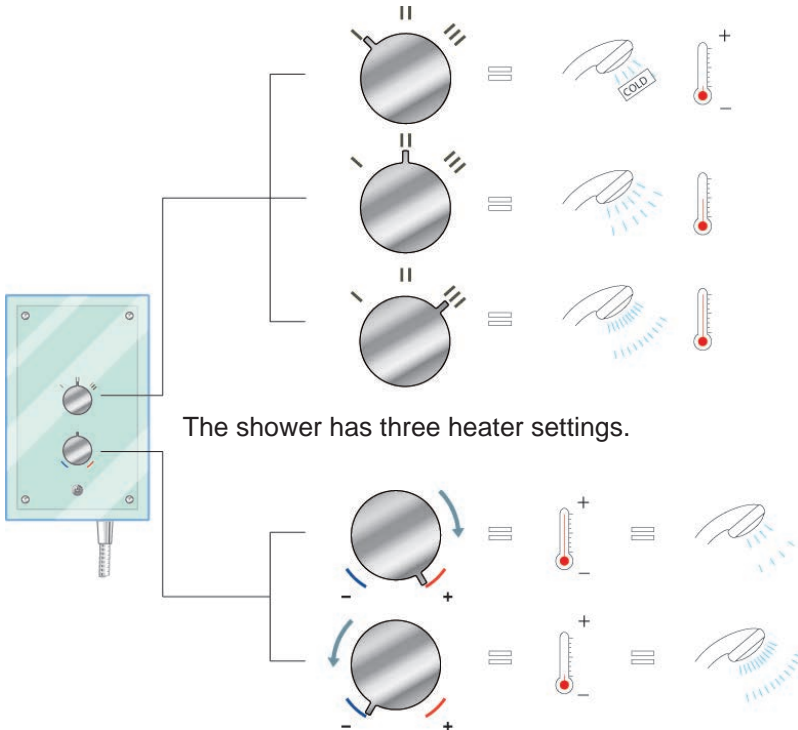

The shower has three heater settings.

The warmer the shower, the lower the flow rate and vice versa.



## The Effect of Seasonal Changes

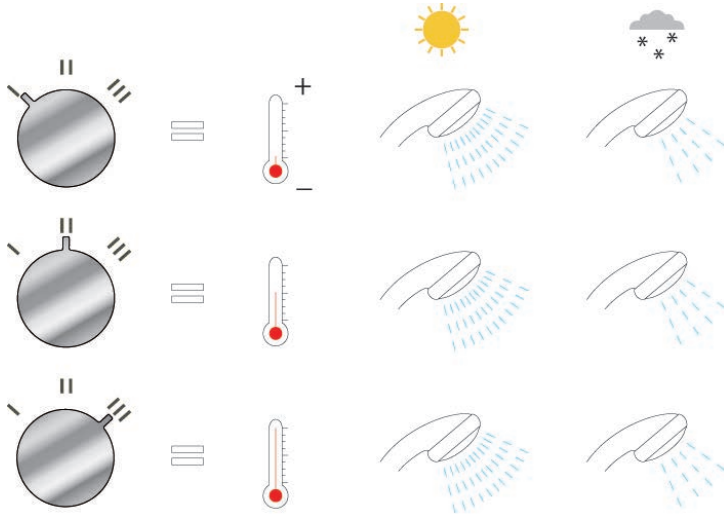

For a cold shower select I.

For a summer warm shower select II.

For a winter warm shower select III.

During extremes of mains water supply temperature, adjust heater setting to obtain a better showering temperature.

## The Effect of Other Water Devices

Example of how shower temperature stabilises due to pressure changes.

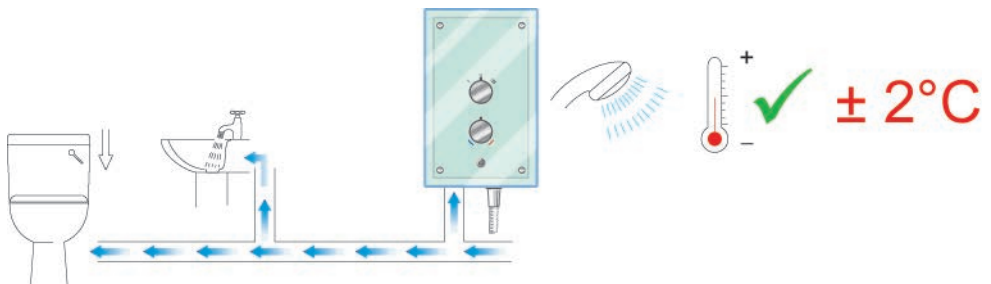

Water inlet pressure fluctuations due to other draw offs (e.g. flushing toilet). Shower temperature will be controlled to within  $\pm 2^{\circ}\text{C}$  of the set temperature provided that the supply conditions remain within the required operating parameters (refer to section: '**Specifications**').

# Using your Shower

Read the section “**Important Safety Information**” first.

1.



Switch on electrical supply.

2.



Press the ‘Start/Stop’ button.

3.



Set to desired position.

4.



Check water temperature before entering shower.

5.



Allow 10 - 15 seconds for any temperature adjustments to reach the handset.

6.



Press STOP button. Shower will continue to run for a few seconds before stopping.

7.



Isolate power.

8.



Residual water may drain over a few minutes.

**Note!** At the end of every shower make sure that the shower head points into the catchment area. A small amount of water may be retained in the shower handset after the shower has been turned off. This may drain over a few minutes.

## Fault Diagnosis

The trouble shooting information tabled below gives details on probable causes and remedies should difficulties be encountered whilst the shower is in operation.

**Warning!** There are no user serviceable components beneath the cover of the appliance. **Only a competent tradesperson should remove the front cover!**

Symptom	Start/ Stop Light	Heater Setting I/II/III	Probable Cause	Possible Remedy
Appliance Fails to operate	OFF	Any	Electrical supply isolated at double pole switch.	Switch on electrical supply via the pullcord or wall mounted switch.
	OFF	Any	Fuse blown or MCB/RCD tripped, indicating possible electrical fault.	Renew the fuse or reset the MCB/RCD. If fault persists, contact your installer.
Shower cycles from hot to cold	ON	II/III	Handset blocked.	Remove and clean.
	ON	II/III	Water pressure below minimum required for appliance operation.	Make sure incoming mains water stopcock and/or appliance isolating valve is fully turned on.
	ON	II/III	Temperature dial or Heater setting too high.	Turn the heater selector knob to setting II or turn the temperature control until a cooler temperature is achieved.
	ON	II/III	Thermostatic mechanism is faulty or damaged.	Replace.
Unable to select a cool enough shower.	ON	III	Due to the rise in mains water supply temperature, the Heater setting may be too high.	Turn the heater selector knob to II and adjust the temperature control until a suitable temperature is achieved.

**All the following remedies must be performed by a competent tradesperson.**

Handset dripping	OFF	Any	Insufficient water supply pressure for shut off.	The minimum static pressure to ensure shut off and prevent dripping is 0.2 bar. <b>Note!</b> If other appliances are operating, static pressure may drop below 0.2 bar. Contact local water company. Renew the Flow Valve.
	OFF	Any	Inlet valve faulty.	Replace.

Symptom	Start/Stop Light	Heater Setting I/II/III	Probable Cause	Possible Remedy
Low or no flow.	ON	Any	Water supply pipework or inlet filter restricted by a blockage or partial blockage.	Flush supply pipe. Clean inlet filter.
	ON	Any	Insufficient water supply pressure/flow for operation.	Contact local water company. Supply pressure must be a minimum of 0.7 bar. Note: If other appliances are operating, pressure may drop below 0.7 bar.
	ON	Any	Other outlets (e.g. toilet, garden hose, washing machine, etc.) drawing water while the shower is being used.	Turn off other appliances whilst shower is in use.
	ON	Any	Handset blocked.	Remove and clean.
	OFF	Any	Service tunnel or cover not fitted correctly causing Start/Stop button not to operate.	Check case inserts are cut and fitted correctly. Check services (electrical or plumbing) are not interfering with location of service tunnel or cover.
	ON	Any	Inlet Valve faulty.	Replace.
	ON	Any	Heater Tank excessively scaled.	Replace. In hard water areas consider the use of a water softener.
Operation of temperature control has little or no effect on water temperature.	ON	II/III	Handset or inlet filter blocked.	Remove and clean.
	ON	II/III	Inlet valve faulty.	Replace.
	ON	II/III	Heater tank failure.	Replace.
	ON	II/III	Microswitch failure.	Replace.
No change in temperature between I/II/III settings.	ON	Any	Insufficient mains water pressure.	Contact local water company.
	ON	Any	Possible failure of flow valve, microswitch or heater tank.	Check the continuity of the microswitch or heater tank and replace parts as necessary.

Symptom	Start/Stop Light	Heater Setting I/II/III	Probable Cause	Possible Remedy
Water will not turn off.	ON	Any	Inlet valve, solenoid, or start/stop switch faulty.	Replace as necessary.
	ON	Any	Supply pressure below 0.2 bar.	Contact local water company. Check mains water static pressure.
Appliance fails to produce hot water when set on II/III heater settings.	ON	II/III	Insufficient water supply.	Contact local water company.
	ON	II/III	Possible failure of the microswitch or thermal switch.	Check the continuity of the microswitch or heater tank and replace parts as necessary.
	ON	II/III	Heater Tank failure.	Replace.

# Maintenance

## Handset - Cleaning

- ▶ Clean with mild washing up detergent or soap solution. Wipe dry with a soft cloth.
- ▶ Poor shower performance can be avoided by cleaning the spray plate. Use thumb or soft cloth to wipe rubber nozzles. The handset must be descaled regularly.



## Inlet Filter - Cleaning/Renewing

Read the section “**Important Safety Information**” first

- ▶ Make sure that the electrical supply is turned off at the mains and that the water supply is fully turned off.
- ▶ Remove the three screws and the cover.  
**Caution!** Handle the glass cover assembly with care.

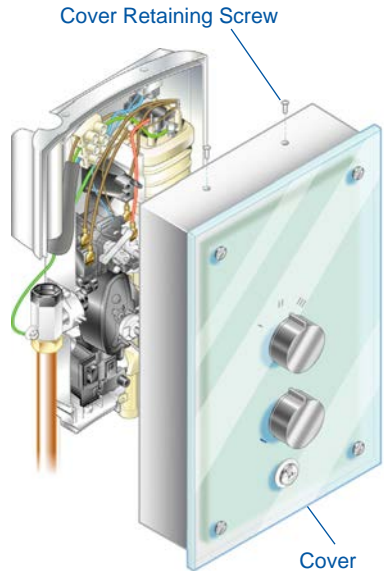

- ▶ Hold a wrench across the flats of the metal connector. Unscrew the filter using another wrench as shown. Clean or renew the Filter as necessary. Refit in reverse order making sure the Filter is screwed fully home.

**Do not overtighten!** Make sure plumbing connections are sealed before restoring electricity supply.

- ▶ Refit the Cover making sure it is correctly located. Do not overtighten the screws.

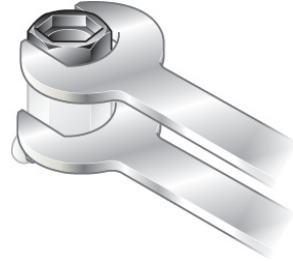
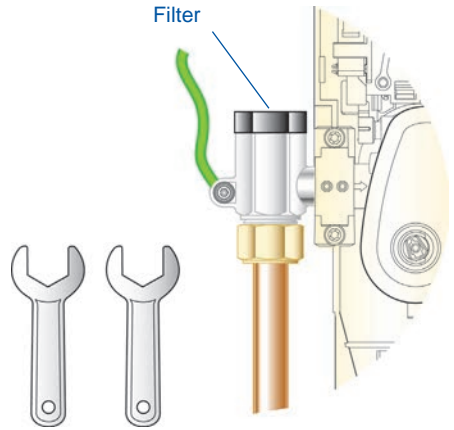

# Spare Parts

## Mira Azora

405.58	Inlet Connector Assembly
406.27	Inlet Filter (with 'O' seal fitted)
416.38	Clamp Bracket (Inlet)
416.41	Thermal Switch
416.48	Latching Switch
416.51	Solenoid Coil
872.01	Microswitch N/O - 2 pin
872.28	Microswitch C/O - 3 pin
1563.519	Terminal Block Assembly
1563.533	Thermostatic Valve/Heater Tank 9.8 kW 240 V AC
1563.534	Outlet Connector Assembly
1563.537	Temperature Control Belt Thermostatic
1563.538	Temperature Cam & Pulley
1563.539	Switching Assembly
1563.540	Inlet Valve Assembly
1563.551	Component Pack - chrome - components identified 'B'
1634.009	Cover Assembly
1634.015	Start/Stop LED Assembly
1634.026	Screw Pack - components identified 'A'

## Accessories

DCV-H: An outlet double check valve, designed to prevent the backflow or backsiphonage of potentially contaminated water, through shower controls which are fitted with a flexible hose as part of the outlet shower fitting. Available as an optional accessory from your Mira Showers stockists.





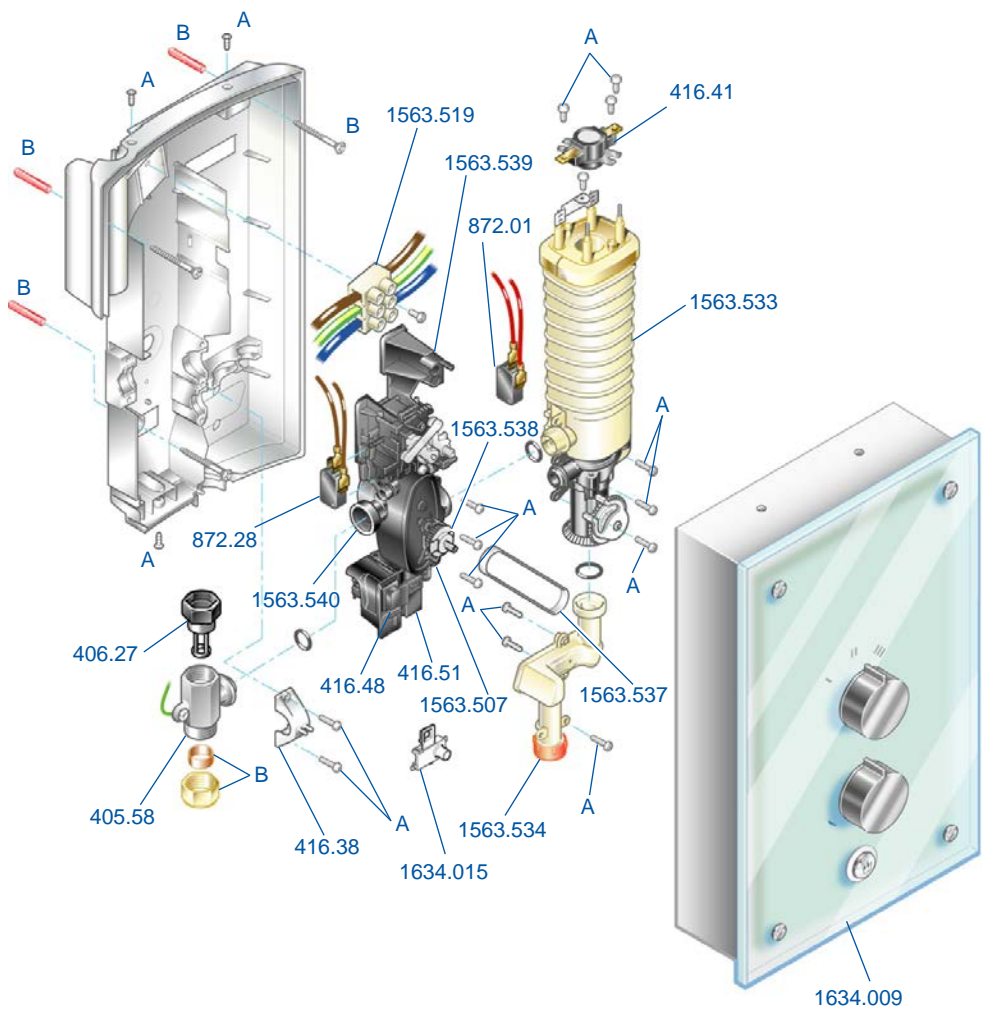

# Dimensions

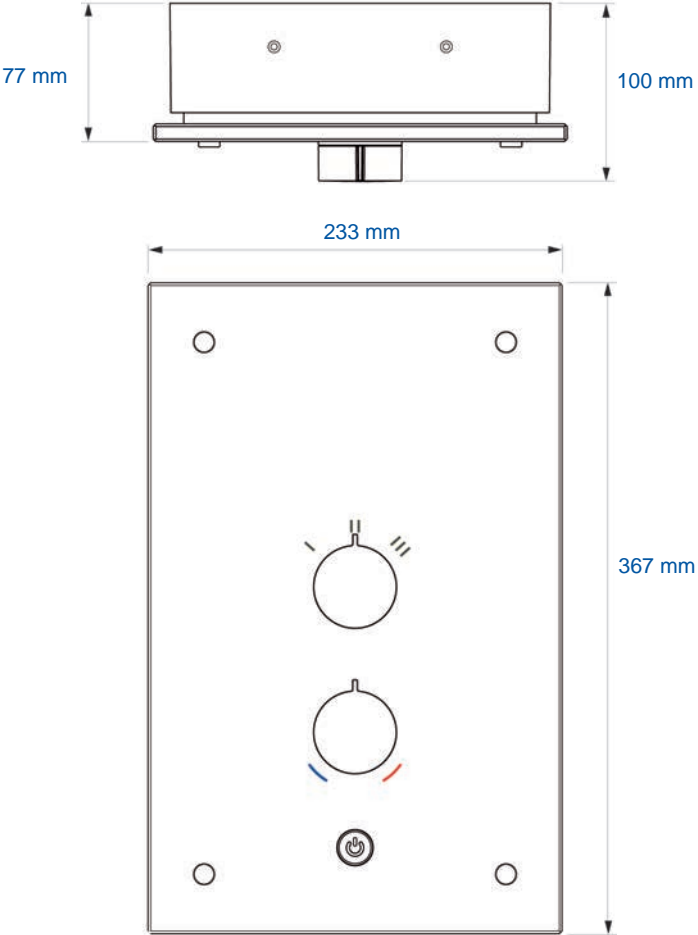

# Wiring Diagram

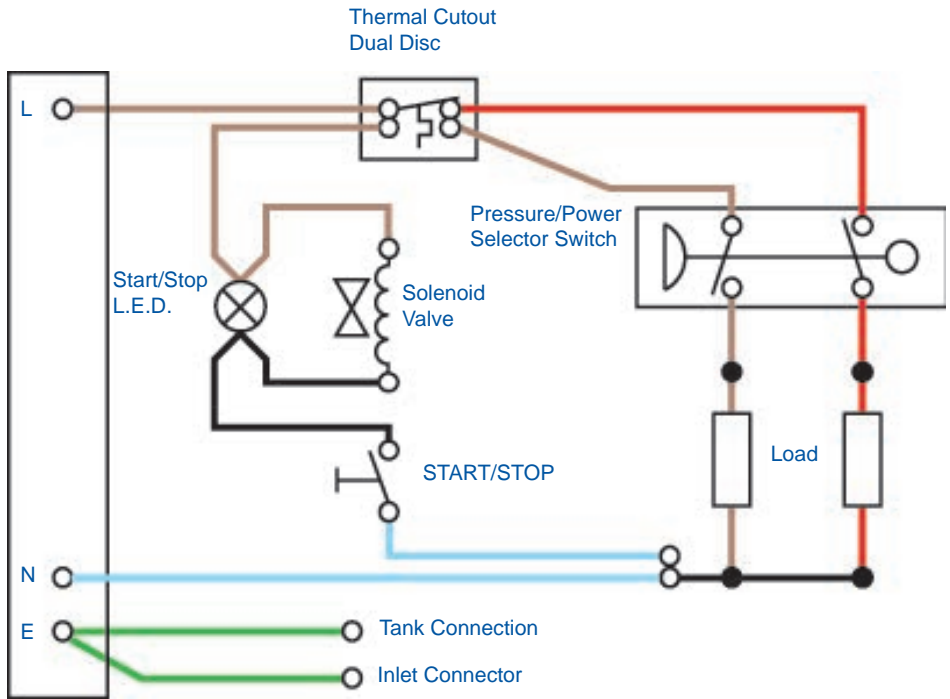

Internal Wiring Diagram

# Notes

# Notes

## Notes

# Customer Services

## Guarantee of Quality

Mira Showers guarantee your product against any defect in materials or workmanship for the period shown in the Guarantee Registration Document included with your shower.

Alternatively, to confirm the applicable guarantee period please contact Customer Services.

To validate the guarantee, please return your completed registration card.

Within the guarantee period we will resolve defects, free of charge, by repairing or replacing parts or modules as we may choose.

To be free of charge, service work must only be undertaken by Mira Showers or our Approved Agents in Northern Ireland and the Republic of Ireland.

Service under this guarantee does not affect the expiry date. The guarantee on any exchanged parts or product, ends when the normal product guarantee period expires.

## Not covered by this guarantee

Damage or defects arising from incorrect installation, improper use or lack of maintenance, including build-up of limescale.

Damage or defects if the product is taken apart, repaired or modified by any person not authorised by Mira Showers or our Approved Agents.

This guarantee is in addition to your statutory and other legal rights.

## Before using your shower

Please take the time to read and understand the operating and safety instructions detailed in this manual.

## What to do if something goes wrong

If when you first use your shower and it doesn't function correctly, first contact your installer to check that the installation and commissioning are satisfactory and in accordance with the instructions in this manual.

Should this not resolve the difficulty, simply contact our Customer Services who will give every assistance, and if necessary arrange for our Service Engineer to visit.

If later the performance of your shower declines, consult this manual to see whether simple home maintenance is required. Please call our Customer Services to talk the difficulty through, request service under guarantee if applicable, or take advantage of our comprehensive After-Sales Service.

As part of our quality and training programme calls may be recorded or monitored.

Our Customer Services Team is comprehensively trained to provide every assistance you may need: help and advice, spare parts or a service visit.

## Spare Parts

We maintain an extensive stock of spares, and aim to have functional parts available for ten years from the date of final manufacture of the product.

Spares can be purchased from approved stockists or merchants (locations on request) or direct from Customer Services.

Spares direct will normally be despatched within two working days. Payment can be made by Visa or Mastercard at the time of ordering. Should payment by cheque be preferred a pro-forma invoice will be sent.

**Note!** In the interests of safety, spares requiring exposure to mains voltages can only be sent to competent persons. Service

Our Service Force is available to provide a quality service at a reasonable cost. You will have the assurance of a Mira trained Engineer/Agent, genuine Mira spares and a 12 month guarantee on the repair.

Payment should be made directly to the Service Engineer/Agent, using Visa, MasterCard or a cheque supported by a banker's card.

## To contact us

England, Scotland, Wales & Northern Ireland

### Mira Showers Customer Services

Telephone: 0870 241 0888  
Mon. to Fri. 8:00 am to 5:30 pm  
8:30 am to 3:30 pm Saturday  
technical@mirashowers.com  
E-mail:  
Fax: 01242 282595  
By Post: Cromwell Road, Cheltenham,  
Gloucestershire, GL52 5EP

Republic of Ireland

### Modern Plant Ltd. (Dublin)

Telephone: 01 459 1344  
Mon. to Fri. 9:00 am - 5:00 pm  
sales@modernplant.ie  
E-mail:  
Fax: 01 459 2329  
Post: Otter House, Naas Road,  
Clondalkin, Dublin 22

### Modern Plant Ltd. (Cork)

Telephone: 021 496 8755  
Mon. to Fri. 9:00 am - 5:00 pm  
cork@modernplant.ie  
E-mail:  
Fax: 021 496 8607  
Post: Tramore Road, Cork



**Mira Showers**  
Kohler Mira Ltd  
Cromwell Road,  
Cheltenham GL52 5EP.

Mira is a registered trade mark of  
Kohler Mira Limited.  
The company reserves the right to alter  
product specifications without notice.  
[www.mirashowers.com](http://www.mirashowers.com)





## **Check out our full range of Showers**

Electric Showers

Digital Showers

Mixer Showers

Power Showers

Smart Showers

Shower Towers

## **From Top Shower Brands**

Mira Showers

Aqualisa Showers

Triton Showers

Gainsborough Showers

## **Shower Pumps can upgrade your showering experience even more**

Stuart Turner Shower Pumps

Salamander Shower Pumps

Grundfos Shower Pumps

**plumbworld**  
**Big brands, small prices.**