

Important information

Please check the construction set for completeness using the position list in good time before starting construction or commissioning your construction team. If individual parts are defective or missing, we will deliver these as quickly as possible. However, we cannot refund the costs for any resulting construction delays to a construction company.

Please understand that we cannot assume any guarantee for the following defects:

- incorrect storage before assembly
- incorrect anchoring with the ground or inadequate foundation (foundation according to statics)
- damage due to erection errors, e. g. the house is not level or not right-angled
- damage through a higher level of snow burden than statically envisaged. Recommendation: load relief of the roof by removing the snow layer
- storm damage (insurance cases) or violent destruction
- damage through any alteration to the design by the client
- natural formation of cracks, branch holes, twisting, decolouration or similar modification (natural process; has no influence on the statics)

Storage information until construction:

- store pallet on a level and dry surface.
- Protect from exposure to sunlight and the influences of weather; wood can warp drastically in a loose condition!





Maintenance tips:



The wood is untreated. Accordingly, regular, protective coating is absolutely necessary! Please observe the attached information sheet "Care instructions/Colour treatment".

General tips and refers to:



-  1 - The packaging foil **can be used** to keep moisture out of the house. It is laid according to the ground area of the house under the main bearing (not in delivery).
-  1 - **Foundation according to the structural calculations** (not included in the scope of delivery): concrete C25/30, each 2 Ø 12 top and bottom, brace mat R188A (alternatively brace Ø 6/20cm). Anchoring of the floor beams **(in the building)** on the strip foundation using bolts M12, e ≤ 60cm. The base bearings in the storeroom of the house must be entirely flush.
-  2 - **It is necessary to lay a tarpaper or equal on the roofboards.**
-  3 - Please note, that the screw with the washer has to **fasten on the top of the longholes in the strip for connecting the planks together**. It is important, that the screws **can move a little bit** and the roof doesn't come into contact with these connecting strips; **otherwise you have to cut these strips on the bottom. Please don't screw too tight.**



Garden Studio 330 x 210cm

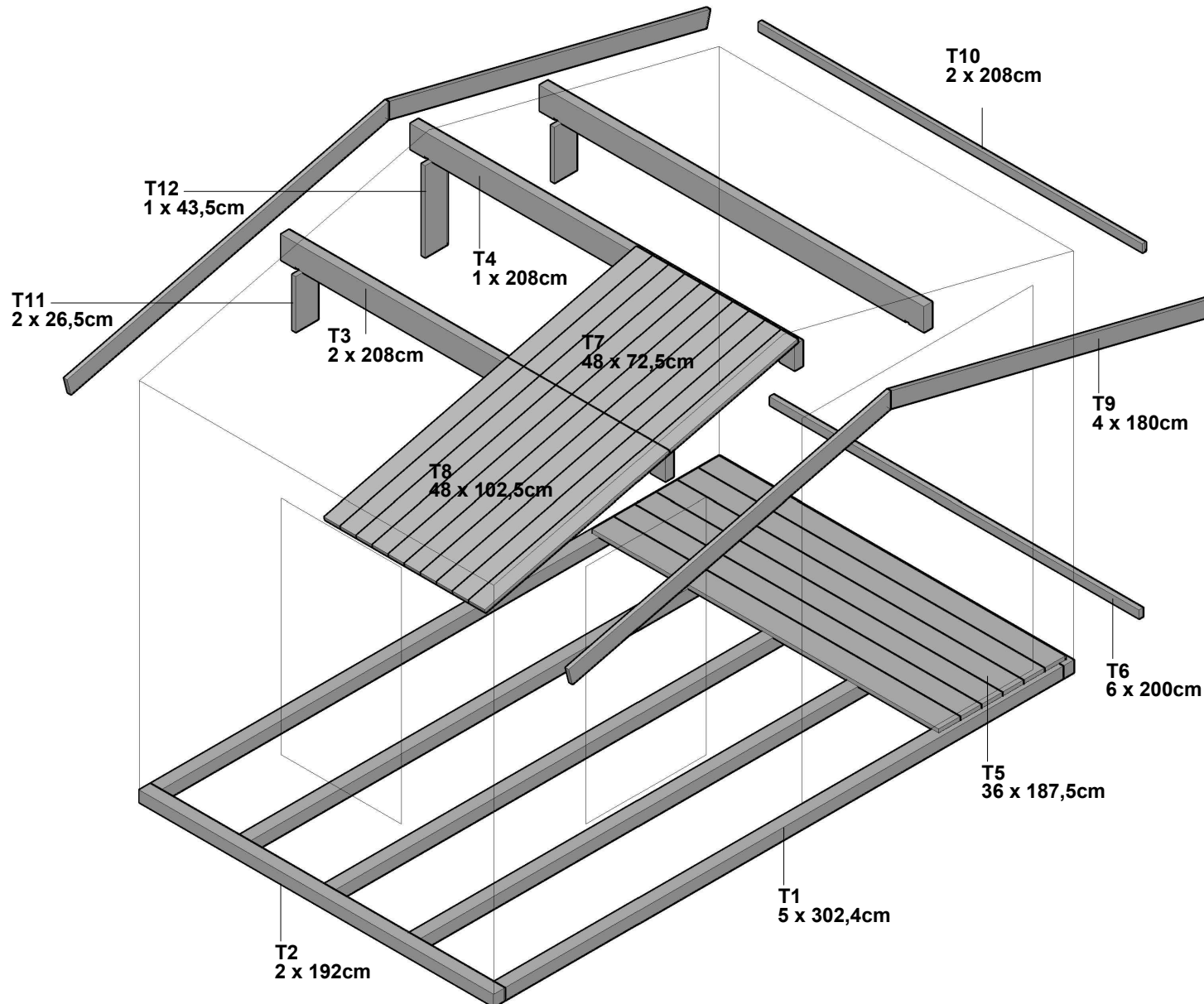

- 6 x B100
- 350 x B115-050 50mm
- 24 x B105-020 20mm
- 20 x B105-030 30mm

- 16 x A108-24
- 40 x B105-035 35mm
- 350 x B105-040 40mm
- 36 x B105-050 50mm
- 4 x B105-060 60mm
- 12 x B105-080 80mm
- 10 x B105-100 100mm

- 4 x T13

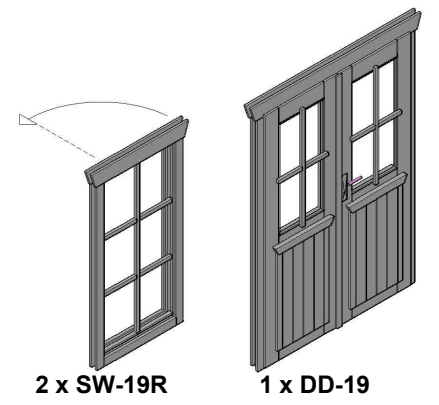



Garden Studio 330 x 210cm



3

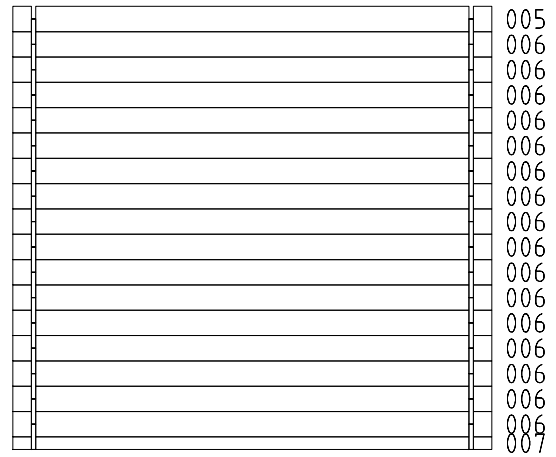
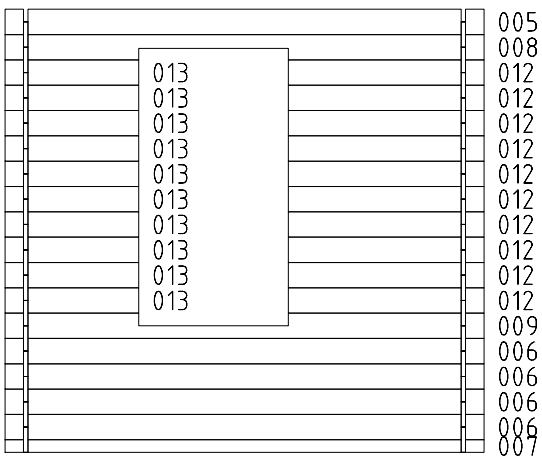
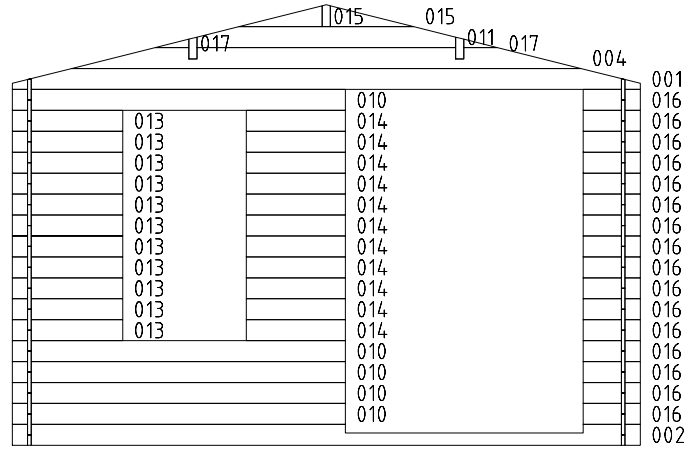
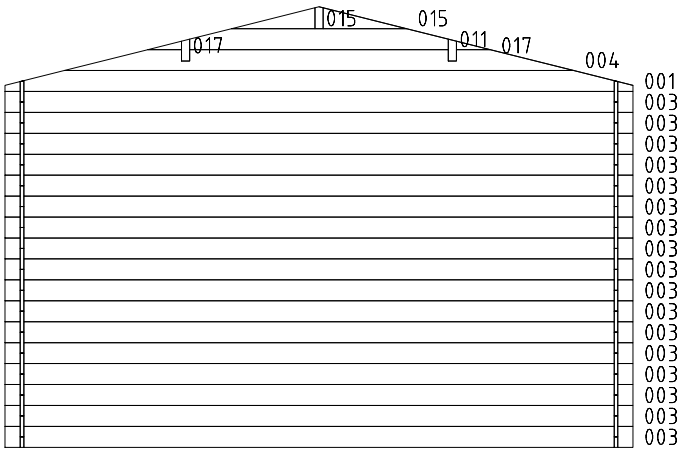

Zusätzlich / adicional:

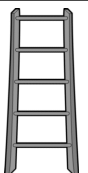
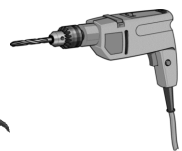
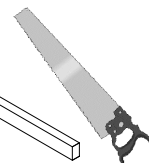
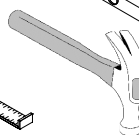
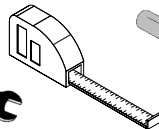
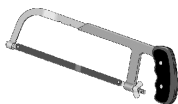



Garden Studio 330 x 210cm



4

1

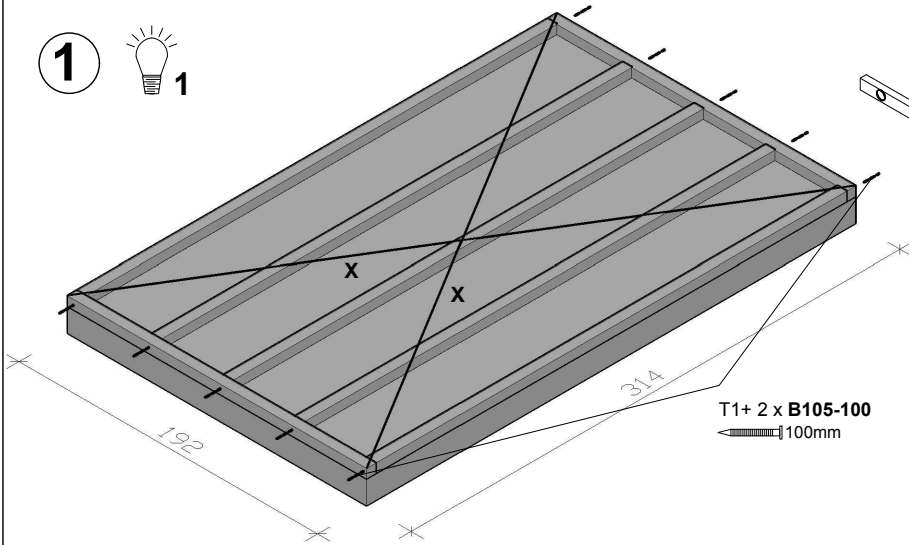

T1+ 2 x B105-100
100mm

!!! X=X

1.1 o

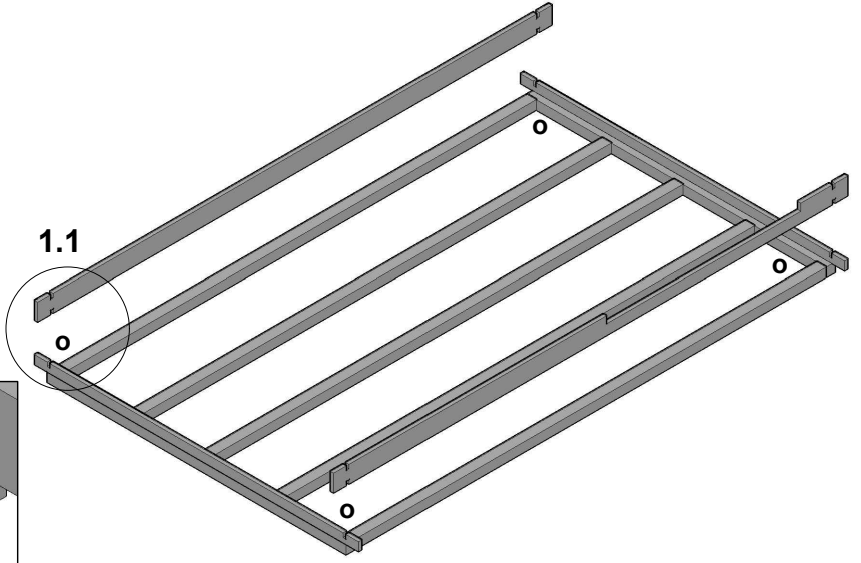
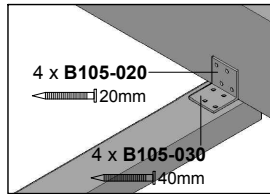
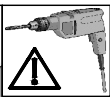
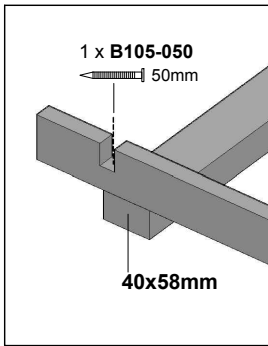

2

2.1

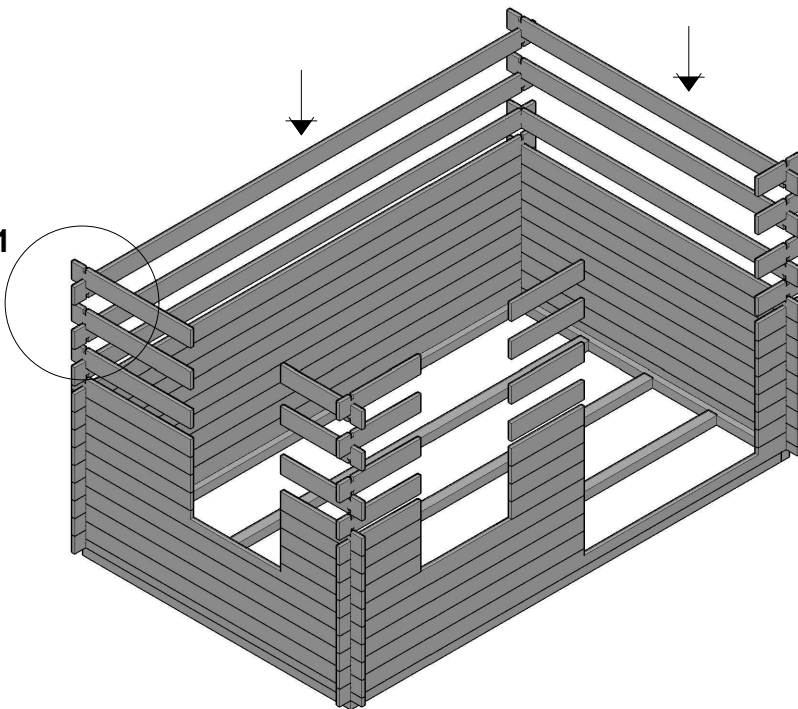

2.1

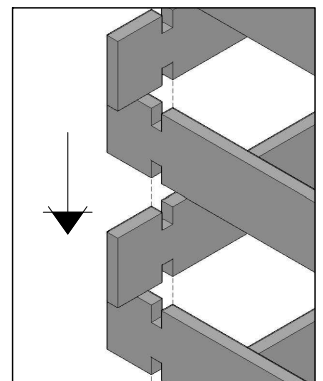



Garden Studio 330 x 210cm



3

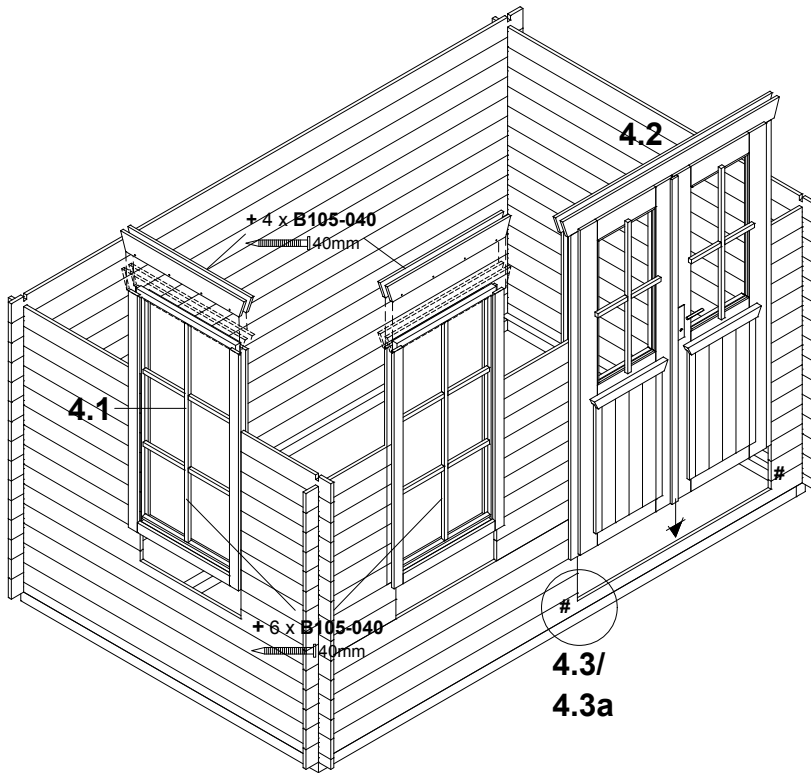

5

4.1

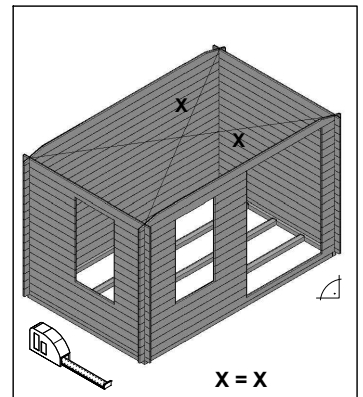
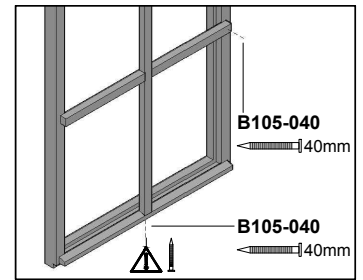

4

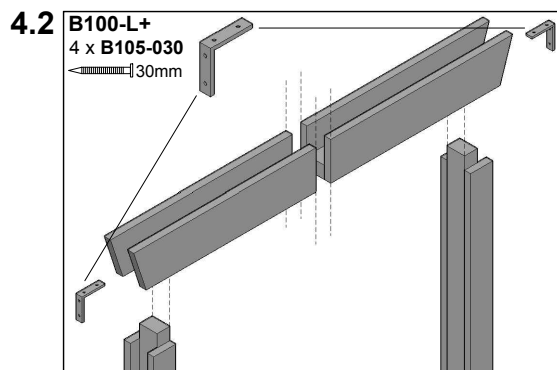

- Hang the doorleaf on the hinges **after** pushing the frame into position

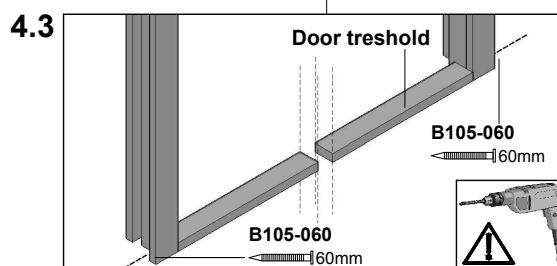

4.3a #

- inside

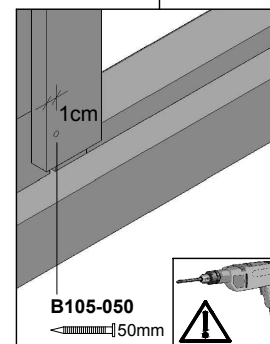



Garden Studio 330 x 210cm



5

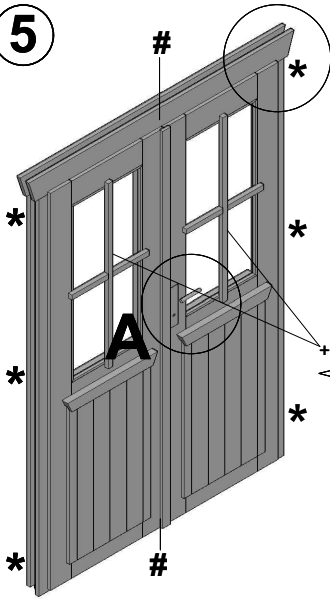

B

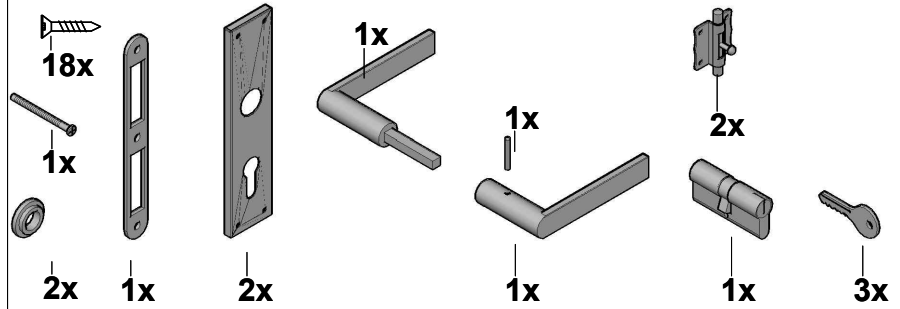

6

A

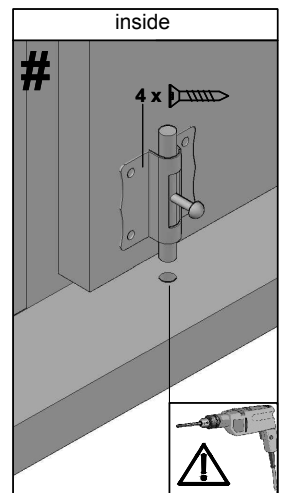
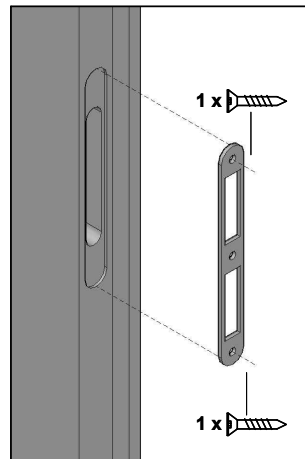
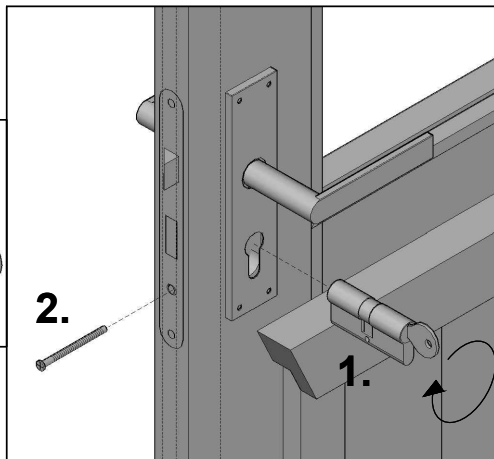
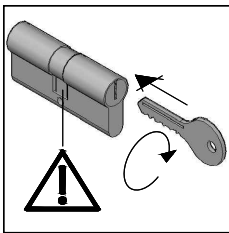
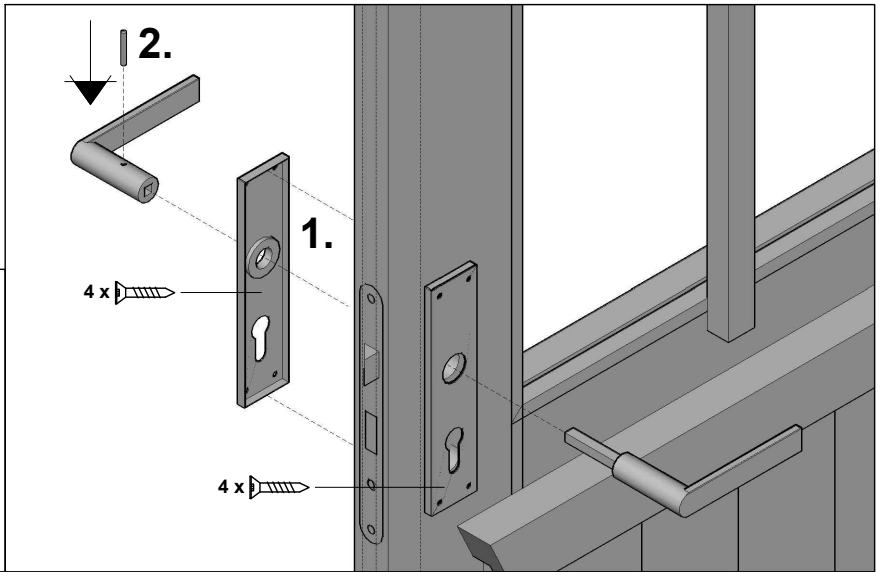
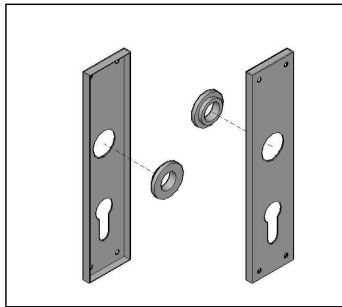

B

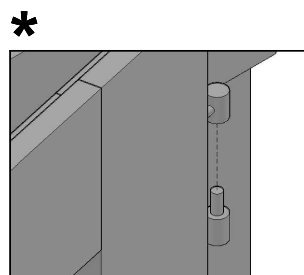

2

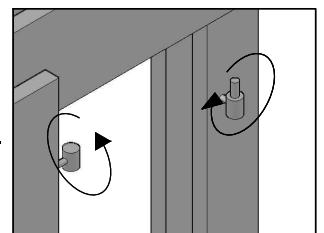



Garden Studio 330 x 210cm



7

5

5.1

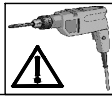

1. 2 x B105-080
80mm

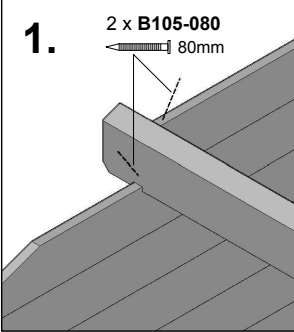

5.1

T11+T12 +
8 x B105-035
35mm

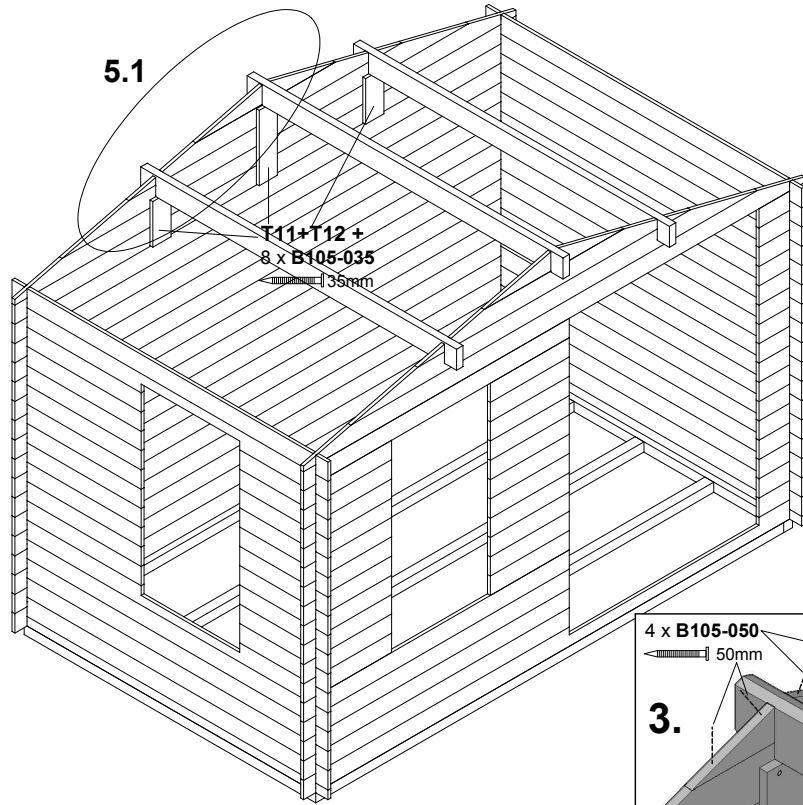

5.1

2. 2 x B105-080
80mm

3 x B105-050
50mm

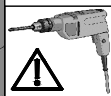
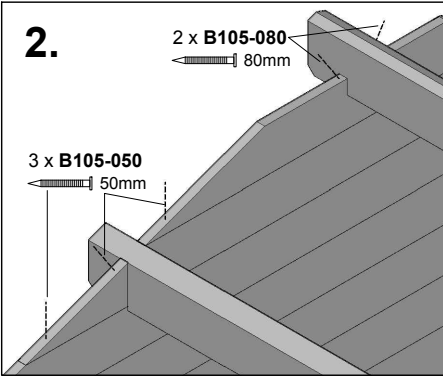

5.1

3. 4 x B105-050
50mm

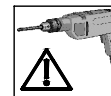
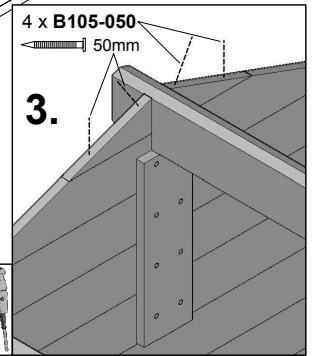

6

6.1

T7+2 x B105-040
40mm



6.1

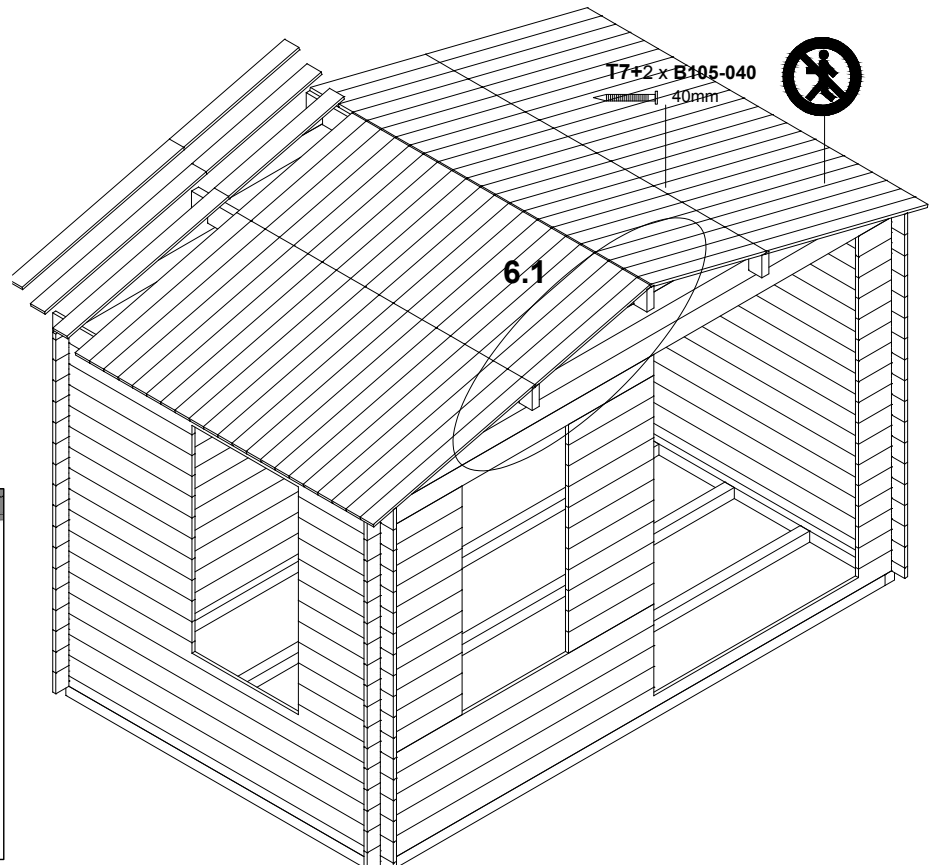
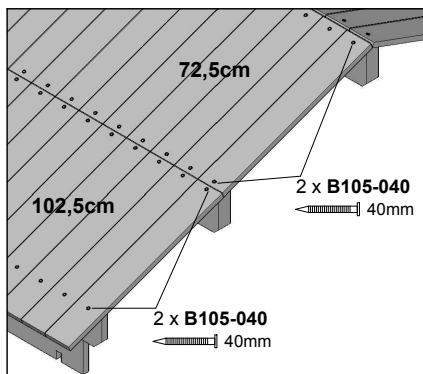



Garden Studio 330 x 210cm



7

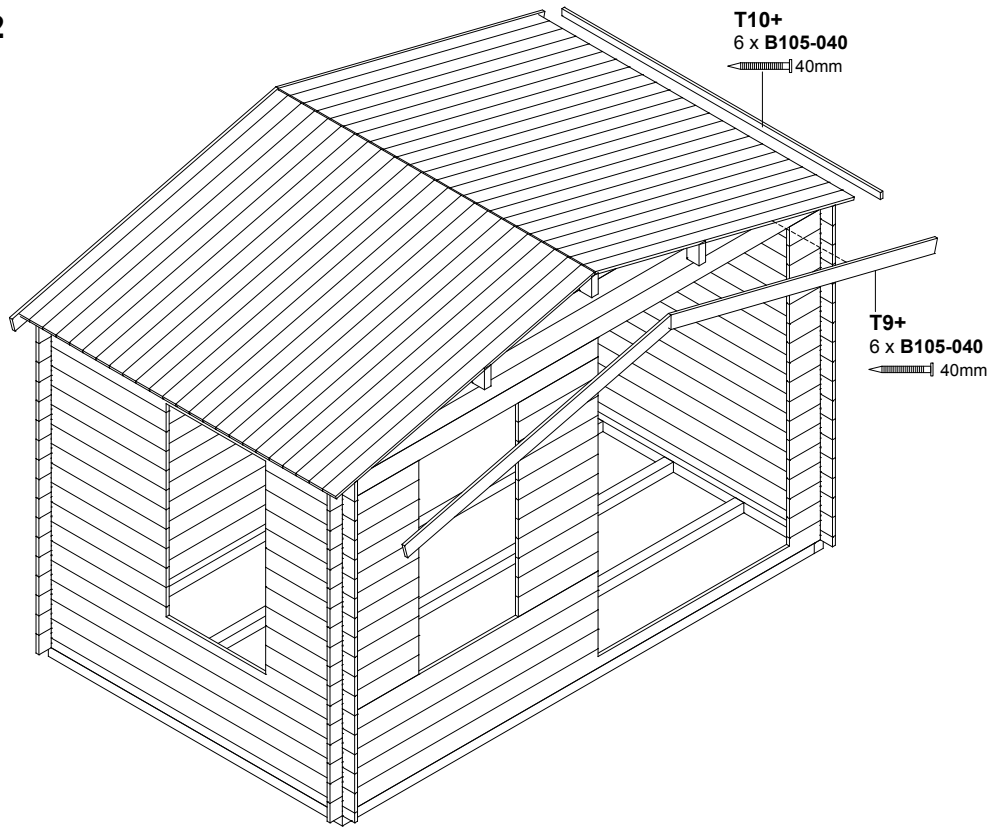
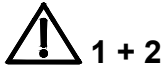

8

8

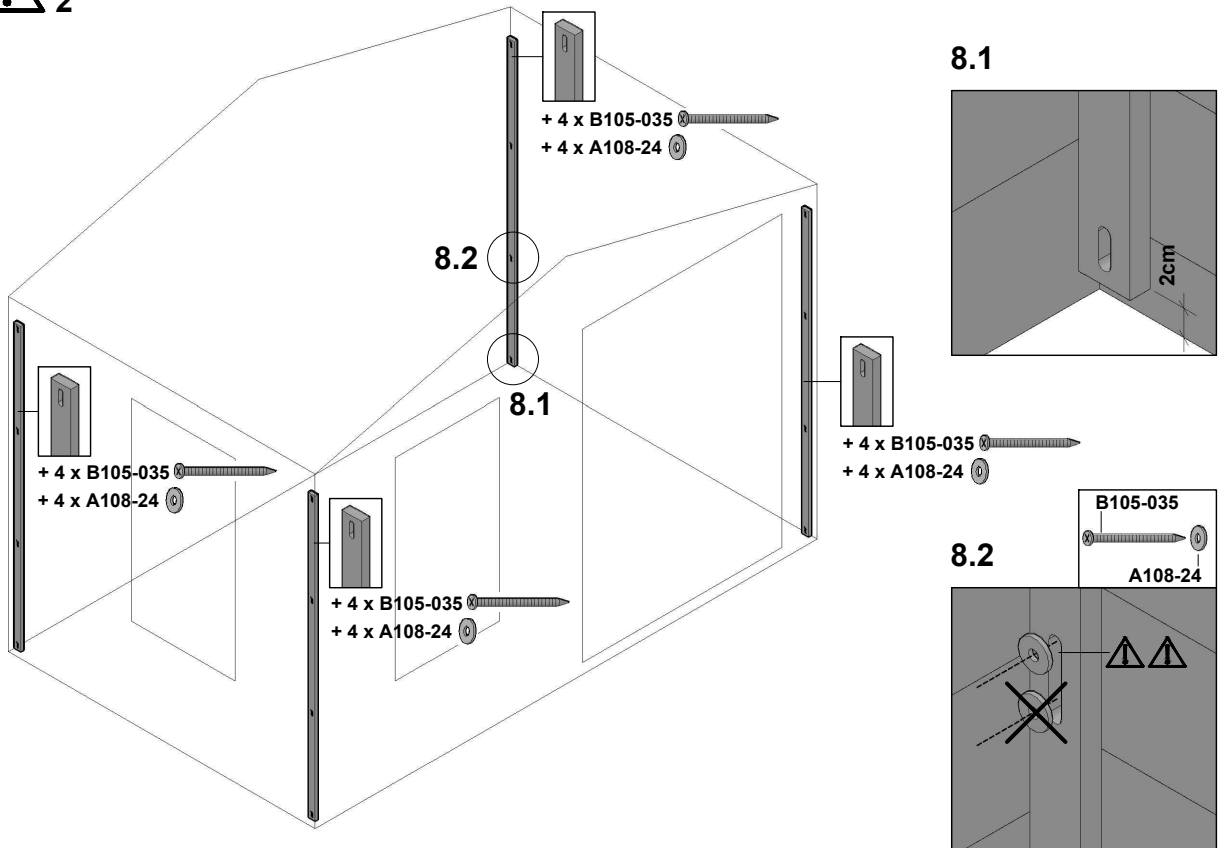



9

9

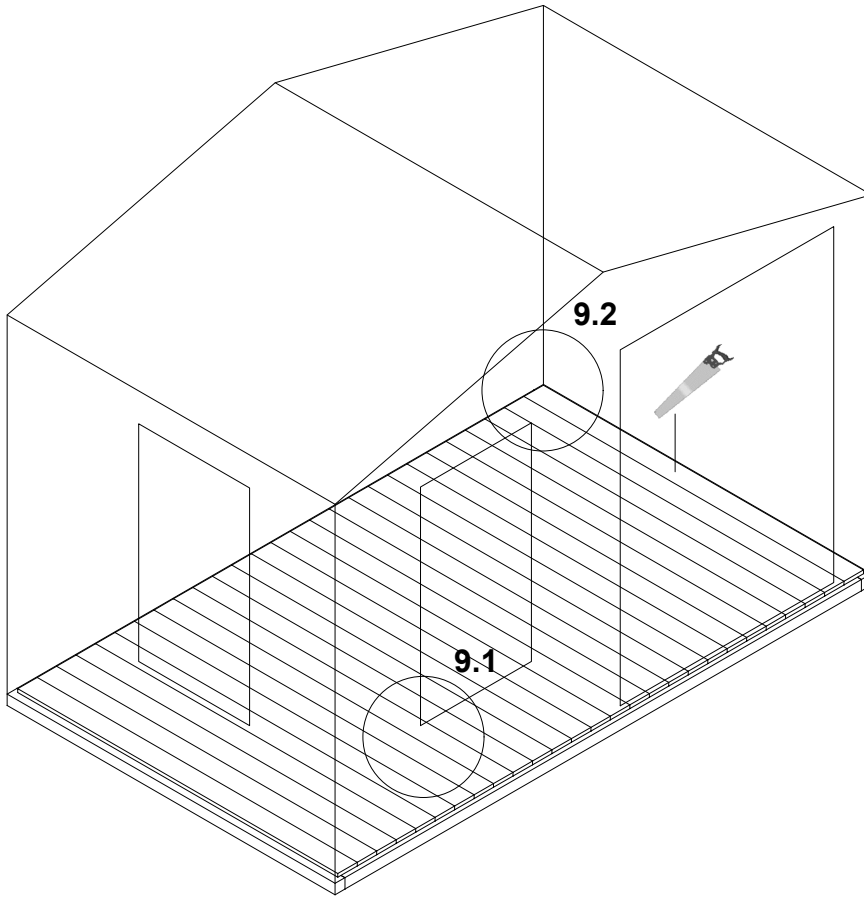



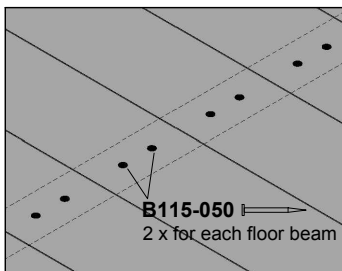



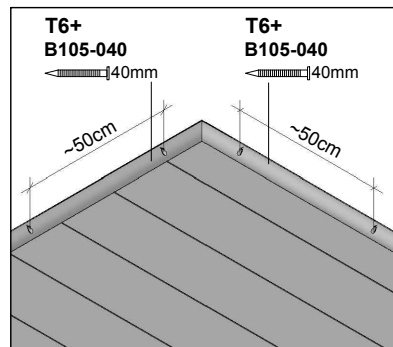

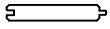
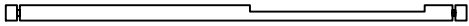
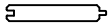

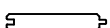
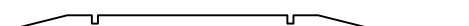
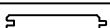

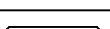
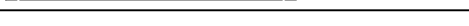
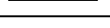
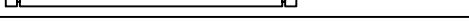
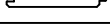
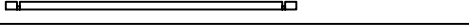
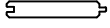
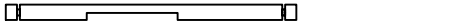
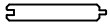
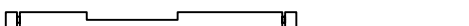
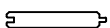

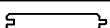
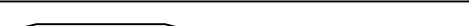
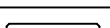

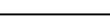
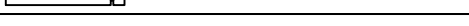
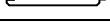
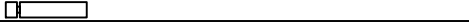
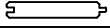

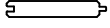

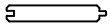

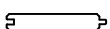

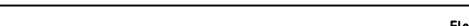

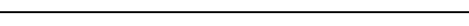
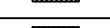

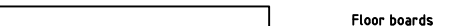

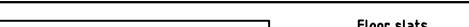

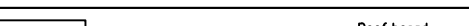

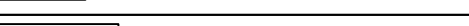
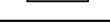

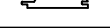
9.1

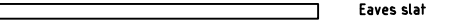

9.2



Pos	Garden Studio 330x210cm			Qnt	Dimens. (mm)	Length (mm)	Packed
001				2	19x110	3300	
002				1	19x110	3300	
003				17	19x110	3300	
004				2	19x110	2676	
005				2	19x110	2080	
006				20	19x110	2080	
007				2	19x55	2080	
008				1	19x110	2080	
009				1	19x110	2080	
010				5	19x110	1750	
011				2	19x110	1359	
012				10	19x110	850	
013				21	19x110	580	
014				11	19x110	520	
015				4	19x110	438	
016				16	19x110	300	
017				4	19x44	176	
T1	 Floor beams			5	40x58	3024	
T2	 Floor beams			2	40x58	1920	
T3	 Roof beams, sides			1+1	43x120	2080	
T4	 Roof beam, top			1	43x120	2080	
	WINDOW 640x1165			2			
	DOUBLE DOOR 1242x1750+door sill 20x37x1176mm			1			
T5	 Floor boards			36	14x95	1875	
T6	 Floor slats			6	20x20	2000	
T7	 Roof board			48	14x95	725	
T8	 Roof board			48	14x95	1025	
T9	 Gable slat			4	16x101	1800	
T10	 Eaves slat			2	16x40	2080	
T11	 Gable slat			2	19x120	265	
T12	 Gable slat			1	19x120	435	
T13	 Storm slat			4	19x38	1850	
	Fittings set			1			

Packed:

