

Important information

Please check the construction set for completeness using the position list in good time before starting construction or commissioning your construction team. If individual parts are defective or missing, we will deliver these as quickly as possible. However, we cannot refund the costs for any resulting construction delays to a construction company.

Please understand that we cannot assume any guarantee for the following defects:

- incorrect storage before assembly
- incorrect anchoring with the ground or inadequate foundation (foundation according to statics)
- damage due to erection errors, e. g. the house is not level or not right-angled
- damage through a higher level of snow burden than statically envisaged. Recommendation: load relief of the roof by removing the snow layer
- storm damage (insurance cases) or violent destruction
- damage through any alteration to the design by the client
- natural formation of cracks, branch holes, twisting, decolouration or similar modification (natural process; has no influence on the statics)

Storage information until construction:

- store pallet on a level and dry surface.
- Protect from exposure to sunlight and the influences of weather; wood can warp drastically in a loose condition!





Maintenance tips:



The wood is untreated. Accordingly, regular, protective coating is absolutely necessary! Please observe the attached information sheet "Care instructions/Colour treatment".

General tips and refers to:









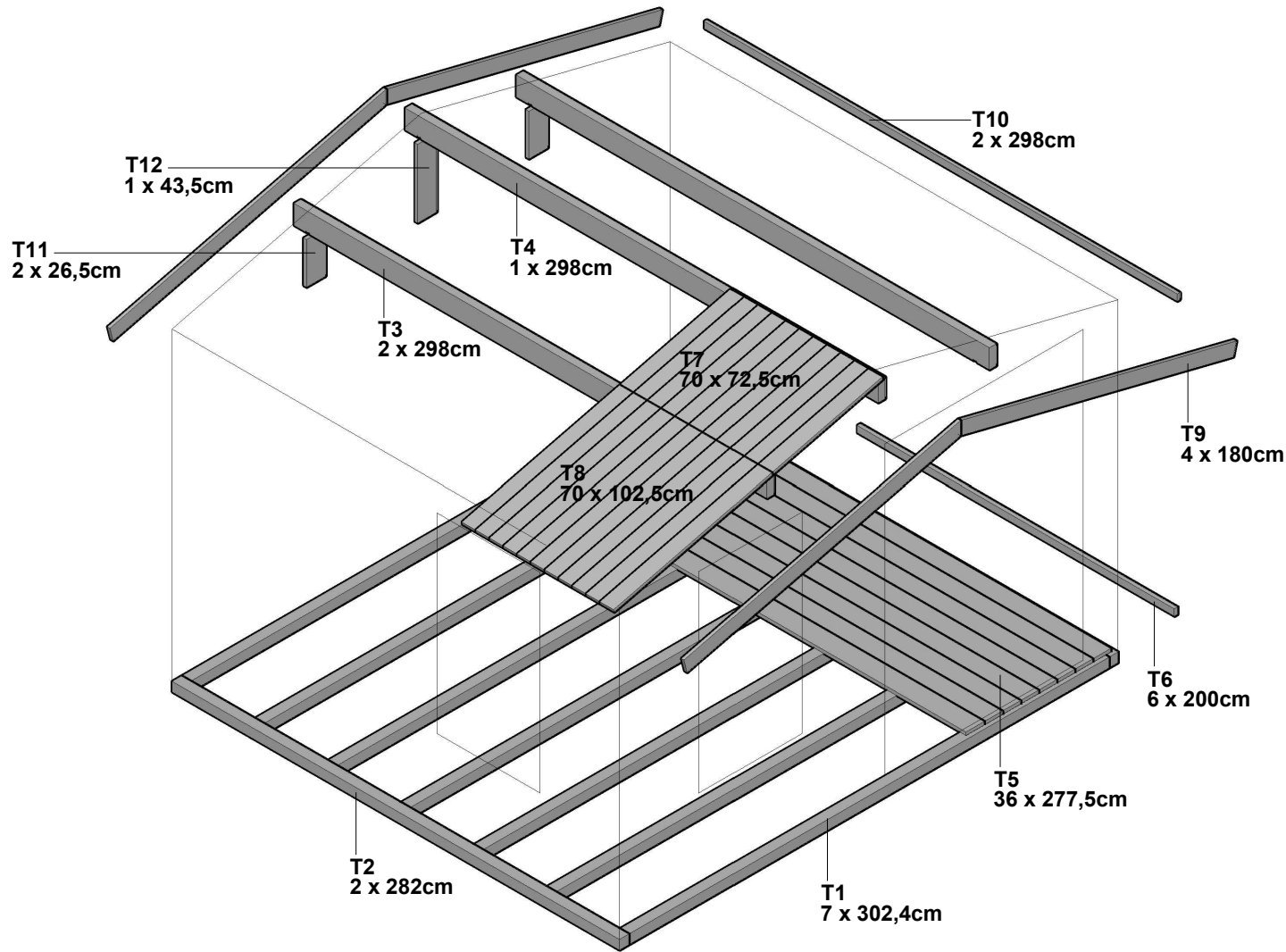



-  1 - The packaging foil **can be used** to keep moisture out of the house. It is laid according to the ground area of the house under the main bearing (not in delivery).
-  1 - **Foundation according to the structural calculations** (not included in the scope of delivery): concrete C25/30, each 2 Ø 12 top and bottom, brace mat R188A (alternatively brace Ø 6/20cm). Anchoring of the floor beams **(in the building)** on the strip foundation using bolts M12, e ≤ 60cm. The base bearings in the storeroom of the house must be entirely flush.
-  2 - **It is necessary to lay a tarpaper or equal on the roofboards.**
-  3 - Please note, that the screw with the washer has to **fasten on the top of the longholes in the strip for connecting the planks together**. It is important, that the screws **can move a little bit** and the roof doesn't come into contact with these connecting strips; **otherwise you have to cut these strips on the bottom. Please don't screw too tight.**



Garden Retreat 330 x 300cm



- 10 x B100 
- 520 x B115-050  50mm
- 40 x B105-020  20mm
- 28 x B105-030  30mm

- 16 x A108-24 
- 40 x B105-035  35mm
- 480 x B105-040  40mm
- 36 x B105-050  50mm
- 4 x B105-060  60mm
- 12 x B105-080  80mm
- 10 x B105-100  100mm

- 4 x T13 

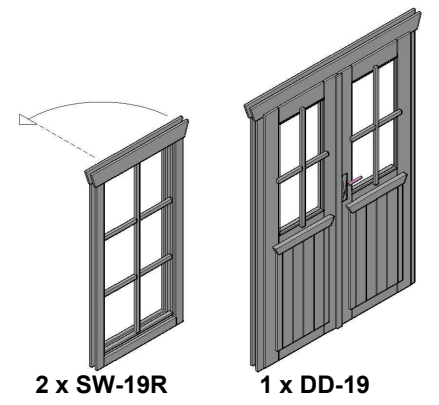



Garden Retreat 330 x 300cm

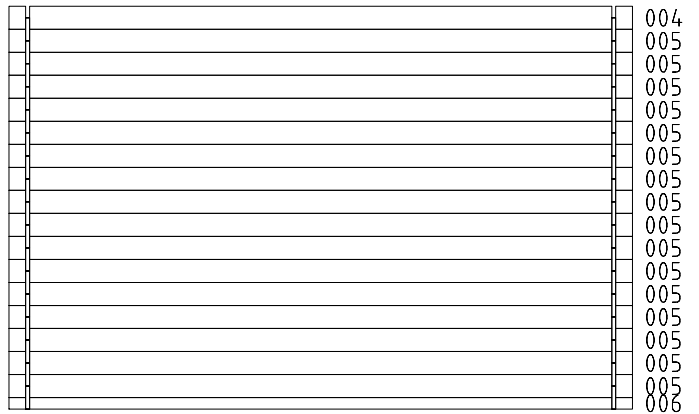
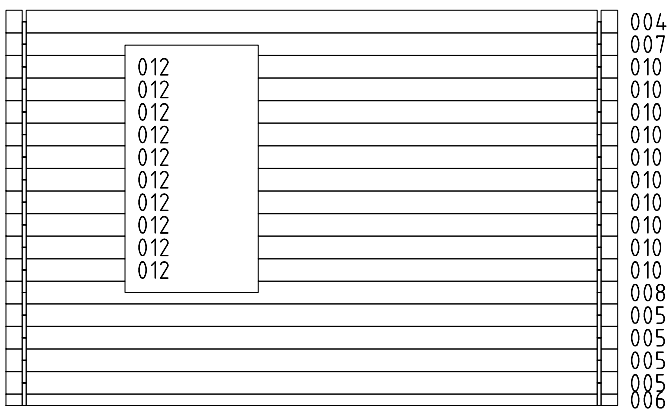
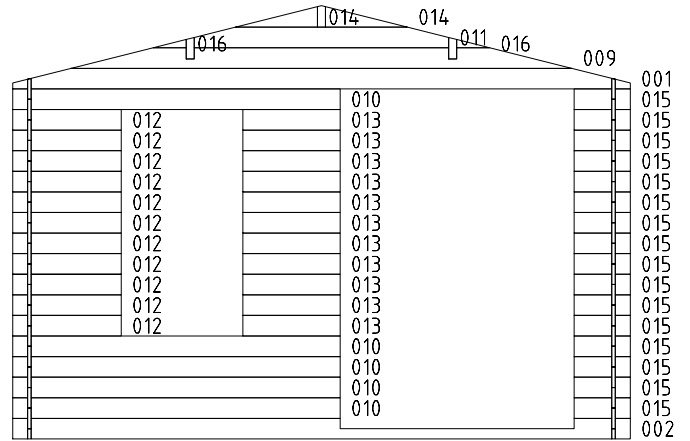
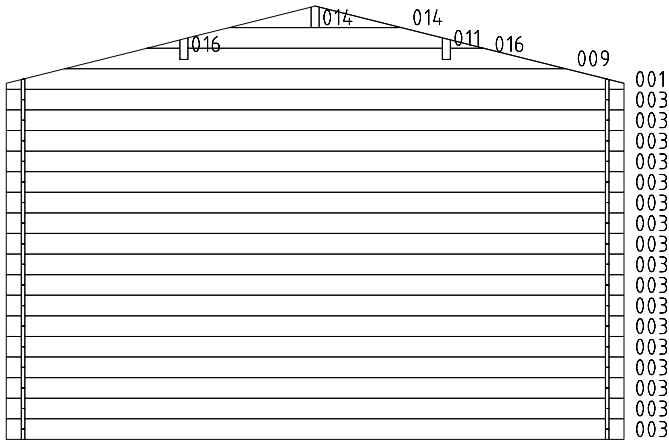

Zusätzlich / adicional:

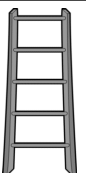
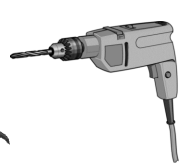
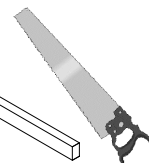
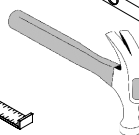
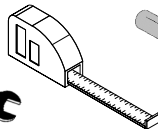
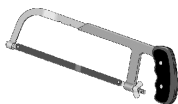



Garden Retreat 330 x 300cm



4

1

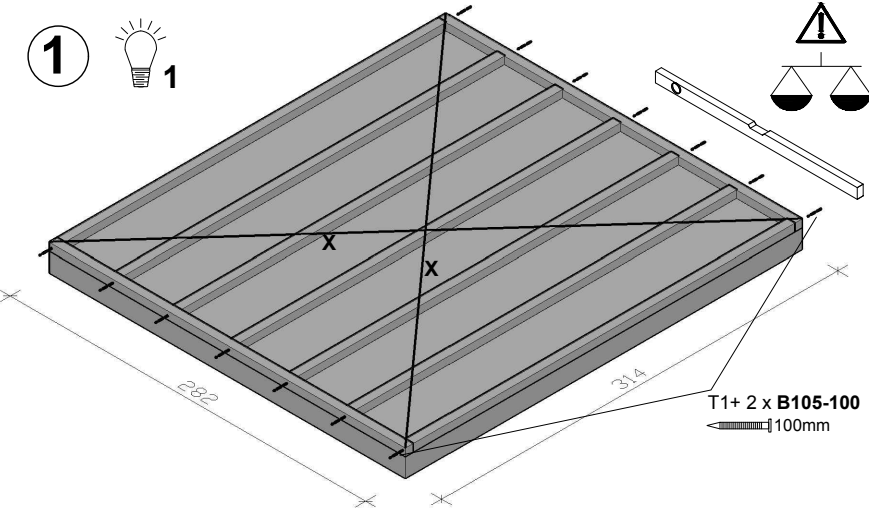

!!! X=X

1.1

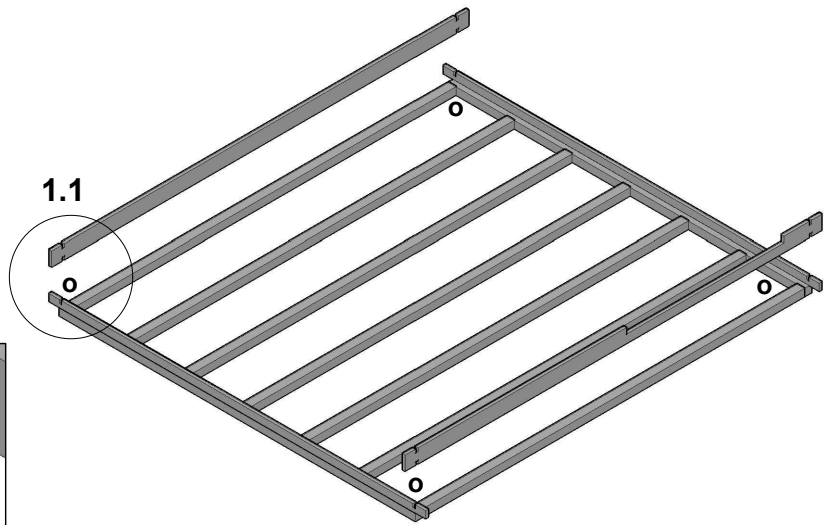
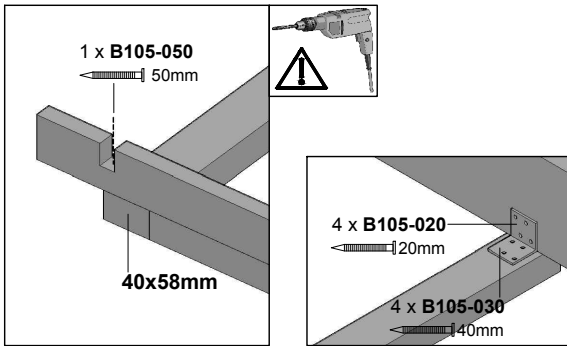

2

2.1

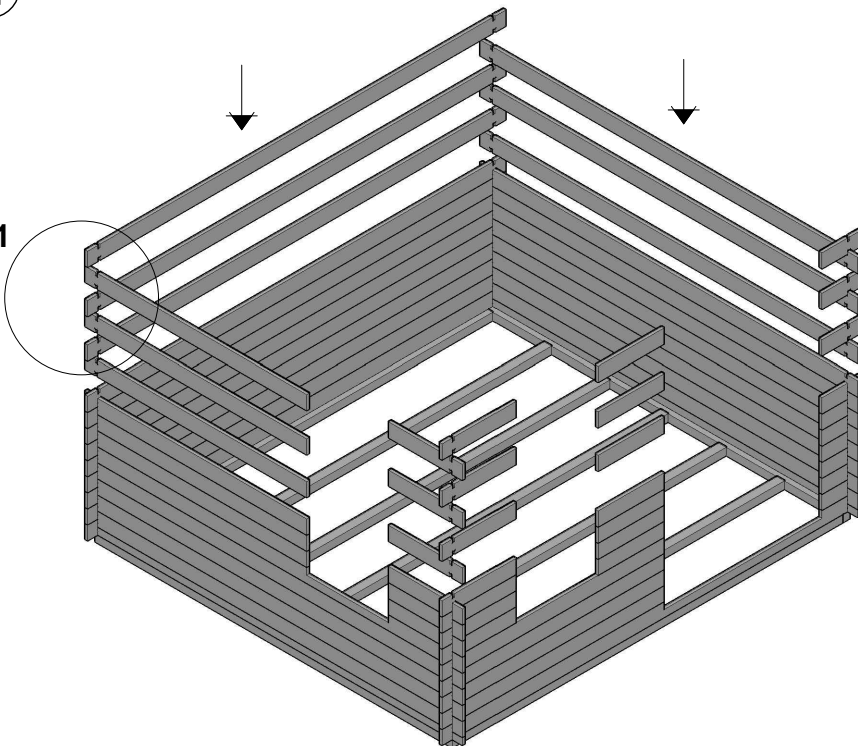

2.1

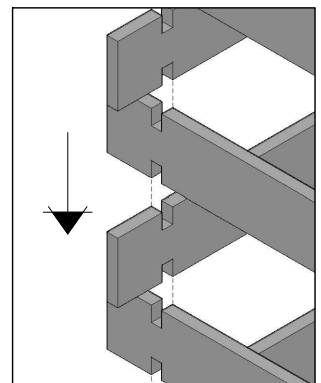



Garden Retreat 330 x 300cm



3

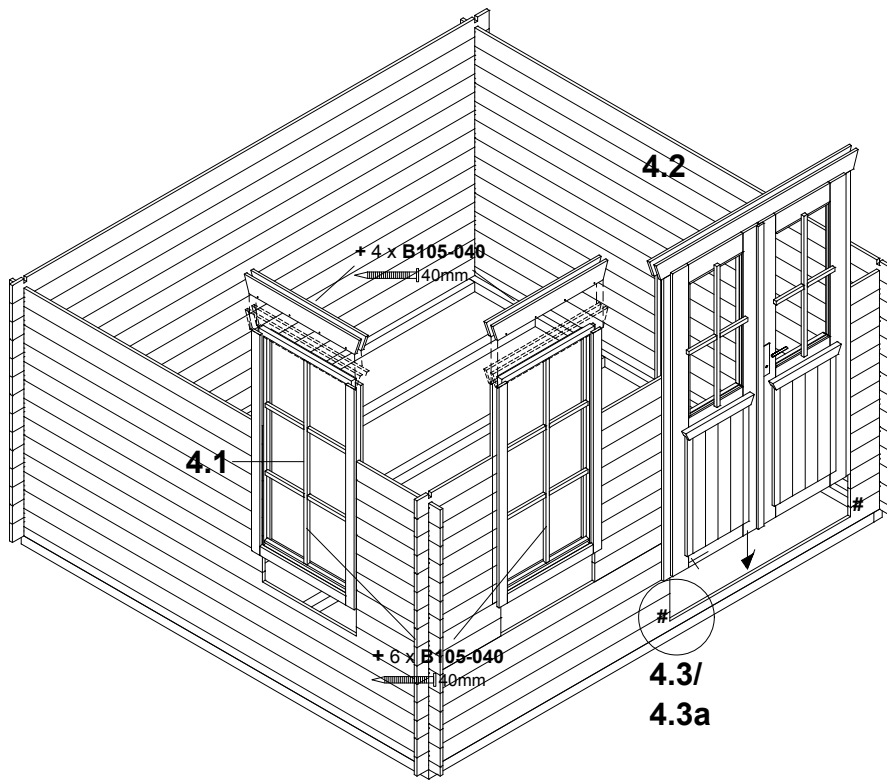

5

4.1

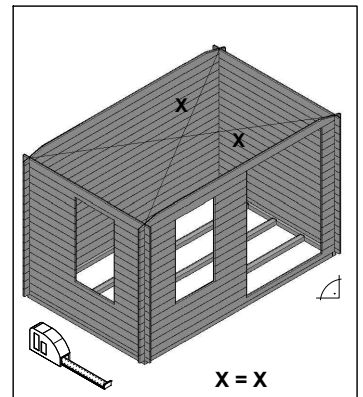
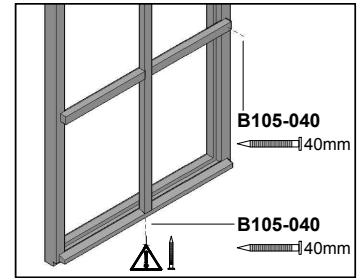

4

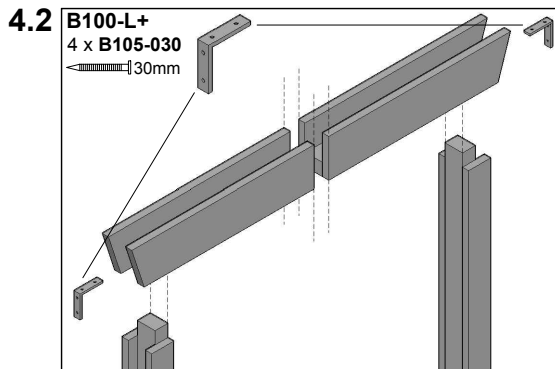

- Hang the doorleaf on the hinges **after** pushing the frame into position

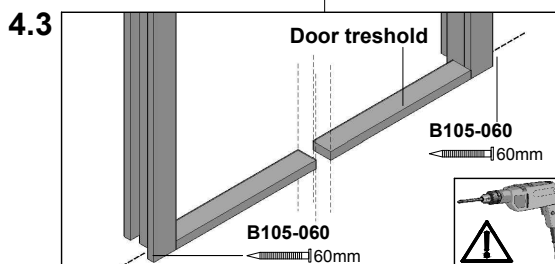

4.3a #

- inside

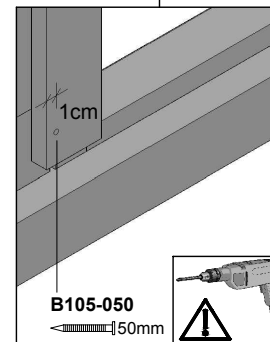



Garden Retreat 330 x 300cm



5

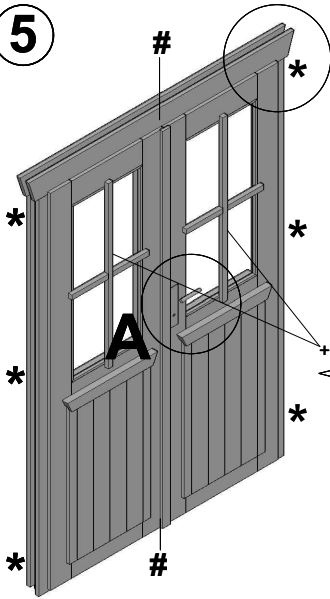

B

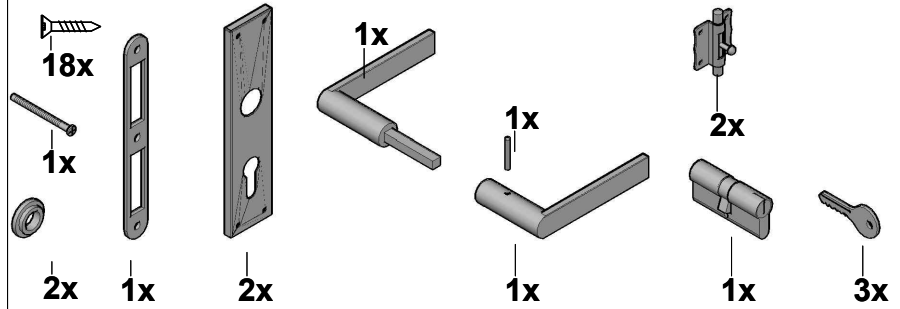

6

A

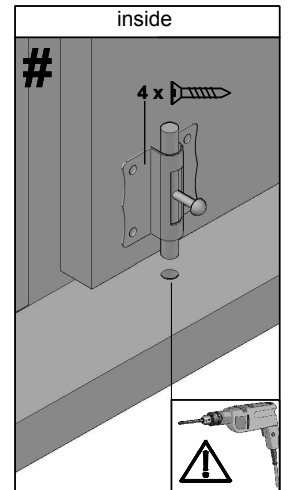
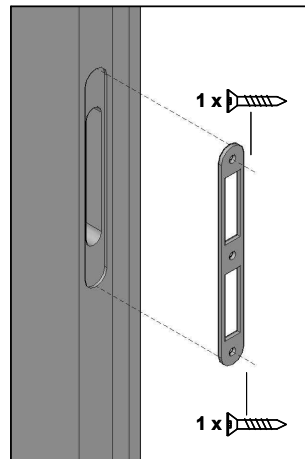
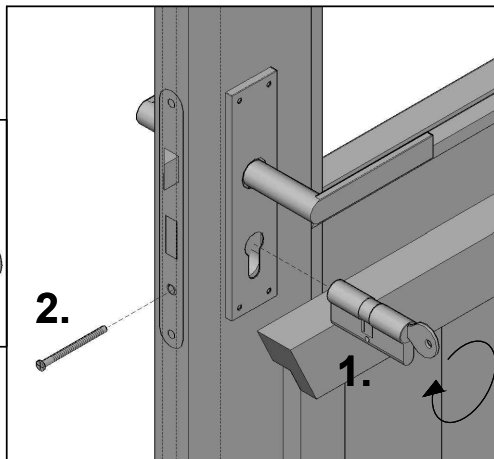
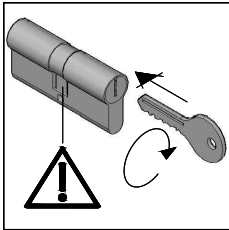
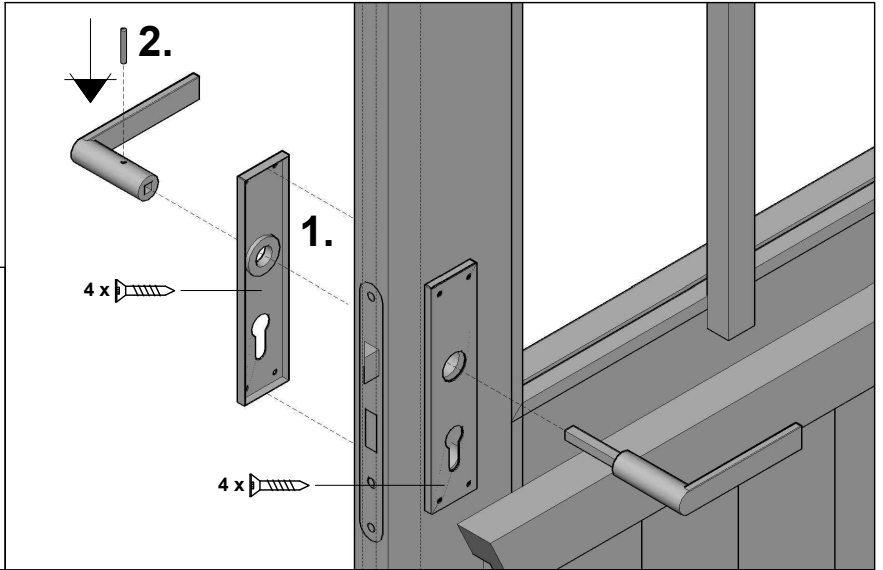
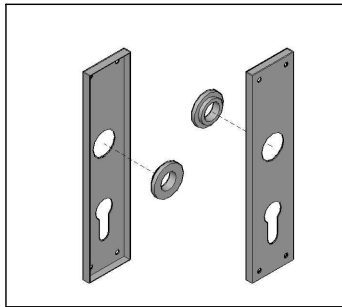

B

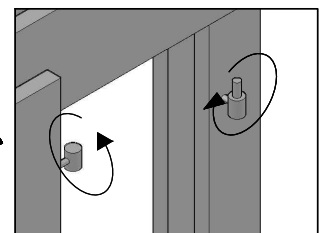
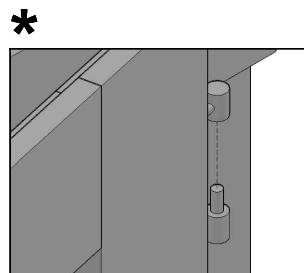



Garden Retreat 330 x 300cm



7

5

5.1

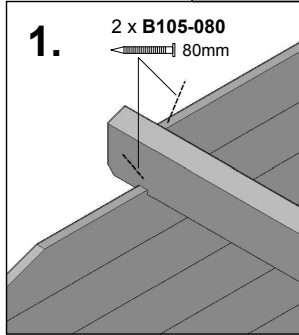

5.1

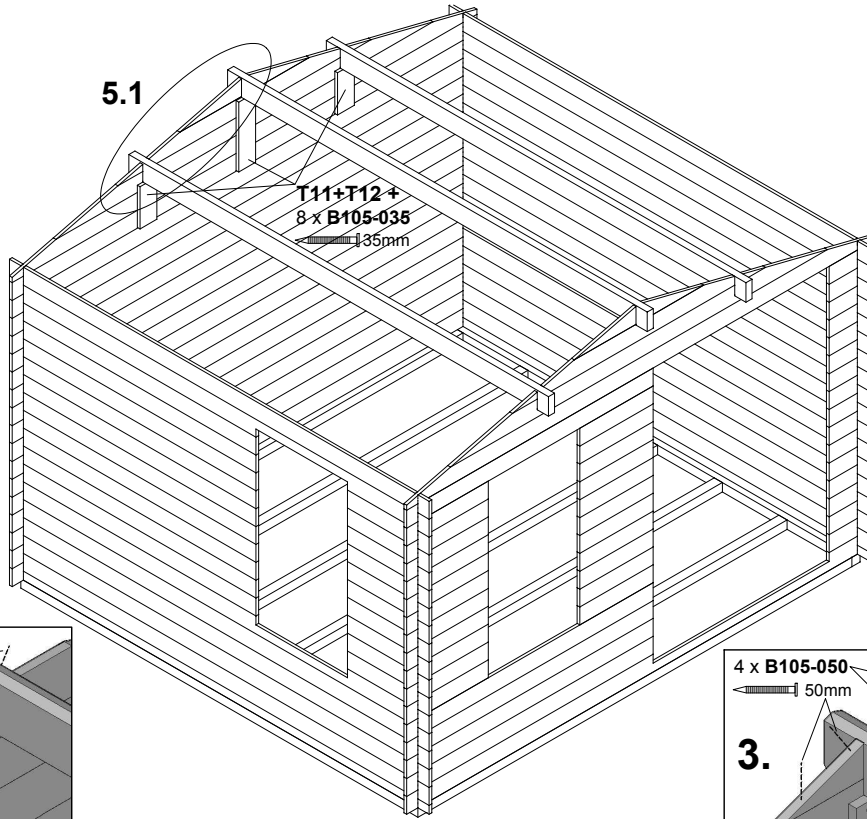

5.1

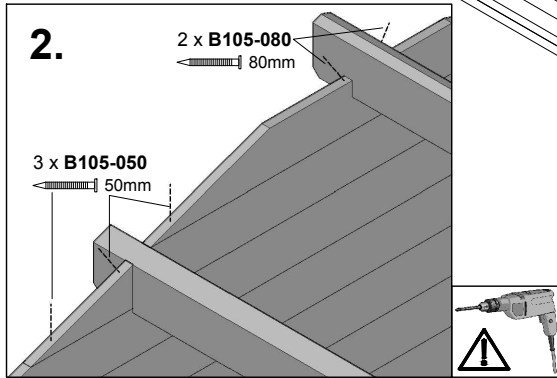

5.1

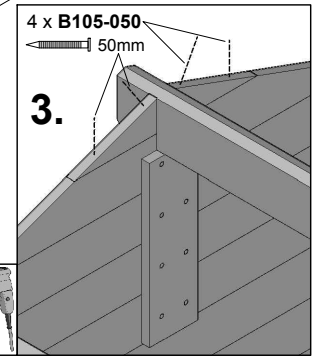

6

6.1

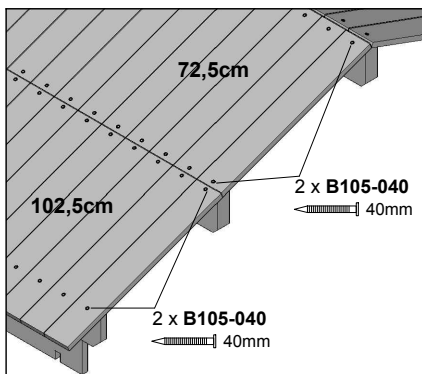

6.1

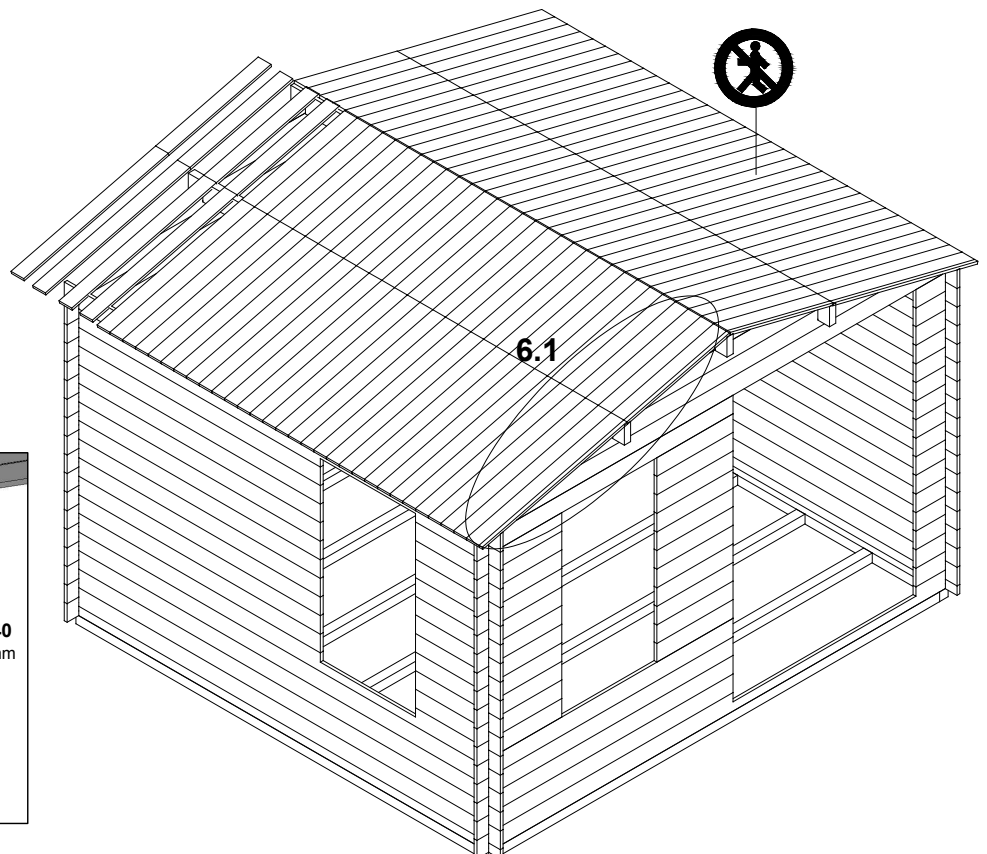



Garden Retreat 330 x 300cm



7

⚠ 1+2

8

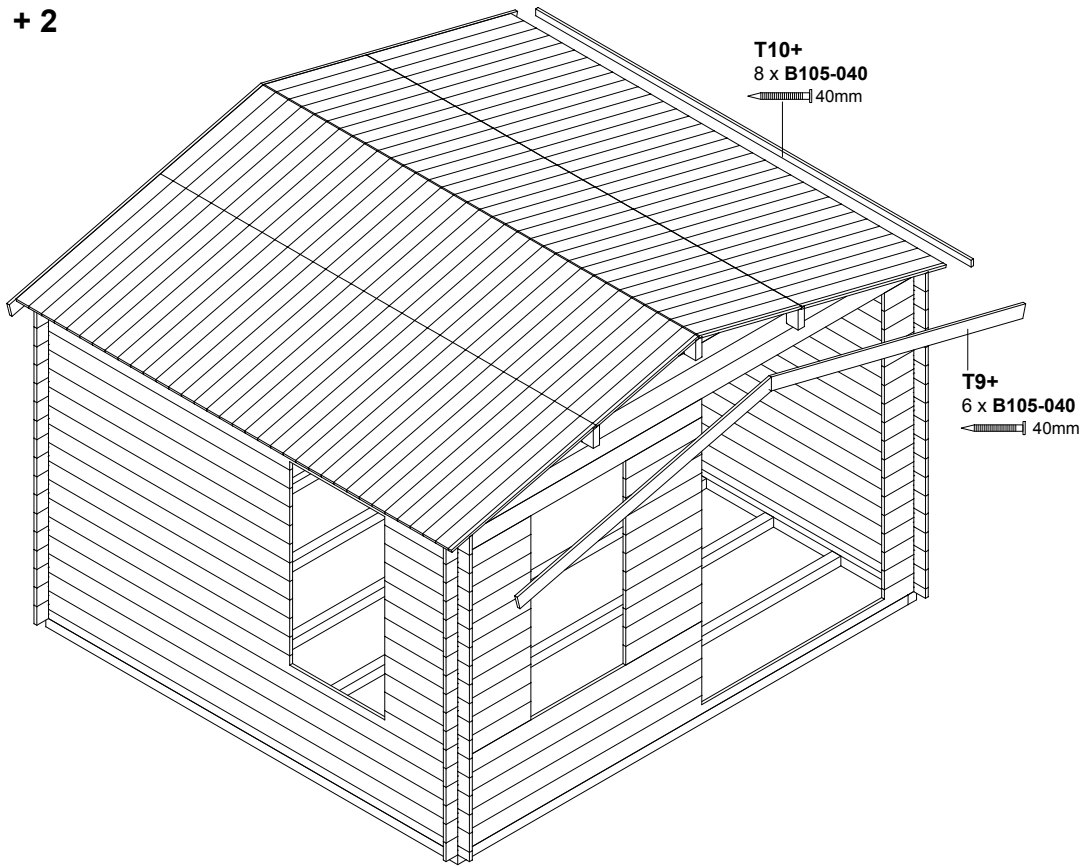

8

⚠ 2

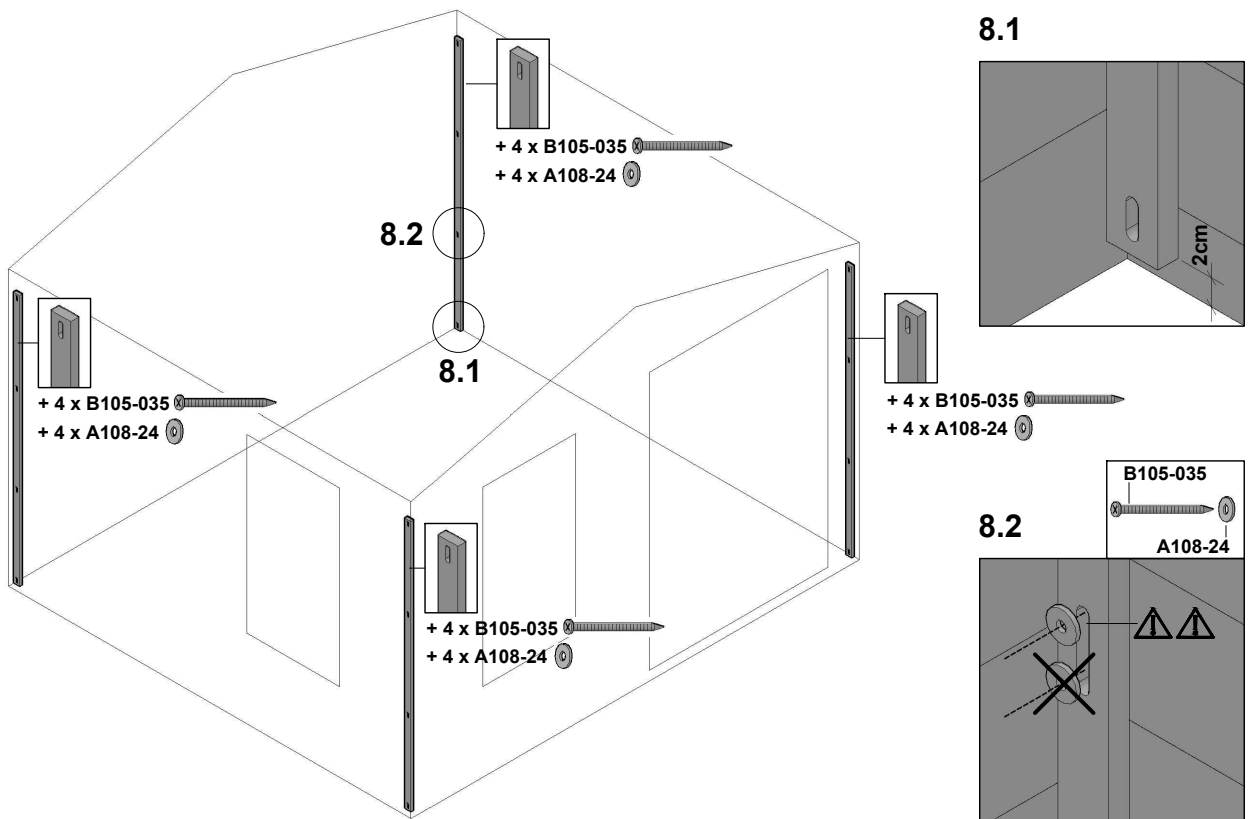



Garden Retreat 330 x 300cm



9

9

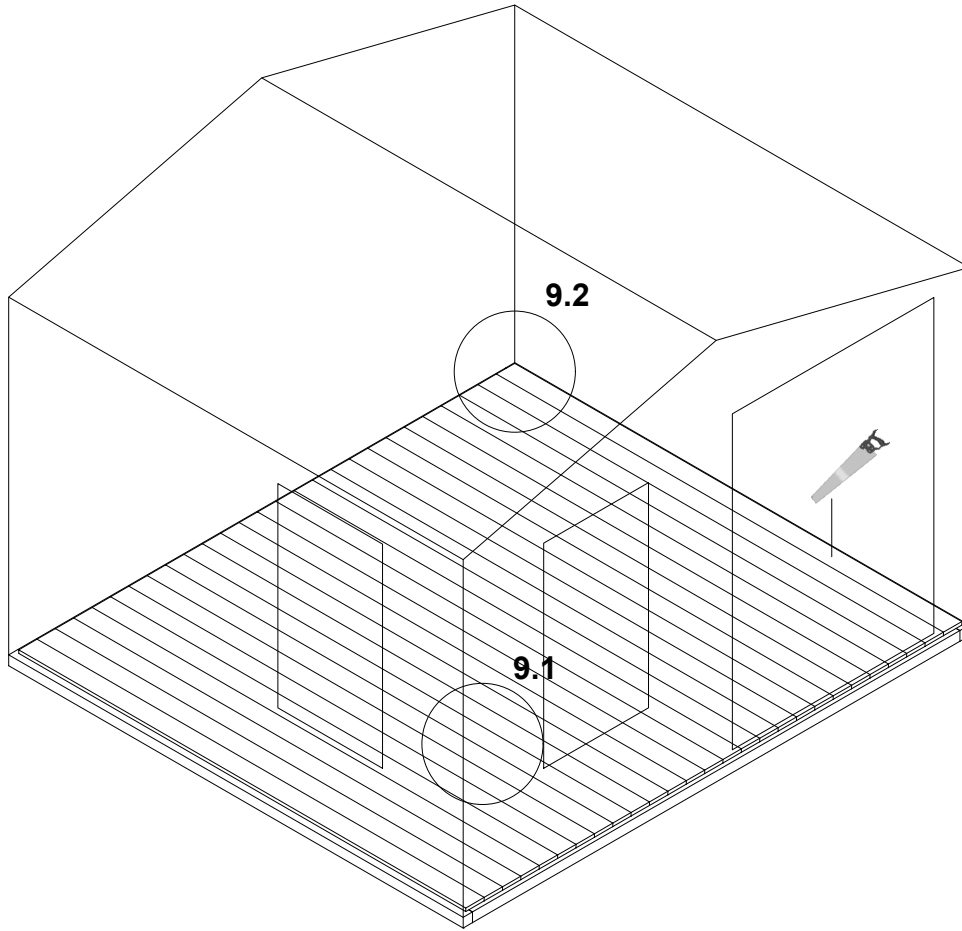



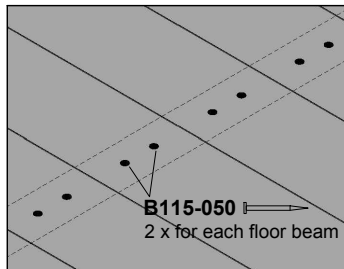



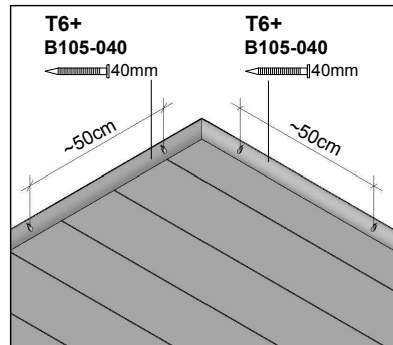

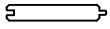
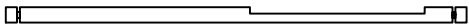
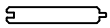
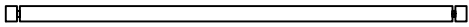
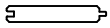
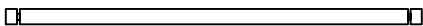
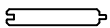
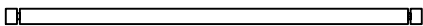
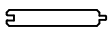
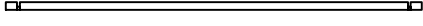
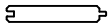
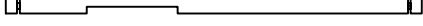
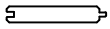
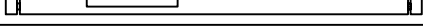
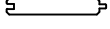
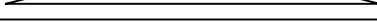
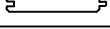
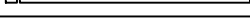
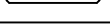
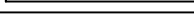
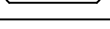

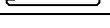

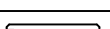

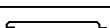

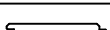

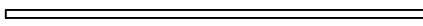

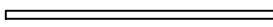

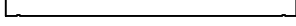

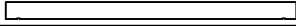



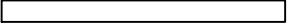

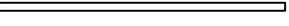

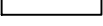

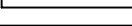
9.1

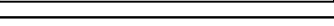

9.2

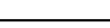

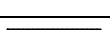
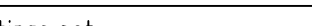
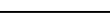
Pos	Garden Retreat 330x300cm			Qnt	Dimens. (mm)	Length (mm)	Packed
001				2	19x110	3300	
002				1	19x110	3300	
003				17	19x110	3300	
004				2	19x110	2980	
005				20	19x110	2980	
006				2	19x55	2980	
007				1	19x110	2980	
008				1	19x110	2980	
009				2	19x110	2676	
010				15	19x110	1750	
011				2	19x110	1359	
012				21	19x110	580	
013				11	19x110	520	
014				4	19x110	438	
015				16	19x110	300	
016				4	19x44	176	
T1	 Floor beams			7	40x58	3024	
T2	 Floor beams			2	40x58	2820	
T3	 Roof beams, sides			1+1	43x120	2980	
T4	 Roof beam, top			1	43x120	2980	
	WINDOW 640x1165			2			
	DOUBLE DOOR 1242x1750+door sill 20x37x1176mm			1			
T5	 Floor boards			36	14x95	2775	
T6	 Floor slats			6	20x20	2000	
T7	 Roof board			70	14x95	725	
T8	 Roof board			70	14x95	1025	
T9	 Gable slat			4	16x101	1800	
T10	 Eaves slat			2	16x40	2980	
T11	 Gable slat			2	19x120	265	
T12	 Gable slat			1	19x120	435	
T13	 Storm slat			4	19x38	1850	
	Fittings set			1			
Packed:							