

FLAT ROMAN OGEE

Flat roman ogees, for raised panelling or edge moulding. Used for decorative capping on hand rails.

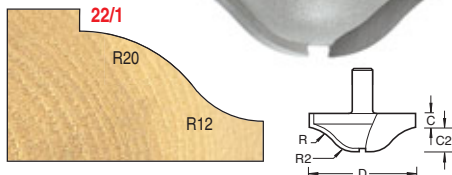

18,000
Ref. 22/1



R mm	R2 mm	D mm	C mm	C2 mm	Product Ref.	Shank Dia. 1/2"
19.0	11.0	41.5	8.0	8.0	22/08	£84.84
20.0	12.0	50.0	6.5	11.5	22/1	£84.84

FLAT OVOLO

Creates a wider panel mould for drawer fronts. Can be used to rout both tenons and housings.

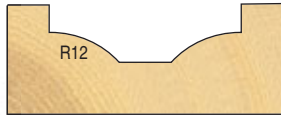

R mm	D mm	C mm	Product Ref.	Shank Dia. 1/4"
12.0	25.0	8.0	7/06	£47.27

OVOLO

Ideal for edge of drawer fronts and cabinet doors.

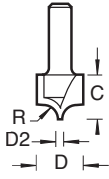

R mm	D mm	D2 mm	C mm	Product Ref.	Shank Dia. 1/4"
4.0	13.0	1.2	12.0	11/50	£31.78

OVOLO

Panel mould and edge mould cutter.

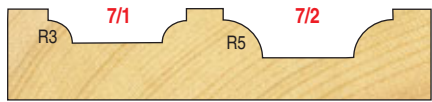

R mm	D mm	D2 mm	C mm	Product Ref.	Shank Diameter 1/4"	Shank Diameter 1/2"
2.5	9.5	3.2	9.0	7/01	£27.79	-
3.0	18.0	12.0	10.0	7/1	£39.70	-
5.0	22.0	12.0	12.0	7/2	£53.60	£53.59

PANEL & VEINING

A range of small sized panelling cutters. Ideal for veining and fluting applications.

Ref. 16/2

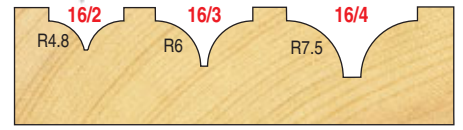

R mm	D mm	C mm	Product Ref.	Shank Dia. 1/4"
4.8	9.5	7.5	16/2	£42.38
6.0	13.0	12.5	16/3	£45.57
7.5	14.5	19.5	16/4	£48.75

SHANK MOUNTED BEARING GUIDED CHAMFER

Template thickness should be 5mm thicker than cut length of cutter.



Ref. 11/20



A Deg.	D mm	C mm	B mm	Product Ref.	Shank Diameter 1/4"	Shank Diameter 1/2"
60°	12.7	16.0	12.7	11/20	£40.37	-
45°	12.7	12.7	12.7	11/40	£35.46	-
45°	19.1	16.0	19.1	11/41	-	£37.83

SHANK MOUNTED BEARING GUIDED HOUSING

Template thickness should be 5mm thicker than cut length of cutter. Can be used to rout both tenons and housings.

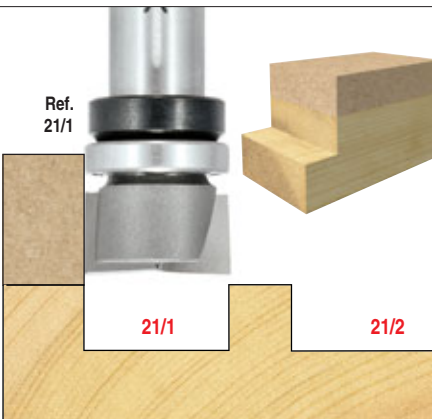
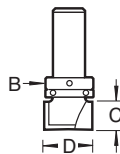

Ref. 21/1

D mm	C mm	B mm	Product Ref.	Shank Diameter 1/4"	Shank Diameter 1/2"
19.1	11.1	19.1	21/1	£46.58	£46.58
25.4	11.1	25.4	21/2	-	£48.71
38.1	16.0	38.1	21/3	-	£68.16

SHANK MOUNTED BEARING GUIDED RADIUS

Template thickness should be 5mm thicker than cut length of cutter.



Draining board

R mm	D mm	C mm	B mm	Product Ref.	Shank Diameter 1/4"	Shank Diameter 1/2"
6.35	12.7	9.5	12.7	13/40	£35.46	-
7.9	15.9	11.0	16.0	13/41	£47.94	-
9.5	19.0	11.0	19.0	13/42	£57.67	-
9.5	19.0	32.0	19.0	13/50	-	£66.03

+ While stocks last

! For stationary machines at max. recommended speeds as indicated.