

How to make a
FRAME
& **PANEL**
Cabinet Door

A guide to using profile scribing and raised panel cutters



Profile scribing and raised moulding cutters can be used to produce traditional panelled frame doors to a professional standard.

This booklet is intended for both amateur and professional woodworkers and aims to outline the techniques involved and the basic equipment required. With 1/4" shank profile scribing and raised panel moulding cutters, low powered routers (above 750 watts) can be used for this purpose. This allows anyone with basic woodworking skills, tools and equipment to produce high quality, decorative and attractive cabinets and fitted furniture.



CONTENTS

1	FRAME & PANEL DOOR CONSTRUCTION _____	2-9
	Door Styles _____	4 - 5
	Component Dimensions _____	6 - 7
	Meeting Stiles _____	8 - 9
2	PROFILE SCRIBING CUTTERS _____	10-17
	Profile Scribing Cutter Assembly _____	12 - 13
	Profile Scribing Cutter Sets _____	14 - 15
	Profile Scriber Multi Set _____	16
	Panel Door Sets _____	17
3	MATERIALS & OTHER EQUIPMENT _____	18-21
	Other Equipment _____	20 - 21
4	THE FRAME _____	22-33
	The Scribe _____	23 - 27
	The Edge Profile _____	28 - 30
	Shaped Rails _____	31 - 33
5	THE PANELS _____	34-41
	Panel Styles _____	35
	Jointing _____	36 - 37
	Assembly _____	38 - 39
	Calculating the Panel Size _____	40 - 41
6	PANEL CUTTERS _____	42-49
	Vertical _____	43
	Bearing Guided and Horizontal _____	44 - 45
	Radiused and Ogee _____	46 - 47
	Ovolo, Classic and Bevel _____	48 - 49
7	USING RAISED PANEL CUTTERS _____	50-57
	Setting Up _____	51
	Making a Template _____	52 - 53
	Combined Jig and Scoring _____	54 - 55
	Lead-On Piece _____	56
	Summary of Safety Techniques _____	57
8	DOOR ASSEMBLY _____	58-62
	Hinges _____	60 - 61
	Edge Moulding _____	62

1 FRAME & PANEL DOOR CONSTRUCTION

Panelled door frames are made up of two vertical stiles and two horizontal rails. The inside edge of the stiles and rails are grooved to take the panel edge and the rail end tenon.

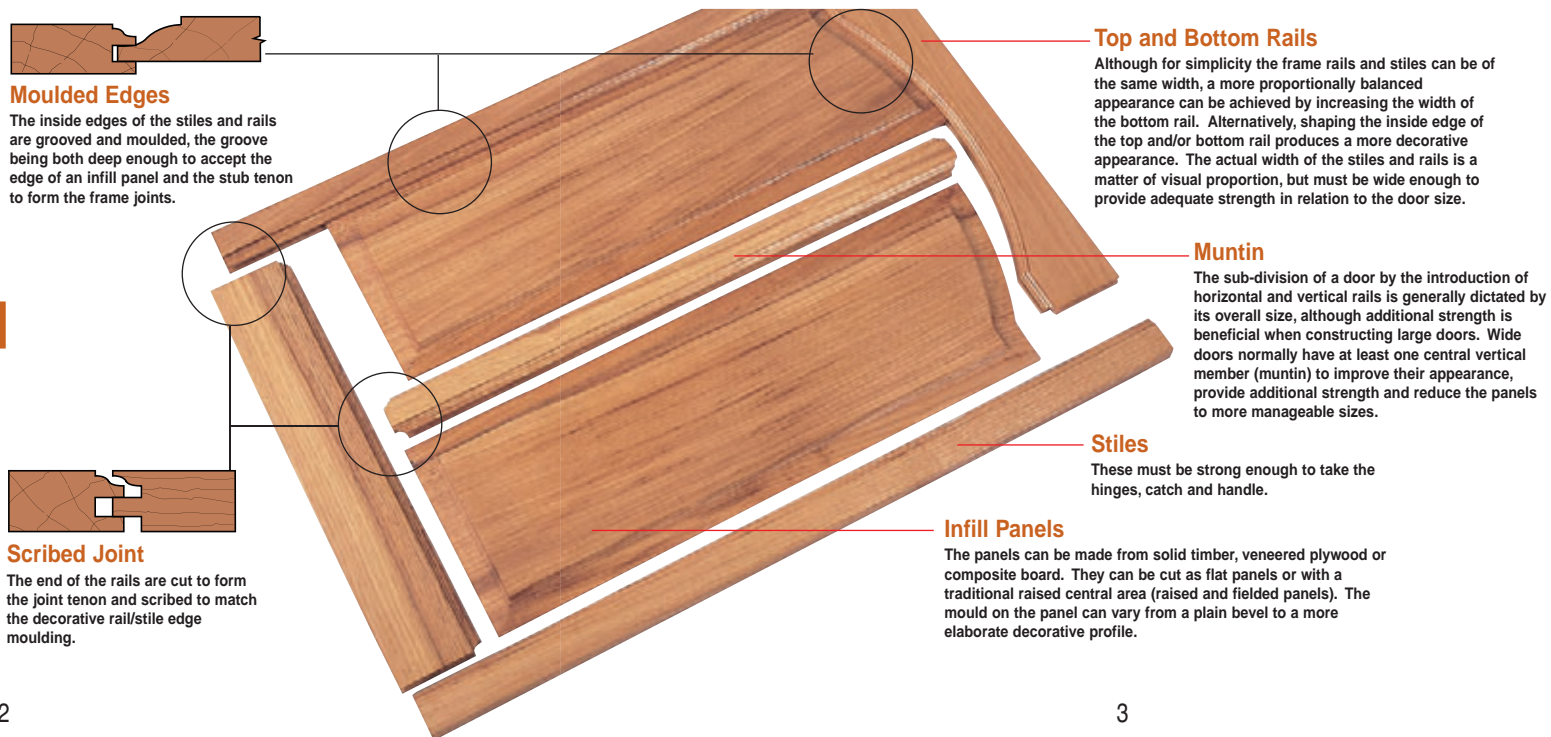

Moulded Edges

The inside edges of the stiles and rails are grooved and moulded, the groove being both deep enough to accept the edge of an infill panel and the stub tenon to form the frame joints.

Scribed Joint

The end of the rails are cut to form the joint tenon and scribed to match the decorative rail/stile edge moulding.

Top and Bottom Rails

Although for simplicity the frame rails and stiles can be of the same width, a more proportionally balanced appearance can be achieved by increasing the width of the bottom rail. Alternatively, shaping the inside edge of the top and/or bottom rail produces a more decorative appearance. The actual width of the stiles and rails is a matter of visual proportion, but must be wide enough to provide adequate strength in relation to the door size.

Muntin

The sub-division of a door by the introduction of horizontal and vertical rails is generally dictated by its overall size, although additional strength is beneficial when constructing large doors. Wide doors normally have at least one central vertical member (muntin) to improve their appearance, provide additional strength and reduce the panels to more manageable sizes.

Stiles

These must be strong enough to take the hinges, catch and handle.

Infill Panels

The panels can be made from solid timber, veneered plywood or composite board. They can be cut as flat panels or with a traditional raised central area (raised and fielded panels). The mould on the panel can vary from a plain bevel to a more elaborate decorative profile.

DOOR STYLES



Rectangular Flat Panelled

Simple rectangular frames can be fitted with flat plywood or MDF panels, veneered to match the frame. Alternatively the frame and panel can be finished with a coloured stain or paint.



Raised and Fielded Panel with Muntin

For a more traditional style cabinet door, a raised and fielded panel can be fitted. These can be made using our range of panel raising cutters (see page 238).



Flat Ply Panel with Muntin

Rectangular frames can be further divided into smaller panels by adding vertical (muntin) and horizontal rails. This is particularly advantageous when making large doors that require more rigid construction.

4



Flat Four Panel

Multi-panelled doors can be produced, using the profile scribing cutter to cut the scribed rail end and the profile edge moulding on both edges of the middle rail and the two muntins.



Curved Top Rail

By using trammels or radius jigs, the inside edges of the top and bottom rails of the door can be cut as a regular curve. The same jig or a template can then be used to shape the matching panel.



Cambrio Top Rail

Cathedral top or cambrio shapes can be produced using a pre-cut template for both the rails and the matching panel edges. Shaped panel edges can be easily cut using ball bearing guided panel raising cutters.

5

COMPONENT DIMENSIONS

Frame Thickness

The thickness of the rails and stiles should be in relation to the overall door size and will therefore effect the choice of cutter. Frames for larger or heavier doors should be between 20-22mm, for smaller cabinet doors and fixed panels 18-20mm thickness. This can be further reduced to 16mm by using the smaller profile/scribing cutters. A maximum frame thickness of 26mm is possible using two of the larger profile/scribing cutters sets (Trend ref. PSC/20 and PSC/40 see page 237).

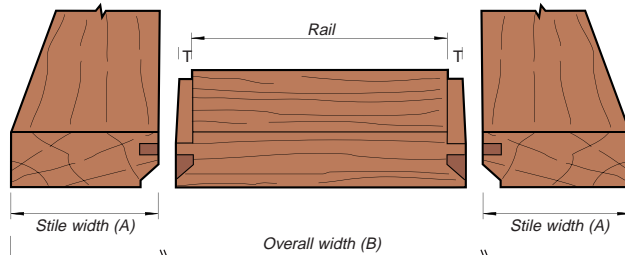

Rail Length

The length of the rail components must take into account the length of the stub tenon at each end. The length of the tenons can be either 9.5mm or 12mm (see chart to the right). The actual rail length is therefore:

**The overall width of the frame
less twice the stile width
plus twice the tenon length
or
Rail length = B - (2 x A) + (2 x T)**

Tenon Lengths (T)

9.5mm	12mm
PSC/1	PSC/2
PSC/10	PSC/20
PSC/3	PSC/4
PSC/30	PSC/40
PSC/5	
PSC/50	
C149	

For information on Panel Dimensions see page 237.

6

Profile Scriber Dimensions

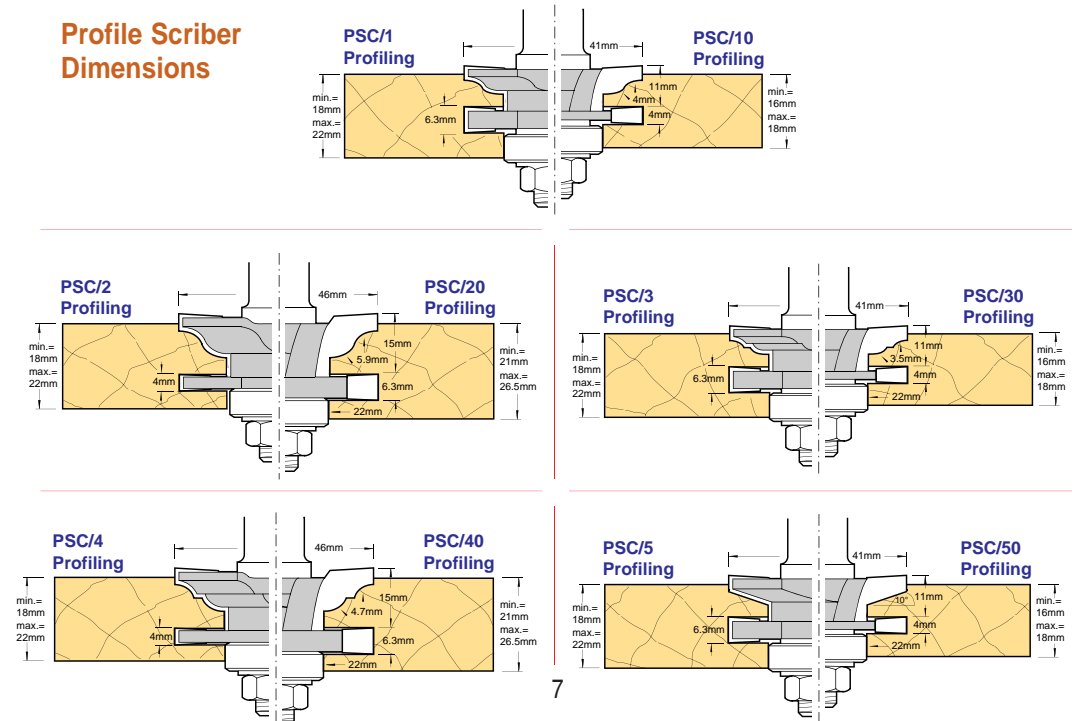

7

MEETING STILES

On cabinets with no centre partition or vertical frame to form a stop behind the meeting stiles of double doors, the meeting edges are generally rebated.

As the width across each face of the two meeting stiles would appear uneven, it is common practice to cut a false narrow line on the face of the stile. This should be equal to the gap between the meeting edges in order to visually balance them.

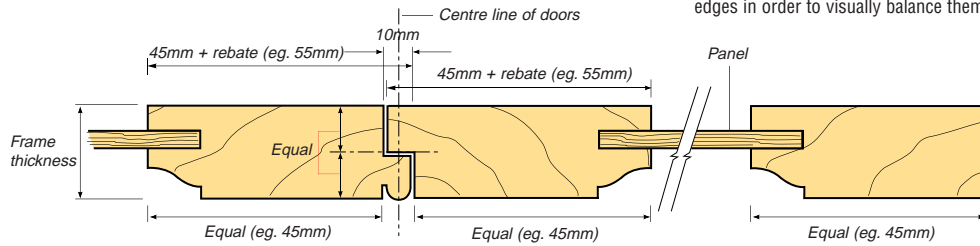

8

2 PROFILE SCRIBING CUTTERS

Mounted on an arbor, the components of the profile scribing cutter sets are arranged to cut the reverse scribe on the rail ends, before being rearranged to cut the matching profile and panel groove along the inside edges.

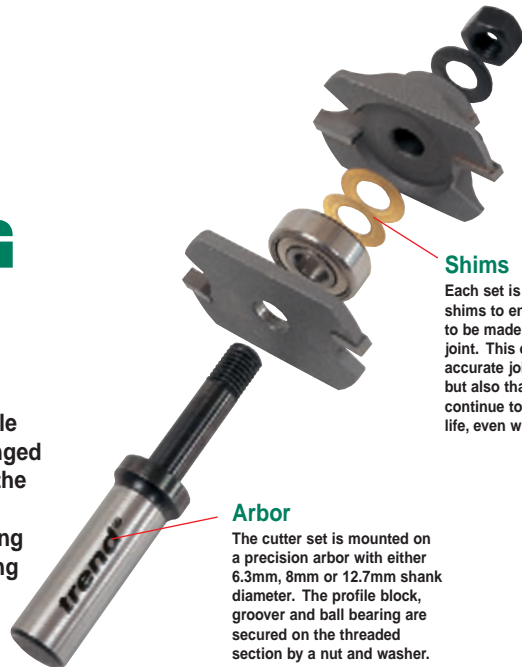

Arbor

The cutter set is mounted on a precision arbor with either 6.3mm, 8mm or 12.7mm shank diameter. The profile block, groover and ball bearing are secured on the threaded section by a nut and washer.

Shims

Each set is supplied with a set of shims to enable fine adjustments to be made to the tightness of the joint. This ensures that not only accurate joints can be produced, but also that the cutter set will continue to do so throughout its life, even with regular honing.

10

1 To allow for the rebate, both meeting stiles must be cut wider by the width of the rebate (6 to 10mm). The opposite faces of the two stiles are rebated using a straight cutter guided by the side fence, or a bearing guided rebate cutter.

2 Cut a bead moulding along the vertical edge of the front door with a corner bead cutter using a diameter equal to the width of the rebate.



Cutter Ref. 46/39 x 1/4TC



Cutter Ref. 9/71x1/4TC



Other sizes of corner beads are available

9

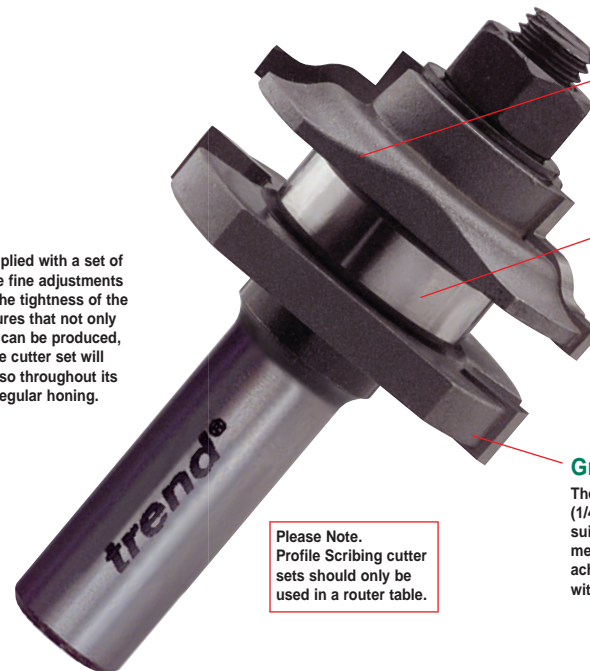

Profile Block

Profile scribing sets are available with a range of different profile blocks, ranging from a standard bevel to an elaborate classic style moulding.

Ball Bearing

The set is fitted with a precision guide bearing that guides the cutter along the rail edge to determine the depth of the panel groove and the width of the edge moulding. When set up to cut the scribe, it also determines the thickness of the stub tenon.

Groover

The standard panel groove is 6.3mm (1/4 inch) wide, although a 4mm groove, suitable for thin plywood, glass, brass mesh or fabric covered panels, can be achieved using our cutter sets supplied with a 4mm groover.

Please Note. Profile Scribing cutter sets should only be used in a router table.

11

Chip Limiters

All Trend profile scribing and panel raising cutters are produced with chip limiting characteristics to HOLZ BG standard. This reduces the risk of kick-back as the cutter enters the wood and restricts the amount of material that can be removed on each cutter revolution.

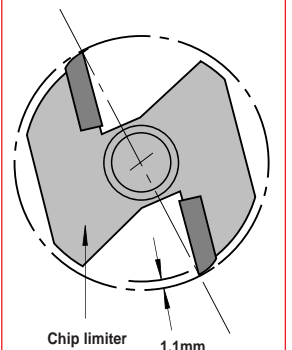

Chip limiter 1.1mm

PROFILE SCRIBING CUTTER ASSEMBLY

Cutter set-up for scribing

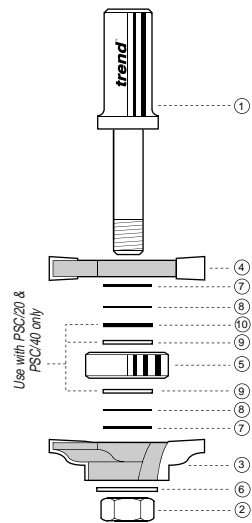

Parts supplied in profile scribing cutter set

1. Arbor with 1/4", 1/2" or 8mm shank
2. Nut (13mm A/F)
3. Profile Block
4. Groover
5. Ball Bearing 22mm diameter
6. Washer 1.0mm (x1)
7. Shims 0.1mm (x3)
8. Shims 0.05mm (x3)
9. Spacers 1.0mm (x2) (PSC/20, PSC/40 only)
10. Shim 0.5mm (x1) (PSC/20 & PSC/40 only)

The set is supplied in scribing mode. However parts ③ and ④ should be assembled square to each other to reduce cutting impact. Shims, part no's ⑦ and ⑧ are used to adjust the tightness of the joint. The ball bearing diameter determines the depth of cut.

Cutter set-up for profiling

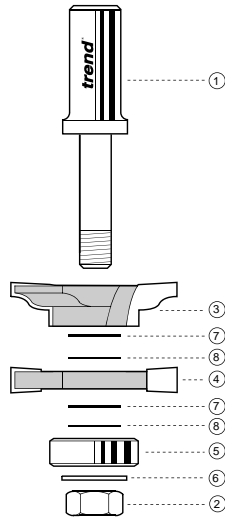

12

PROFILE SCRIBING CUTTER SETS

There are five styles of Profile Scriber Sets, each available with 6.3 or 4mm kerf groovers and on 8mm or 1/2" shank diameters.

CLASSIC SETS

Groover	Material thickness	Ref.	Shank Diameter
6.3mm Kerf	18mm to 22mm	PSC/1	8mm 1/2"
4.0mm Kerf	16mm to 19mm	PSC/10	8mm 1/2"

C149 as PSC/1 but with 6.3mm diameter shank

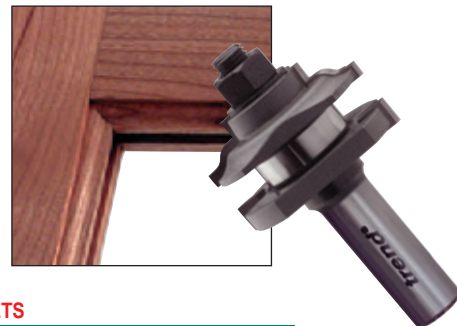

CLASSIC SETS

Groover	Material thickness	Ref.	Shank Diameter
4.0mm Kerf	18mm to 22mm	PSC/2	8mm 1/2"
6.3mm Kerf	21mm to 26.5mm	PSC/20	8mm 1/2"

14

FLAT CLASSIC SETS

Groover	Material thickness	Ref.	Shank Diameter
6.3mm Kerf	18mm to 22mm	PSC/3	8mm 1/2"
4.0mm Kerf	16mm to 19mm	PSC/30	8mm 1/2"

C156 as PSC/3 but with 1/4" diameter shank

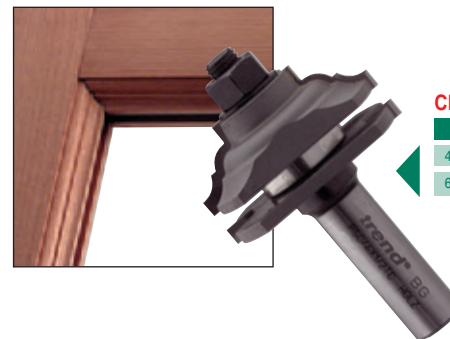

CLASSIC SETS

Groover	Material thickness	Ref.	Shank Diameter
4.0mm Kerf	18mm to 22mm	PSC/4	8mm 1/2"
6.3mm Kerf	21mm to 26.5mm	PSC/40	8mm 1/2"

BEVEL SETS

Groover	Material thickness	Ref.	Shank Diameter
6.3mm Kerf	18mm to 22mm	PSC/5	8mm 1/2"
4.0mm Kerf	16mm to 19mm	PSC/50	8mm 1/2"

C157 as PSC/5 but with 1/4" diameter shank

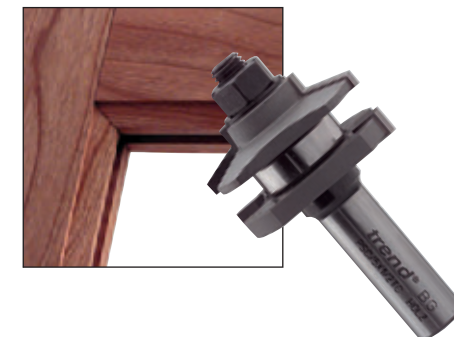

15

Which Router?

Profile Scribing operations should only be carried out using a router of 750 watts or over, fitted to an inverted or overhead routing table. Profile Scribing cutters are now available with 6.3mm (1/4"), 8mm and 12.7mm (1/2") arbor shanks, suitable for use in most current routers, although the profile variations in the smaller sizes are at present limited.

Variable Speed

Although variable speed control is recommended, it is not essential when using profile scribing cutters. It is necessary however to reduce the speed when using panel raising cutters of 50mm diameter or above.



Collet Size

An optional collet size of 8mm is now available for many routers enabling many, in particular the smaller machines, to use all the profile scribing cutter sets within the range. The 8mm shank is more rigid than 6.3mm shanks, and therefore beneficial for use in smaller routers.

Fine Height Adjuster

To allow precise adjustment of the cutter height to accurately align the mating profiles of scribed joints, it is essential to fit a fine height adjuster to the router.



13

PROFILE SCRIBER MULTI SET



Timber thickness
Min = 18mm
Max = 22mm

For use in a router
table only

The Profile Scribe Multi Set contains interchangeable cutter blocks to allow three different mould styles to be used. By using the extra groover, a 1/4" tongue and groove joint can be made. Maximum thickness of material for tongue and groove is 22mm.



PSC MULTI SET - PSC/MS1

Comprises	Qty.	Ref.
Profile Scribe Set	1	SP-PSC/1
Profile Block	1	SP-PSC/3A
Profile Block	1	SP-PSC/5A
6.3mm Groover	1	SP-34/70TC
Spare Spacer Set	1	SPACER/8

16

3

MATERIALS & OTHER EQUIPMENT

To obtain accurate results from your profile scribing and panel raising cutters, always select good quality timber and equipment.

18

MATERIALS

Before purchasing the timber for rails, stiles and panels, consider the following points:

- 1 Calculate the amount required carefully allowing for adequate waste. Remember to add extra length to stiles to leave horns to protect the corners of the door before fitting.
- 2 Take care to select straight grained timber with no dead or loose knots, matching each board for grain pattern and colour.
- 3 Always check that the timber is fully seasoned with a low moisture content to avoid excessive shrinkage.

PANEL DOOR SETS

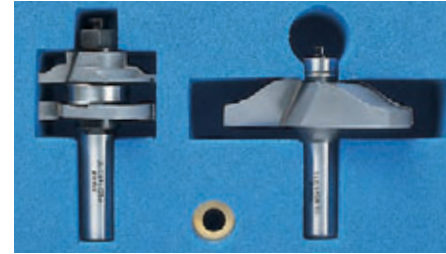

Trend panel door sets each consist of one profile scribe cutter and one matching raised panel cutter. The 1/2" shank sets are intended for use in heavy duty routers. The 8mm shank cutters can be used in routers over 750 watts, fitted with a 8mm collet. There are maximum speed constraints on the following 1/2" shank panel cutters.

18/82 & 18/83	16,000 RPM
18/80 & 18/81	12,000 RPM

PANEL DOOR SETS

Contents	Ref.	Shank Dia.
PSC/1 & 18/83	PDS/1	1/2"
PSC/20 & 18/83	PDS/2	1/2"
PSC/3 & 18/82	PDS/3	1/2"
PSC/40 & 18/81	PDS/4	1/2"
PSC/5 & 18/80	PDS/5	1/2"
PSC/1 & 18/24	PDS/10	8mm
PSC/2 & 18/24	PDS/11	8mm
PSC/5 & 18/20	PDS/12	8mm

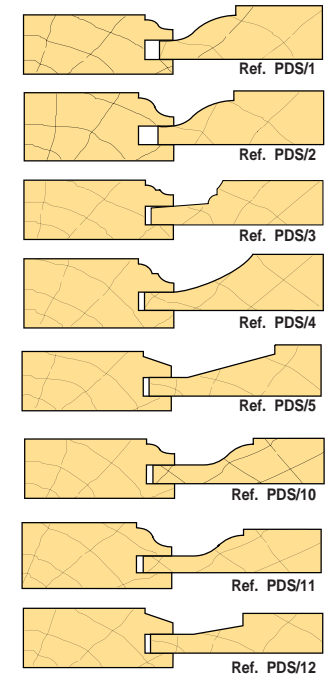

17

Preparing the timber

- 1 Cut and plane all timber to the required sizes, finishing it square and true.
- 2 Carefully cut all components to length, allowing extra length on the stiles to form horns.
- 3 Mark all face sides and edges for easy reference. This is particularly important to ensure that each piece is correctly set up on the router table for cutting the scribe and profile parts of the frame joints. It is also

helpful when alternating the grain pattern of each adjacent piece when edge jointing to form the panels (see page 234).

- 4 To avoid confusion when cutting batches of similar components, ensure that there is adequate stacking areas for feeding into and taking off, adjacent to the table.

Traditional face and edge marks applied for easy reference.

19

OTHER EQUIPMENT

Inverted Routing Table

Throughout this booklet, we show operations being carried out on the Trend 'Craftsman' router table. This table is designed to take virtually every make and model of router. Supplied with a 230 Volt No-Volt Release Switch and pushstick, it can also be fitted with a number of optional accessories.

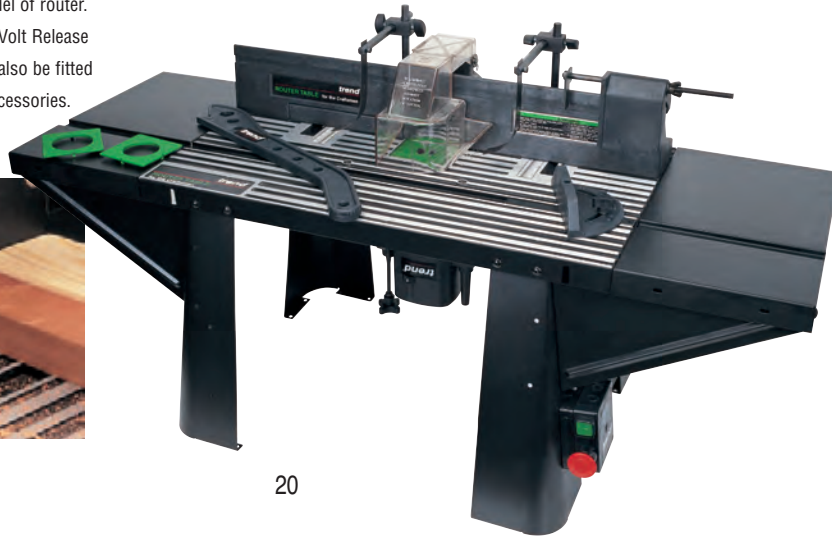

20

Please Note.
Profile scribing cannot be carried out safely or satisfactorily using the cutter assembly in a router, held and guided by hand.

Dust Extraction

Dust and waste extraction equipment is recommended for all table routing operations, particularly when routing man-made materials such as Medium Density Fibreboard (MDF). Most proprietary routing tables are fitted with an integral dust collection port in the back fence. This allows the dust and waste material to be extracted directly from behind the cutter. Many vacuum extractors allow a router (up to 1800 watts) and the extractor motor to be switched on and off simultaneously.



21

No-Volt Release Switch

It is recommended that all router tables are fitted with a No-Volt Release Switch. The switch should be secured to a leg or the table edge to provide immediate access to the on/off buttons. Should the power supply be turned off or fail at source, a No-Volt Release Switch will prevent the router from re-starting until the green on-button is pressed.



4 THE FRAME

THE SCRIBE _____ **23 - 27**
MAKING A WORKHOLDER
SETTING UP THE CUTTER
CUTTING THE SCRIBE

THE PROFILE _____ **28 - 30**
SETTING UP THE CUTTER
CUTTING THE PROFILE

SHAPED RAILS _____ **31 - 33**
WORKHOLDER FOR TRIMMING
CUTTING THE EDGE PROFILE

22

THE SCRIBE

The profile scribing cutter is first set up to cut the joint tenon and the matching reverse moulding (the scribe) to fit into the rail edge groove.

MAKING A WORKHOLDER

To cut the scribed rail ends, the rails must be presented at 90° degrees to the fence. For both accuracy and safety, it is recommended that a purpose made workholder is used.

- 1 Cut a 6mm baseboard, at least 75mm wide (to prevent the workpiece turning or snatching as it enters and leaves the cutter).

- 2 Screw an end stop to the baseboard to form a precise right angle to the fence.
- 3 Screw a toggle clamp to the stop batten to hold the workpiece firmly. The stop batten also acts as a splinch block to prevent breakout as the cutter breaks through. Alternatively, a parallel waste batten can be held between the rail and stop batten to perform a similar function.



23

If your table is fitted with a sliding mitre fence, it is still advisable to use a workholder of this type to support the workpiece, rather than holding it against the face of the mitre fence.



SETTING UP THE CUTTER

When forming scribed frame joints it is common practice to cut the scribed rail ends first. This eliminates the breakout that would otherwise occur on one end of each stile when cutting the edge moulding and groove. Our profile cutters are therefore supplied arranged for cutting the scribe.

- 1 On first use or when reassembling the cutters on the arbor, position the cutters (parts 3 & 4, as shown on page 208) at 90° degrees to each other and check that the arbor nut is tight. Do not hold the cutter assembly in a vice or with pliers etc, as this will damage the cutting edges or shank.

Always machine the timber with the cutters set in this way (as below).

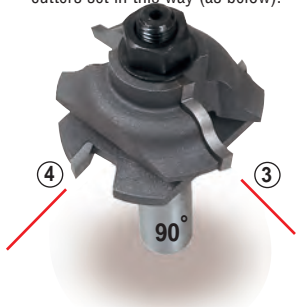

24

Make a Trial Joint

Before using your profile scribing cutters on a specific project, always cut a series of trial joints using waste material, the same dimensions as that to be used for the stiles and rails. Having cut a successful well fitting sample joint, keep it in the workshop for reference on future projects.

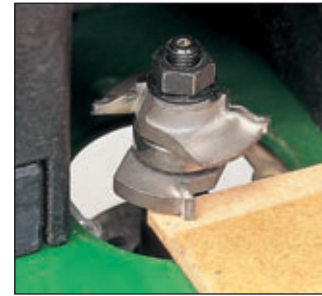

2 Adjusting the Height

Fit the cutter assembly into the router ensuring that at least three quarters of the shank length is gripped in the collet. Set the height of the cutter above the table allowing the bottom edges of the cutter to cut slightly into the top face of the baseboard.

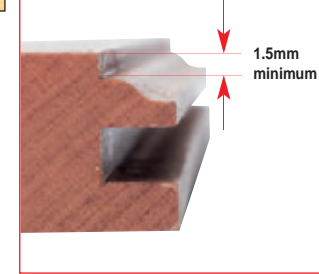

3 Setting the depth of the Quirk

When setting the cutter height be sure to leave an adequate depth quirk on the moulding of at least 1.5mm. Any less will result in a weak edge that may lose definition when sanded or painted.

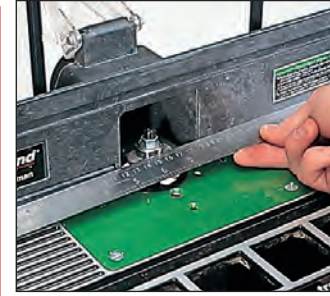

4 Aligning the cutter

To align the fence and ball bearing, loosen the fence clamping screws and apply a steel rule across the faces. Slide the fence back until the rule edge touches the bearing. On tables with adjustable facings, close these to leave approximately 3mm either side of the cutter to allow waste to clear freely.

25

CUTTING THE SCRIBE

Make the following checks:

- 1 Check that all guards are fitted, correctly positioned and secured.
- 2 Check the dust extractor is connected.
- 3 Remember to position the rail in the workholder **FACE-SIDE UP** when cutting the Scribe.
- 4 Check that the collet and arbor nuts are secure.
- 5 Check that the cutter will revolve freely and that there is clearance around the cutter for chips to clear.

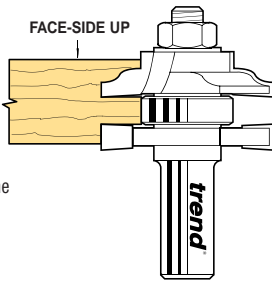

Save Time

To avoid re-assembling the cutter unnecessarily, cut all the scribed rail ends first. Then change the cutter set-up to cut the stile edge profiles.



- 1 Clamp the rail in the workholder, aligning one end against the fence. Slide the workholder up to the face of the in-feed fence, keeping your hands away from the cutter.

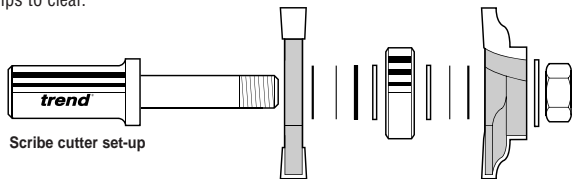

Scribe cutter set-up

26

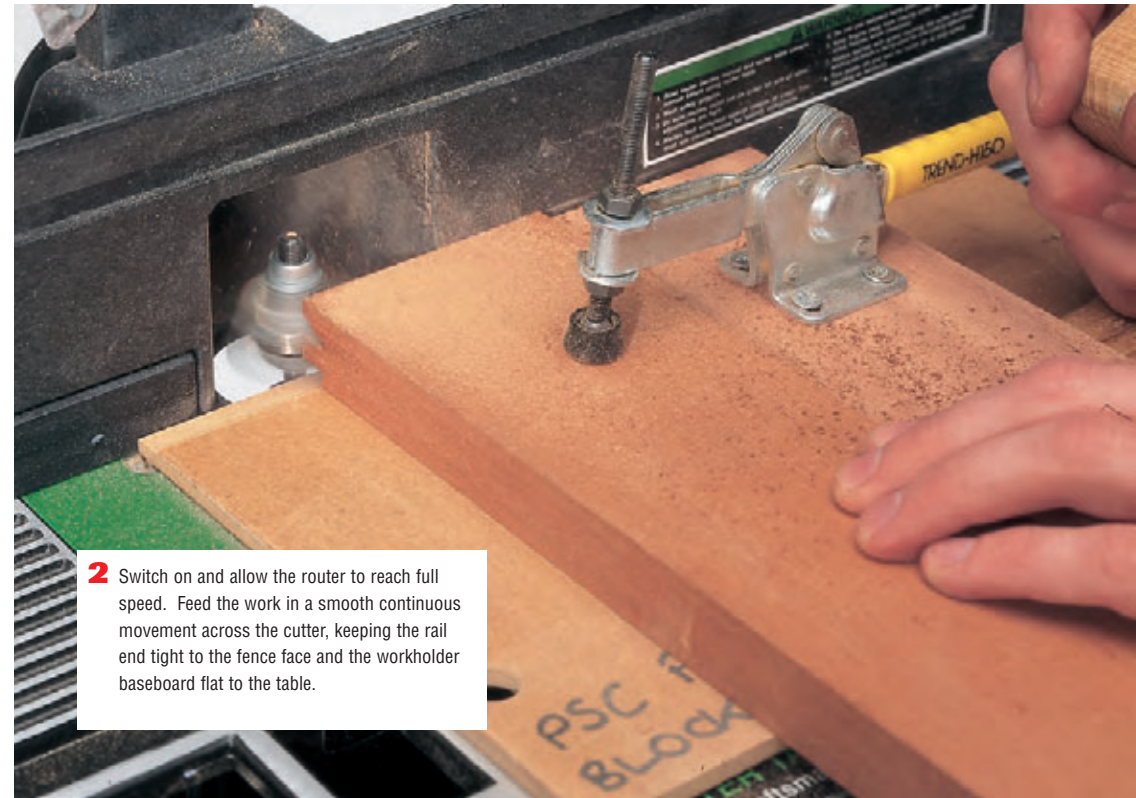

- 2 Switch on and allow the router to reach full speed. Feed the work in a smooth continuous movement across the cutter, keeping the rail end tight to the fence face and the workholder baseboard flat to the table.



THE EDGE PROFILE

By re-assembling the profile scribing cutter, the edge moulding and panel groove can be accurately cut to produce a precise and strong joint.

SETTING UP THE CUTTER

For profiling the rail and stile edges, set up the cutter in the following sequence:

- 1 Disconnect the router from the power source.
- 2 Leave the arbor in the collet and use the routers spindle lock or spanner to prevent it turning while undoing the nut.

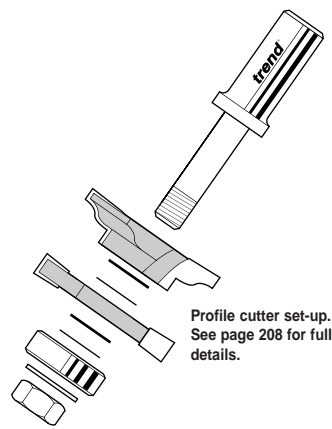
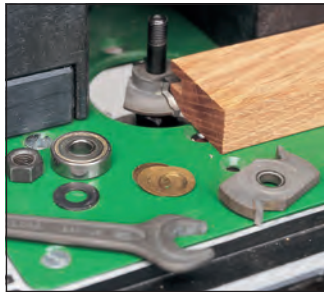

Profile cutter set-up. See page 208 for full details.

- 3 Re-arrange the cutter components in the correct order for cutting the edge profile.
- 4 Fit the shims between the cutter components using the scribed rail ends as a guide.
- 5 Loosely tighten the arbor nut for the moment.

28

- 6 In order to reduce the depth of cut when using 1/4" shank cutters, the fence should be set forward of the bearing face for the first pass, then aligned with it for the final one.



- 7 If fitted, close the adjustable fence facings to leave a gap of approx. 3mm either side of the cutter.
- 8 Lay the pre-cut scribed rail end on the table, **FACE-SIDE DOWN** (i.e. opposite way up than when cutting the scribed rail ends).
- 9 Adjust the cutter height using the fine adjuster and match the reassembled

cutter profile to the scribed profile, aligning the groover with the stub tenon and the quirk with the profile block.

- 10 Remove or re-arrange the shims between the cutter components to tighten or loosen the joint and adjust the cutter height to leave the rail and stile faces flush.

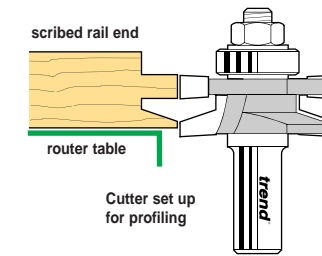

- 11 Ensure the fence is aligned with the bearing using a steel rule as before.



Pressure Clamps

For both accuracy and safety, it is recommended that vertical and/or horizontal pressure clamps (hold down clamps) are fitted. These must be adjusted to maintain firm pressure between the fence or table and the timber, but still allow the work to be fed smoothly and evenly across the cutter. Always use a push stick or workholder to feed the work into and out of the cutter.

29

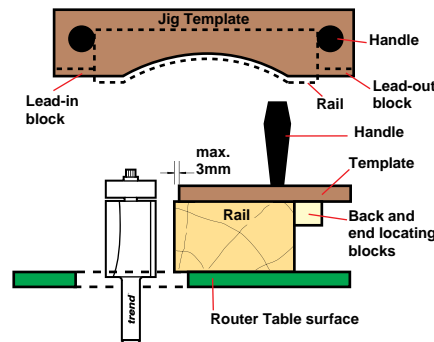
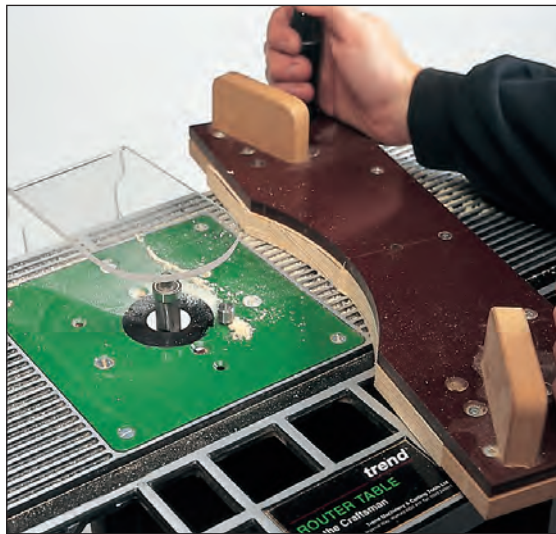

- 4 A suitable guard must be fitted above the exposed cutter when carrying out any template profiling operation.
- 5 Switch on and carefully feed the workholder into the cutter via the lead-on pin. Make a second pass to ensure a clean cut has been produced.

32

CUTTING THE EDGE PROFILE

The sequence for cutting the profile on shaped and curved rails and stile edges is as follows:

- 1 Replace the trimming cutter with the profile scribing cutter arranged to cut the edge profile.
- 2 Use the pre-cut scribed rail end to set the cutter height.
- 3 Re-fit the cutter guard and locate a trial workpiece in the workholder, with the **FACE-SIDE DOWN** to the table (as for edge profiling straight rails).
- 4 Starting with the lead-in block of the workholder resting against the lead-on pin, feed it into the cutter. Follow through in a smooth continuous movement along the length of the rail and partially into the lead-out block.

- 5 Check that the trial piece produces a flush joint when assembled, before cutting the remaining rails.

The curved rail edge after cutting the moulding and groove.

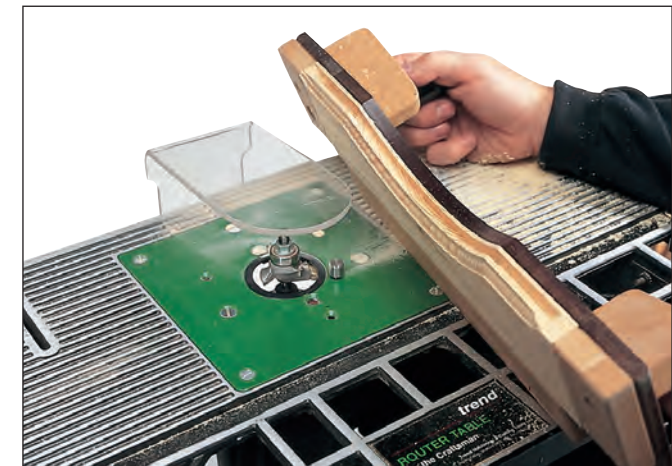

33



THE EDGE PROFILE

By re-assembling the profile scribing cutter, the edge moulding and panel groove can be accurately cut to produce a precise and strong joint.

SETTING UP THE CUTTER

For profiling the rail and stile edges, set up the cutter in the following sequence:

- 1 Disconnect the router from the power source.
- 2 Leave the arbor in the collet and use the routers spindle lock or spanner to prevent it turning while undoing the nut.

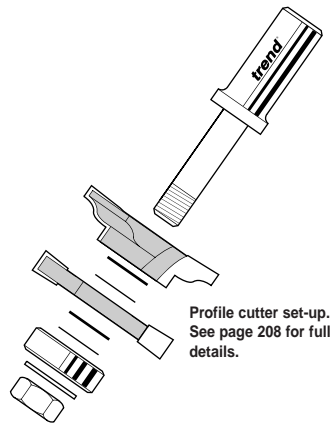

Profile cutter set-up. See page 208 for full details.

- 3 Re-arrange the cutter components in the correct order for cutting the edge profile.
- 4 Fit the shims between the cutter components using the scribed rail ends as a guide.
- 5 Loosely tighten the arbor nut for the moment.

28

CUTTING THE PROFILE

- 1 Check that all guards are fitted, correctly positioned and secured.
- 2 Check that the dust extractor is connected.
- 3 Switch on and allow the router to reach full speed.
- 4 Position the workpiece **FACE-SIDE DOWN** with the **FACE-EDGE** against the back fence, clear of the cutter.

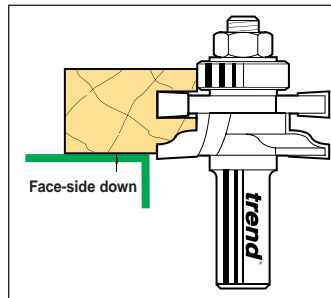

Cutting the edge profile on the trial piece

- 5 Slide the workpiece under the in-feed pressure clamp.
- 6 Using the pushstick or a workholder, feed the rail across the cutter in a smooth continuous movement, keeping the rail tight to the fence face.



30

- 6 In order to reduce the depth of cut when using 1/4" shank cutters, the fence should be set forward of the bearing face for the first pass, then aligned with it for the final one.



- 7 If fitted, close the adjustable fence facings to leave a gap of approx. 3mm either side of the cutter.
- 8 Lay the pre-cut scribed rail end on the table, **FACE-SIDE DOWN** (i.e. opposite way up than when cutting the scribed rail ends).
- 9 Adjust the cutter height using the fine adjuster and match the reassembled

cutter profile to the scribed profile, aligning the groover with the stub tenon and the quirk with the profile block.

- 10 Remove or re-arrange the shims between the cutter components to tighten or loosen the joint and adjust the cutter height to leave the rail and stile faces flush.

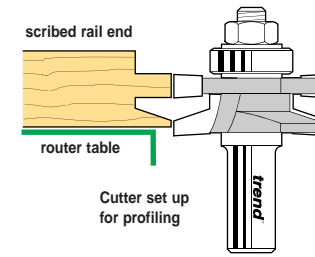

29

- 11 Ensure the fence is aligned with the bearing using a steel rule as before.



Pressure Clamps

For both accuracy and safety, it is recommended that vertical and/or horizontal pressure clamps (hold down clamps) are fitted. These must be adjusted to maintain firm pressure between the fence or table and the timber, but still allow the work to be fed smoothly and evenly across the cutter. Always use a push stick or workholder to feed the work into and out of the cutter.

WORKHOLDER FOR TRIMMING



SHAPED RAILS

When cutting curved and shaped rails, it is advisable to make up a combined template and workholder to ensure safety and accuracy.

When profile-scribing curved and shaped rails, it is advisable to cut the scribed joint before shaping the rail edge. The rail edge can

then be cut to the required curve or shape using a template/workholder, with its leading (guide) edge cut to the required curve or shape. For safe handling, the workholder is fitted with handles and/or guards and is initially used to trim the rail against a bearing guided trimming cutter.

A rear locating batten and lead-in and lead-out end blocks, fitted to the underside of the template, locate the workpiece beneath the template.

The template must be cut overlength to allow the cutter to be fed smoothly into and away from the cutter. A lead-on pin or piece should be fitted to the table to prevent the end of the workpiece from being snatched into the cutter.

Trimming the rail to shape:

- 1 Roughly cut the rail to shape with a jigsaw or bandsaw, taking care not to damage the scribed rail ends. Leave a maximum of 3mm for trimming.
- 2 Ensure that the rail is gripped in the workholder, if necessary locating it with veneer pins or double sided tape.
- 3 Fit a trimming cutter which has a suitable length of cut.

31

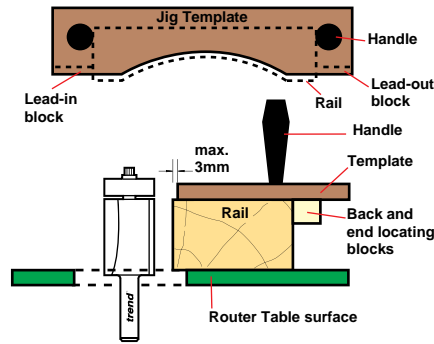

- 4 A suitable guard must be fitted above the exposed cutter when carrying out any template profiling operation.
- 5 Switch on and carefully feed the workholder onto the cutter via the lead-on pin. Make a second pass to ensure a clean cut has been produced.

32

CUTTING THE EDGE PROFILE

The sequence for cutting the profile on shaped and curved rails and stile edges is as follows:

- 1 Replace the trimming cutter with the profile scribing cutter arranged to cut the edge profile.
- 2 Use the pre-cut scribed rail end to set the cutter height.
- 3 Re-fit the cutter guard and locate a trial workpiece in the workholder, with the **FACE-SIDE DOWN** to the table (as for edge profiling straight rails).
- 4 Starting with the lead-in block of the workholder resting against the lead-on pin, feed it into the cutter. Follow through in a smooth continuous movement along the length of the rail and partially into the lead-out block.

- 5 Check that the trial piece produces a flush joint when assembled, before cutting the remaining rails.

The curved rail edge after cutting the moulding and groove.

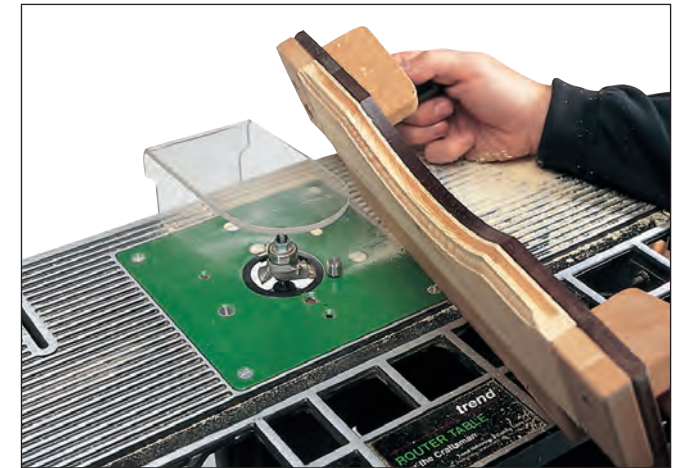

33

5 THE PANELS

PANEL STYLES	35
JOINTING	36 - 37
ASSEMBLING	38 - 39
TRIMMING	40 - 41

Profile scribed frames can be fitted with either plain or decorative moulded panels made from solid timber or timber based sheet materials.

However, all panels must be of stable materials or constructed to eliminate any excessive movement that may result in twisting or warping of the panel and frame, or shrinkage of the panel within the frame. Panels must be of suitable thickness for the overall frame size and have a finished edge thickness that is a sliding fit in the panel groove, but not too tight as it may cause the rear groove edge to curl outward.

Where the panel material is thicker than the panel groove, the edge can be either rebated on one or both faces, or raised and fielded on the front face, using panel raising cutters.

34

PANEL STYLES

Plain flat panels

Cut from Medium Density Fibreboard (MDF), plywood or other timber based sheet material. These materials can either be veneered to match the frame timber or left plain for painting.

Tongue and groove match boarding

Either v-jointed or with a bead profile, the boarding can be cut to length and if thicker than the groove, rebated to fit.

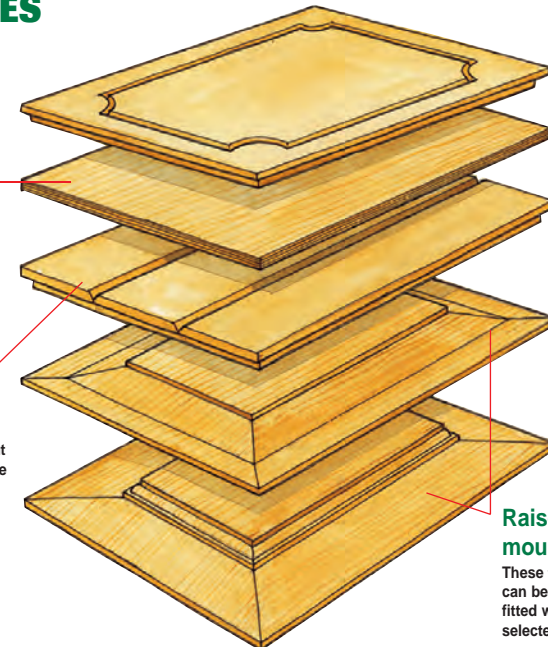

Relief moulded Panels

Cut from MDF sheet, these have a decorative relief moulding cut into the surface, either to form a boarder parallel to the edges or as a pattern across the panel surface. Panel moulding cutters are used to machine the moulding, guided by a template and guide bush, straight edge or the side fence.

Raised, fielded and moulded panels

These traditional panel boarders can be simply cut using the router fitted with a panel raising cutter selected from the Trend range.

35

JOINTING

The four most common methods used for jointing panels are traditional rubbed joints, biscuit dowelled joints, round dowelled joints and loose tongue joints.

Rubbed joints

These are formed by planing the mating edges perfectly straight and true before applying glue and rubbing the two edges together to spread the glue evenly. The joint is then clamped until dry.

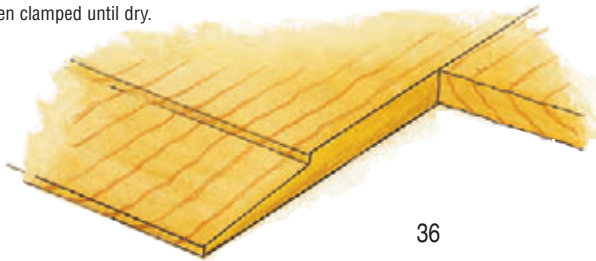

ASSEMBLY

When joining solid timber boards or strip, edge-to-edge to form panels, alternate the direction of the growth rings to minimise cupping and bowing across the glued-up board.

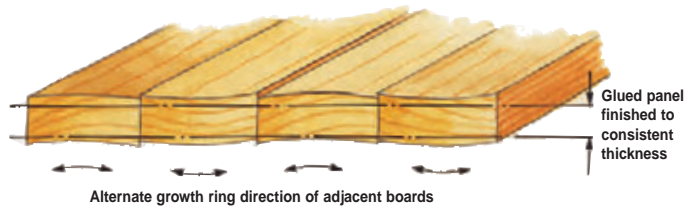

Preparing the Timber

Each pair of mating edges must be planed straight and square to ensure that the joint will be virtually invisible and that the panel will be flat when released from the cramps.

Carefully arrange adjacent boards or strips so that the grain pattern along the joint lines blends and follows the same direction. Alternatively arrange the grain pattern to produce decorative book matched or 'flame' pattern effects.

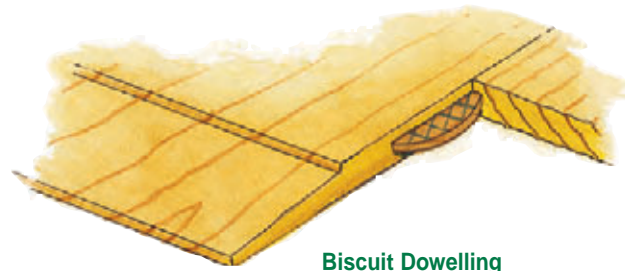

Biscuit Dowelling

Biscuit or elliptical beech dowels, can be used to reinforce edge-to-edge panel joints. The dowels are set into semi-circular recesses cut with the router fitted with a suitable grooving cutter (See Trend Biscuit Cutter Set, Ref. 342). The dowel positions are carefully set out at approx 150mm centres along the joint faces, but carefully avoiding the width of the panel raising mould at each end of the panel.

Round Dowels

Small diameter (6mm) round dowels are inserted into equally spaced holes drilled along the joint edges, using a proprietary doweling jig. This ensures that the holes are drilled at right angle to the edge and correctly aligned. Lip and spur dowelling drills, for use in drilling machines and routers, and splined dowels (grooved to allow excessive glue to be released) are available from Trend.

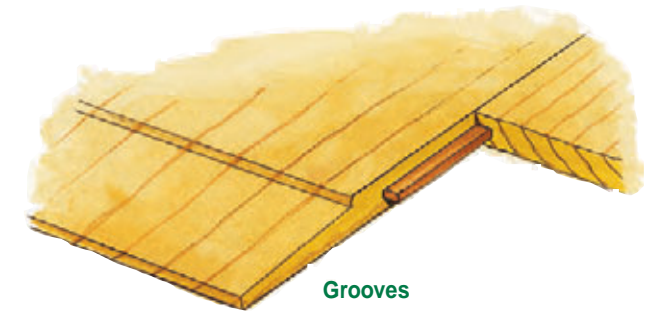

Grooves

A router can be used to cut grooves for loose tongues, 6mm into each mating edge, using either a narrow straight cutter, guided by one or two side fences to centre the cutter across the timber, or a ball bearing guided grooving cutter. Stop the groove clear of the panel mouldings at each end to avoid showing the groove on the face of the panel raising. Secure the joint with a 10 mm wide cross grain tongue, equal in thickness to the groove width.

Gluing and Cramping

In order to keep thin panels flat while gluing and cramping:

- 1 Cut two pieces of thick sheet material (MDF, Plywood, Chipboard etc.), slightly smaller than the assembled panel.
- 2 Cover the boards with polythene sheet to prevent excess gluing adhering to them.
- 3 Glue the edges and assemble the panel on one board.
- 4 Lay the other board over it and position cramps around the perimeter, but do not fully tighten.
- 5 Use sash cramps or webbing straps to pull the panel joints tight before finally tightening the edge cramps.
- 6 When dry, release the cramps and

plane and/or sand the surface flat on one face. Mark the finished panel thickness along each edge and plane/sand the other face. Ensure that all traces of glue are removed from both surfaces.

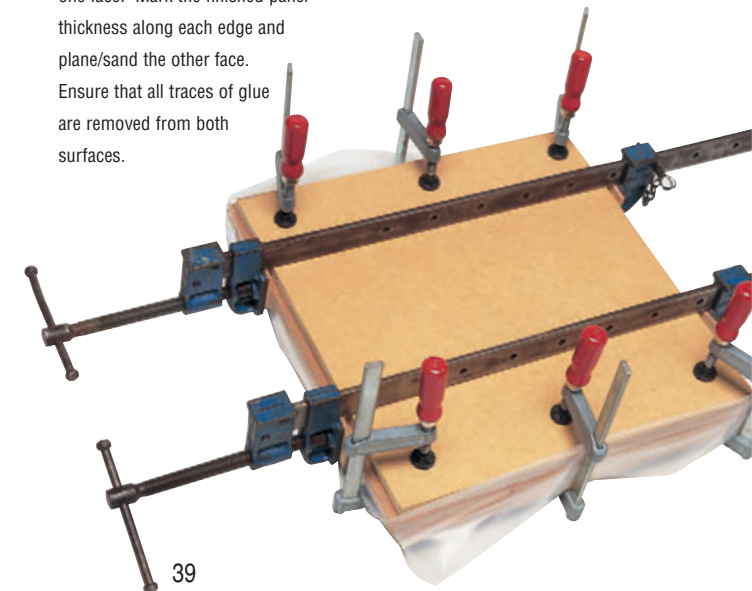

CALCULATING THE PANEL SIZE

Assemble and clamp each frame and measure the inside dimensions using a tape measure or by marking off along a straight batten (setting out rod).



1 For solid timber frames and panels, add to the length of the panel

(following the grain direction) twice the depth of the panel groove minus 2mm. Add to the width of the panel (across the grain) twice the depth of the panel groove minus 6mm. This is to allow for movement across the width of the panel (the direction in which most movement will occur) while preventing it from dropping vertically.

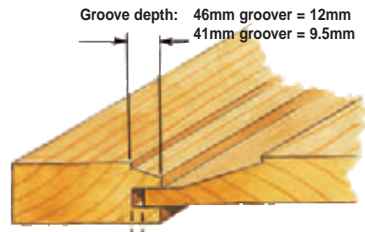

40

2 Alternatively a 6mm margin can be deducted from both dimensions, but this may require the panel to be fixed in the panel grooves to prevent it from dropping (see page 255).

For solid timber panels allow: Rails 3mm
Stiles 1mm
For MDF or Plywood panels allow 1mm clearance all round

Always ensure that the edge thickness/profile produces a sliding fit in the groove.

3 Frames and panels made from stable timber based materials (i.e. MDF) can be cut to fit. These panels can then be glued directly into the frames.

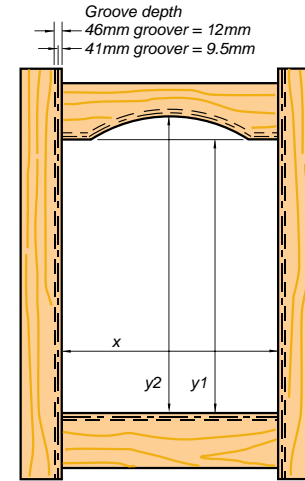

41

4 Plane one edge of the panel straight and finish one end at right angles to it.
5 Transfer the dimensions then cut and plane the panel to size, finishing the edges square and parallel.

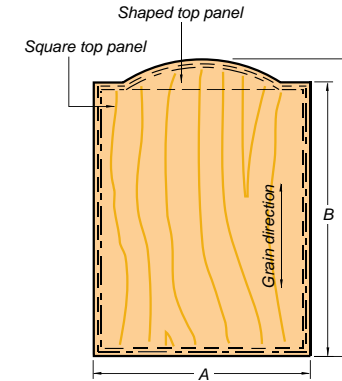

Panel margins for calculating overall panel sizes when using profile scribing cutter fitted with either 46 or 41mm groovers.

For solid timber panel:
46mm diameter groover =
 $A = x + (2 \times 12\text{mm}) - 6\text{mm}$
 $B \text{ or } C = y1 \text{ or } y2 + (2 \times 12\text{mm}) - 2\text{mm}$
41mm diameter groover =
 $A = x + (2 \times 9.5\text{mm}) - 6\text{mm}$
 $B \text{ or } C = y1 \text{ or } y2 + (2 \times 9.5\text{mm}) - 2\text{mm}$

For plywood or MDF (i.e. stable materials):
46mm diameter groover =
 $A, B \text{ or } C = x, y1 \text{ or } y2 + (2 \times 12\text{mm}) - 1\text{mm}$
41mm diameter groover =
 $A, B \text{ or } C = x, y1 \text{ or } y2 + (2 \times 9.5\text{mm}) - 1\text{mm}$

6 RAISED PANEL MOULDING CUTTERS



The traditional panels for the doors can be routed using panel raising cutters held in a fixed position router. The router can be mounted either overhead or inverted in a table. The material is then passed into the cutter in a series of shallow passes to build up the mould.

42

VERTICAL	43
BEARING	44
HORIZONTAL	45
RADIUSED	46
OGEE	47
OVOLO & CLASSIC	48
BEVELLED	49

VERTICAL RAISED PANEL CUTTERS



When using vertical panel raising cutters in inverted routers, it may be necessary (not on Craftsman router table) to fit an extended height false face to the back fence, to support the workpiece vertically.

A deep horizontal front pressure guard or vertical support will help ensure safety and accuracy by keeping the bottom edge of the workpiece flat against the fence face.



Positioning the vertical front support block

43

BEARING GUIDED RAISED PANEL CUTTERS



Straight, or shaped panels can be moulded (raised) by running the panel against the ball bearing or the edge of a template mounted above or below it. However, the edge of the panel must be finished as a smooth, continuous edge, as the ball bearing will follow any unevenness, repeating it on the finished moulding. If required, the back fence can be used when cutting straight edged panels to provide additional stability. When cutting curved work, the ball bearing can be run against either the shaped workpiece itself or against a template (cut from 6.3mm thick material (MDF, solid laminate etc.), fixed to the top face of the workpiece with a purpose made jig, pins or double sided tape.



Initially, templates can be cut using a trammel or ellipse jig, relying on the router cutter to leave a smooth square edge. Alternatively, the template can be cut with a jigsaw and the sawn edge finished square with a plane or abrasive. When using ball bearing guided cutters on an inverted router table, it is necessary to fit a false table top to allow the cutter to sit fractionally below the surface. (See page 247).

44

HORIZONTAL RAISED PANEL CUTTERS



Large diameter horizontal raised panel cutters are used for moulding straight edges against the table fence. It is advisable to use them only in table mounted variable speed routers at their recommended safe speed. Cutters above 50mm in diameter, should be used at speeds not exceeding 18,000 rpm, above 70mm diameter at 16,000 rpm and above 80mm in diameter at 12,000 rpm.

When using horizontal raised panel cutters, never cut to the full depth in one pass. The full depth should be reached in a series of shallow passes, using the routers turret

stop to increase the cutting depth for each. Likewise, wider mouldings can be produced by resetting the fence to allow the cutter to cut in a series of passes cutting further in from the edge on each pass. When using a router table with a cutter aperture smaller than the cutter diameter, always fit a false top to allow the cutter to be set slightly lower than the surface (see page 247).

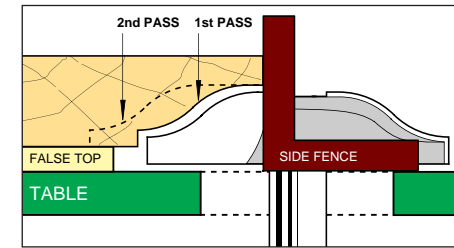

45

RADIUSED PANEL MOULDING CUTTERS

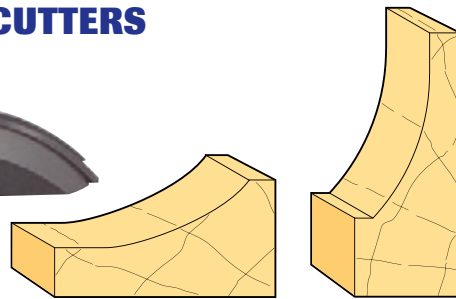

Ref. 18/81

Ref. 18/91

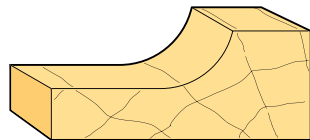
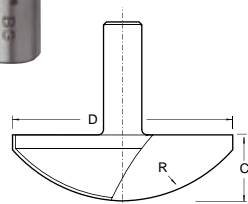

Ref. 18/21

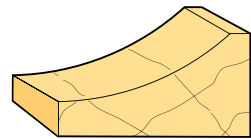

Ref. 18/18

RADIUSED PANEL MOULDING CUTTERS

Ref.	R	D	C	Shank Diameter
18/81	40mm	86mm	12.7mm	1/2"
18/91	40mm	28.5mm	38mm	8mm & 1/2"
18/21	14mm	50mm	14mm	1/2"
18/18	50mm	73mm	22mm	1/2"

46

OGEE PANEL MOULDING CUTTERS

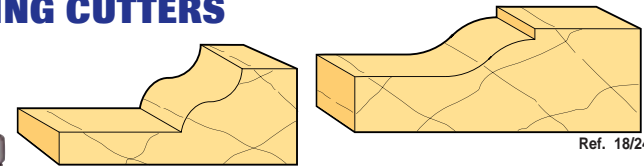

Ref. 18/23

Ref. 18/24

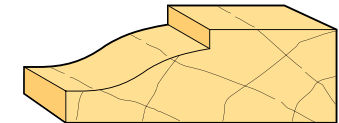

Ref. 18/83

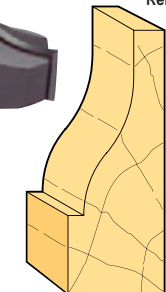

Ref. 18/93

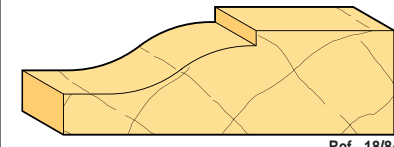

Ref. 18/84

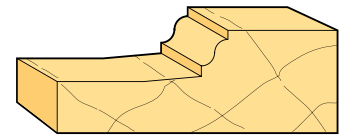

Ref. 18/25

OGEE PANEL MOULDING CUTTERS

Ref.	R	D	C	Shank Diameter
18/24	12mm	50mm	14mm	1/2"
18/83	17.5mm	67mm	16mm	1/2"
18/23	6mm	50mm	14mm	1/2"
18/93	22mm	30mm	38mm	8mm & 1/2"
18/84	22.2mm	85.7mm	15.9mm	1/2"
18/25	3mm	50mm	14mm	1/2"

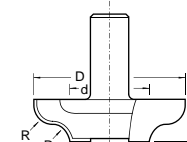

47

MODERN OVOLO & CLASSIC MOULD PANEL CUTTERS

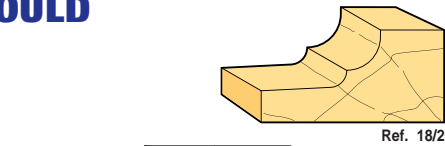

Ref. 18/26

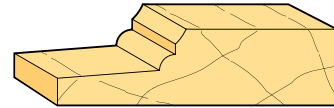

Ref. 18/82

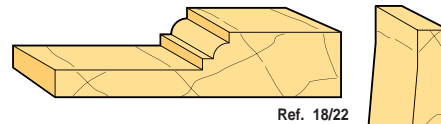

Ref. 18/22

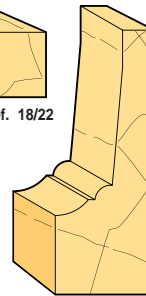

Ref. 18/92

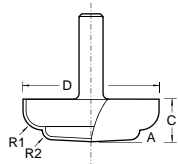

MODERN OVOLO & CLASSIC MOULD PANEL CUTTERS

Ref.	A	R1	R2	D	C	Shank Diameter
18/26	3°	6.3mm	3.2mm	45mm	13.5mm	8mm
18/82	5°	8mm	3mm	63.5mm	12.7mm	1/2"
18/22	-	3mm	-	50mm	14mm	1/2"
18/92	85°	3mm	8mm	25.4mm	38mm	8mm & 1/2

48

BEVEL MOULD RAISED PANEL CUTTERS

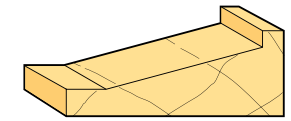

Ref. 18/80

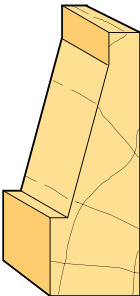

Ref. 18/90

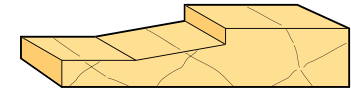

Ref. 18/20

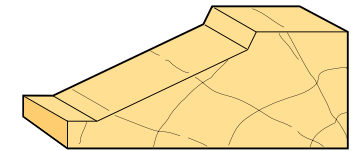

Ref. 18/19

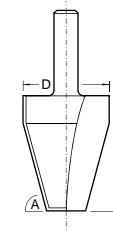

BEVEL MOULD RAISED PANEL CUTTERS

Ref.	A	D	C	Shank Diameter
18/80	15°	86mm	12.7mm	1/2"
18/90	75°	28.5mm	38mm	8mm & 1/2"
18/20	10°	50mm	17mm	1/2"
18/19	25°	69mm	19mm	1/2"

49

7

USING RAISED PANEL CUTTERS



Raised panel cutters are used to cut away the panel edge to fit into the rail or stile groove, producing a decorative bevel, radius, ogee or ovolo moulding.

SETTING UP _____	51
MAKING A TEMPLATE _____	52
COMBINED JIG _____	54
SCORING _____	55
LEAD-ON PIECE _____	56

50

SETTING UP

Before using cutters larger in diameter than the router table aperture, it may be necessary to lay a false top over the bottom of the cutting edges to be set lower than the table surface.

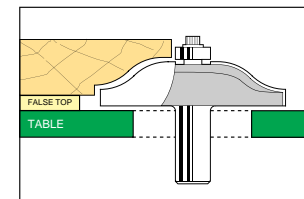

- 1 Cut a piece of 6 to 12mm medium density fibreboard (MDF) to the same size as the table top.
- 2 Place it over the router table top and

mark out any existing holes that can be used to fasten the false top. If not, set out two suitable positions to take fixing bolts.

- 3 Drill and counter-bore the fixing holes in the false top to match the holes in the existing top.
- 4 Mark the centre point of the existing table cutter aperture on the false top and drill/cut fixing holes or slots for the existing back fence.
- 5 Add 6mm to the diameter of the cutter and cut the cutter aperture to that diameter.
- 6 Fasten the false top on the table.
- 7 With the router disconnected from the power source and the fence removed, fit the cutter from above,

ensuring that there is a minimum of three quarters of the shank length held in the collet and that the bottom edges are set fractionally below the surface of the false top (not touching the router table).



- 8 Refit the back fence (replacing the mounting bolts with longer ones as necessary) and mount the holding down guards. Check that all are correctly adjusted and secure.

51

MAKING A TEMPLATE

For accuracy, curved and shaped panels should be cut using a template cut to fit into the frame. This reduces the risk of ruining the actual panel material and speeds up the work when cutting several or a batch of similar panels.

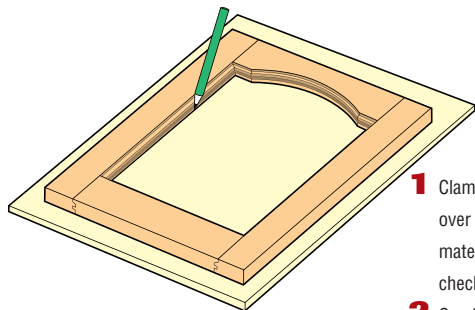

- 1 Clamp the dry assembled door frame over a piece of 6mm thick sheet material (plywood, MDF etc.) and check that it is square and flat.
- 2 Carefully draw round the inside edge.

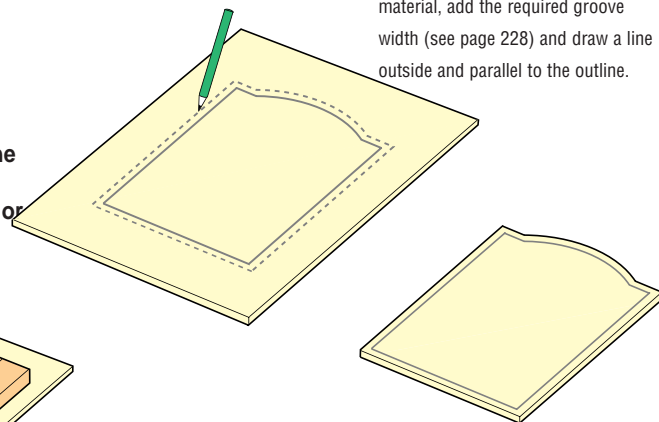

- 3 To the outline drawn on the template material, add the required groove width (see page 228) and draw a line outside and parallel to the outline.

- 4 Carefully cut around the outer line with a jigsaw, or for regular curves, with the router fitted with a beam trammel.

- 5 Finish the straight edges with a plane and the curved or shaped edges with a spokeshave or abrasive. Check that all edges are smooth, as any unevenness will be repeated on the finished work when trimming with a ball bearing guided cutter.
- 6 Check that the margins are correct by re-assembling the frame, with the template fitted.
- 7 Lay the template on the uncut panel and mark out the outline.

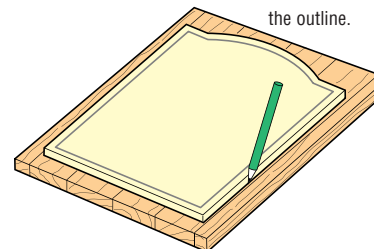

- 8 Cut the panel roughly to shape with a jigsaw or band saw.

TRIMMING TO SIZE



- 9 Trim the panel flush to the template edge using a ball bearing guided template profiling cutter. Although the router is shown fitted to an inverted router table, it can also be used for trimming in hand-held mode.

52

COMBINED JIG

A combined jig for cutting both the rail and panel shape can be made, consisting of two matching templates fitted to a baseboard.



Templates can be cut from Birch multi-core plywood, MDF or preferably solid laminate sheet to the required shape or curve. For safety and accuracy extend the curve either side of the required length or shape. These lead-in and out sections, allow the cutter to enter and leave the work smoothly without snatching. The template can be pinned to the component into the waste of the stub tenon to avoid marring the face of the wood. Cut the curved rail/panel using a ball bearing guided straight profiling cutter.

54

SCORING

After trimming and squaring the panels, select and mark the face side. Whether cutting straight, curved or shaped edges, always cut the raised edge moulding, first across the grain before cutting the moulding along it. This will remove any break out left by the cross grain cut.



If the cutter persists in tearing the grain, score across the cut line with a sharp knife, the width of the cutter in from the edge of the workpiece (i.e. distance from the outer tip of the cutter to the bearing or fence).

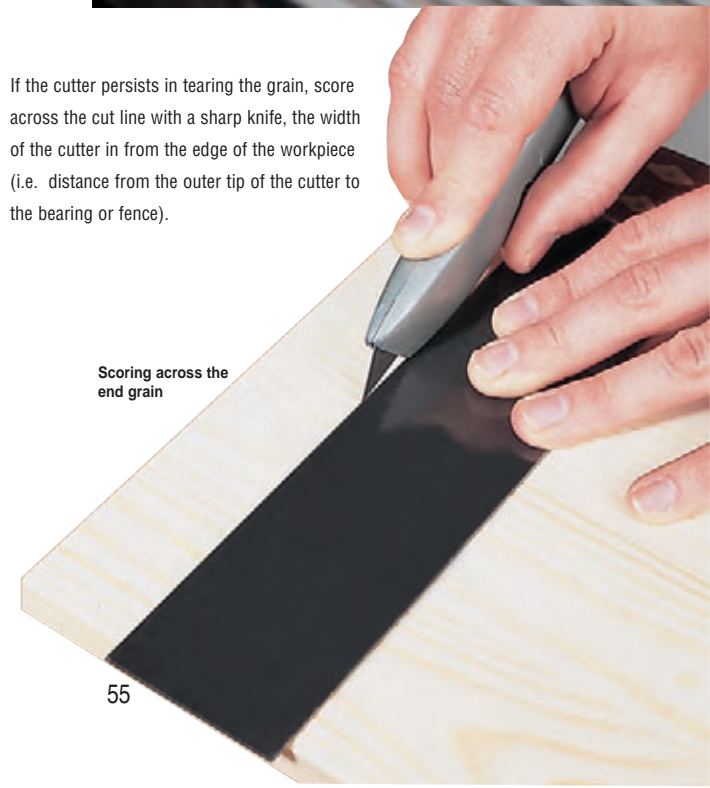

Scoring across the end grain

55

LEAD-ON PIECE

When moulding curved or shaped raised panel edges, using ball bearing guided cutters, a lead-on pin (as on our Craftsman table) or lead-on piece, must be fitted to prevent the work from being snatched into the cutter.

A lead-on piece can be cut in the workshop from waste plywood or hardwood and securely mounted on the router table (or the false top). The lead-on piece should be fitted close to the cutter to provide a rest or pressure block so that the workpiece can be steadied against as it is fed into the cutter. A lead-off piece can also be fitted to support the work as it leaves the cutter.

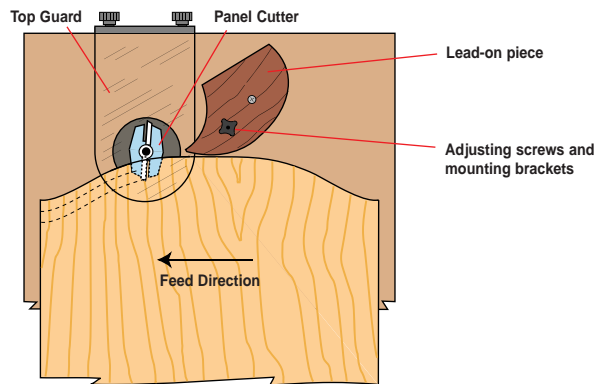

56

SUMMARY OF SAFETY TECHNIQUES

Preparation:

- Always use guards to ensure there is no possibility of fingers contacting the cutter should your grip slip or the cutter snatch.
- If in doubt always take more shallow passes rather than fewer deeper cuts.
- Reduce the speed of the router when using cutters over 50mm in diameter.
- Use a lead-on pin when carrying out curved work.
- Measure twice cut once.
- Take care when handling cutters as they are sharp and can easily cause injury.
- Always switch off the router and isolate from the mains supply before changing cutters or making adjustments to the router, table or machining set-up.
- Before reconnecting to the supply, make sure that the power switch is in the OFF position (fit a no-volt release

switch to inverted or overhead tables).

- Ensure that all power leads are clear of the table and cutter. Check they cannot catch on the work or workholder or interfere with the movement of, or trip the operator.
- Always wear eye protection such as goggles or a full face visor. Always wear ear defenders particularly if routing for lengthy periods.
- Do not wear loose clothing or jewellery that can catch or snag on cutters or equipment. Always tie back long hair.

Final checks:

- Check that all guards are correctly and securely fitted.
- Check that the dust extraction is connected.
- Check that the cutter is correctly fitted (i.e. at least 3/4 of the shank

length is held in the collet).

- Ensure groovers are correctly assembled and nut is tight.
- Practice the cutting procedure before switching on the router.
- Keep fingers clear of the cutter and never touch the router or cutter to slow the machine down.
- Do not switch on the router with the workpiece in contact with the cutter.
- Always feed the timber into cutter to oppose the direction of the cutter.

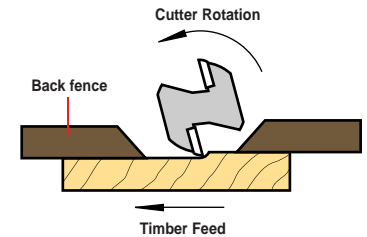

57

8

DOOR ASSEMBLY

Care and attention is essential when gluing and assembling doors, in order that they remain square and true when fitted. Always apply glue sparingly to avoid leaving traces on surfaces that are to be varnished.

Before gluing the work together, assemble the frame dry and mark each piece of each joint for easy reference.

- 1 Check that the panels will fit into the grooves without being forced, otherwise the whole door will be difficult to assemble and edges may split away.
- 2 All of the surfaces that cannot easily be sanded after assembly, should be finished before gluing up. Be careful when sanding the inside edges that the location marks for the rails are not sanded away.
- 3 Prior to gluing, place battens across the top of the bench for the door to rest on. This will allow the cramps to be positioned far more easily. The top edge of the battens must be perfectly level in order that the door will be flat when cramped.

58

Gluing the panels

Unless made of MDF or other stable material, panels should not be glued into the frame. However, it is possible to secure timber panels with two brass veneer pins at the centre or each rail. This allows for movement of the timber while the pins prevent the panel rattling in the frame should it shrink.

Pinning the panel

Do take care when inserting pins, not to split the thin groove edge. Preferably drill fine pilot holes and drive the pins at an angle into the thicker part of the edge moulding. File and punch the pins below the surface. As an allowance has been made for the panel to move, make sure it is centred and square before pinning it into the frame.

Clamping

- 1 To protect the surface from the cramp jaws, insert ply packing or a continuous batten between the cramp heads and door edge. To stop the bar of the cramp scuffing the face of the door insert a thin piece of plywood along each stile.
- 2 Before leaving the glue to set, check that the door is square, by measuring across the diagonals and checking that it has no twist, using winding strips to sight along it.



59

Finishing

If the doors are to be given a clear finish, it is very important not to leave traces of glue on the surface. When gluing the joints together try to judge the amount of glue used so that it just forms a thin line on the surface that can be cut off later. If the glue runs onto the surface thoroughly wipe this away with a damp cloth making sure that the glue is completely removed from the grain as well as the surface. If this is not done properly any stain or polish subsequently applied may highlight the area in the form of a white stain.

HINGES



The size and type of hinge chosen will depend on the size and weight of the door itself. With flap hinges the thickness of the door stile in relation to the flap width will dictate the hinge size used. Economy lay-on hinges are only suitable for lightweight doors up to 450mm wide. Concealed hinges will support larger and heavier doors and are fully adjustable once fitted.

Flap hinges

Traditional solid drawn or plated flap hinges can be used where the door is set flush into the cabinet carcass. Flap hinges are set into recesses cut in the cabinet side and door stile. These recesses can again be cut with the router, using a simple template and guide bush.

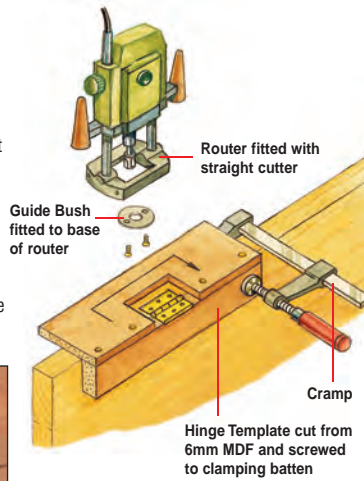

Lay-on hinges

Lay-on hinges are commonly used for economy cabinet construction, being simply screwed to the inside face of the cabinet or frame and the stile edge.

60

EDGE MOULDING



Edge moulding using a side fence.



Where cabinet doors are to be fitted to the face of the carcass or frame, a further attractive effect can be achieved by routing a chamfer or decorative moulding around the outer edges.

Choose a moulding of similar style to the profile moulding cutter and/or raised panel cutter and of similar size.

Edge moulding can be quickly carried out with cutters guided by the side fence or using ball bearing guided cutters.

When edge routing doors with raised panels that are higher than the frame face, it is advisable to fit a packing piece to the underside of the router to support it on the frame face rather than the panel face. When using the side fence, it is advisable to extend the fence facings (cheeks), in order to prevent the cutter from turning in as it starts and finishes the cut at each end of the stile or rail.

62

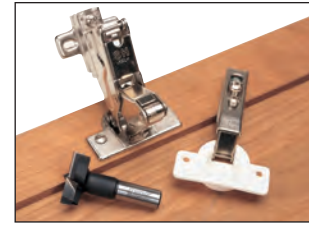

Concealed hinges

The type of hinge used on doors depends on the construction of the cabinet, its location and use. When used on kitchen and other fitted cabinets, where the door covers part or all of the cabinet frame, it is common practice to use concealed hinges.

These are generally designed to open to an angle of 100 degrees, although special lay back examples allow the doors to open clear of the cabinet sides to allow

unrestricted access. These hinges have a circular boss that is sunk into the door panel and are available in either plain or sprung versions. The latter eliminates the need for a separate catch or lock. They are available with various boss diameters, although 35mm is the most common.



Fall Flap hinges

Fall flap hinges (as used on desks and light duty work flaps) are fitted in a

similar way to concealed hinges, using a template to position the cutter over the face edge of the door and carcass.

Machining the holes



Our new range of machine bits are for use in portable plunge routers. These specially designed machine bits have a new form of scriber to allow use at high speeds, Max. 20,000 RPM. For accurate repetitive routing, a template and guide bush fitted to the router base should be used. Ref. 105 group.

61

Trend Machinery & Cutting Tools Ltd.
 Odhams Trading Estate St Albans Road
 Watford WD24 7TR England
 Tel: 0044(0)1923 249911
 technical@trendm.co.uk
 www.trend-uk.com



BOOK/PD v2.1