

TONGUE & GROOVE SET

A one-piece bearing guided set. Parts are interchangeable on the arbor to alter the set-up.

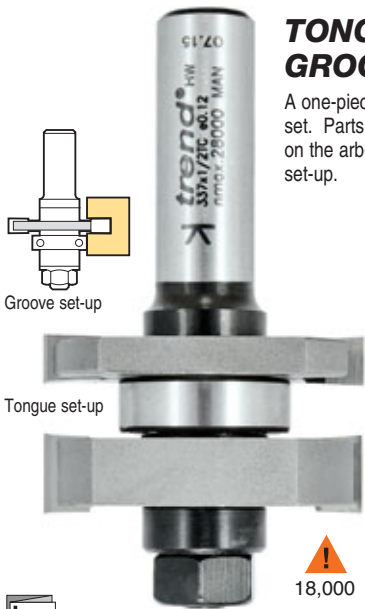

Timber thickness
Min. 15.0mm
Max. 22.0mm

18,000

INST Instructions supplied

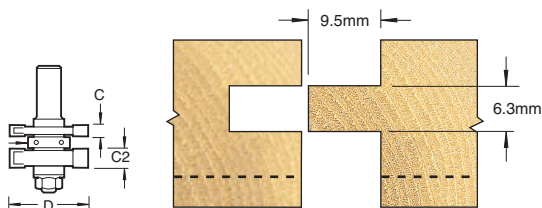

C mm	C2 mm	D mm	B mm	Product Ref.	Shank Diameter 1/2"
6.35	10.0	41.0	22.0	337	£84.84

'T' SLOTTERS & SLAT WALL CUTTER

A range of heavy duty 'T' slot cutters for clamping and hanging applications.

▲ Relief cut required on Refs. 35/3, 35/4 & 35/5.

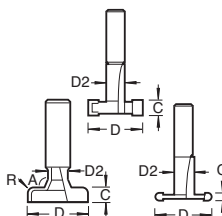
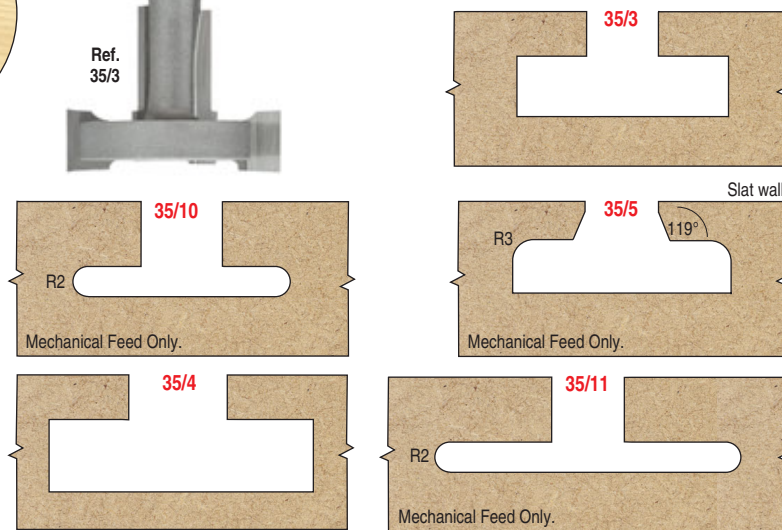
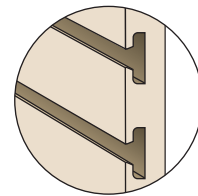

A Deg.	R mm	D mm	D2 mm	C mm	Product Ref.	Shank Diameter 3/8"	Shank Diameter 1/2"
-	-	28.0	9.5	8.0	35/3	£52.99	-
-	2.0	28.0	11.2	4.0	35/10	£52.99	-
119°	3.0	30.0	10.5	7.0	35/5	-	£63.60
-	-	35.0	12.7	9.5	35/4	-	£63.60
-	2.0	40.8	9.7	4.0	35/11	£52.99	-

KEYHOLE

A keyhole recess for picture hanging flush to the wall.
Ref. 35/0 - No.8 & No.10 screw heads.
Ref. 35/01 - No.10 & No.12 screw heads.
Not suitable for grooving applications.



Ref. 35/0

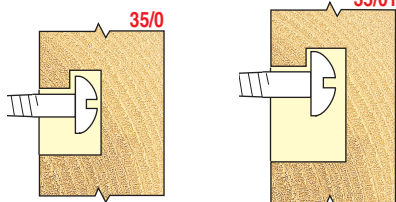

INST Instructions supplied

D2 mm	D mm	C mm	D2 mm	S mm	Product Ref.	Shank Dia. 1/4"
9.5	4.5	4.5	5.5	5.5	35/0	£36.14
12.7	4.9	8.0	4.6	4.6	35/01	£39.70

UNDERCUT CUTTER

Produces an undercut on relief lettering to create an aesthetic appearance, as well as for edge grooving.



Ref. 30/6

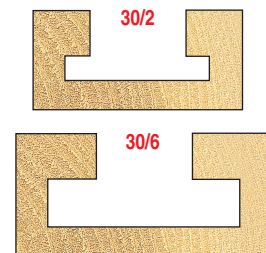

D mm	C mm	E mm	B mm	Product Ref.	Shank Dia. 1/4"
19.1	3.2	3.2	12.7	30/2	£42.49
25.4	6.3	6.35	12.7	30/6	£46.58

'T' SLOTTED

Slots for concealing electric cables etc. A 6mm slot must be cut first to allow for the cutter neck.

▲ Care must be taken to avoid breakage



Ref. 35/1

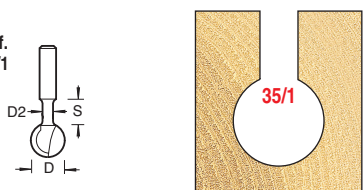

D mm	C mm	D2 mm	S mm	Product Ref.	Shank Dia. 1/4"
12.0	-	4.0	10.0	35/1	£52.99

BALL GROOVER

Ideal for hiding pipes and cables. Part of curve can be used for producing decorative edges.

▲ An initial slot with a straight cutter is required before using the ball groovers.



Ref. 35/20

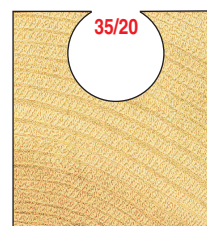

D mm	D2 mm	Product Ref.	Shank Dia. 1/2"
12.7	6.5	35/20	£50.00