

SLOTTING & GROOVING



PROFESSIONAL ROUTER CUTTERS

BEARING GUIDED BISCUIT JOINTER SET

For biscuit jointing of timber, man-made fibre and particle board with the router. The set includes three sizes of bearing which set the correct depth of cut for the three sizes of biscuit available.

A slightly longer cut than the length of the biscuit is required, to allow some lateral play for easy alignment during assembly. A water based glue (PVA) is used with the biscuits which will expand as the moisture is absorbed. Boards are simply clamped together until glue is cured.

For larger boards, biscuits can be doubled up by making two passes.



Profiles showing cross section of biscuit joints.

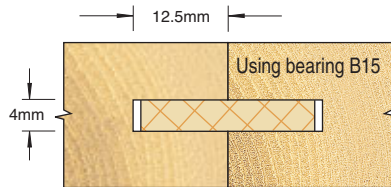
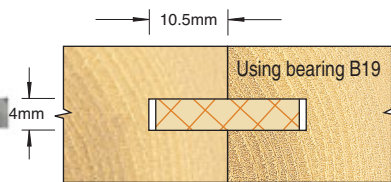
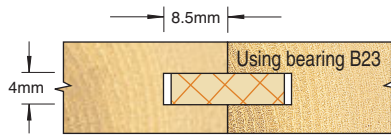

Biscuit dimensions shown below. All sizes shown are nominal.

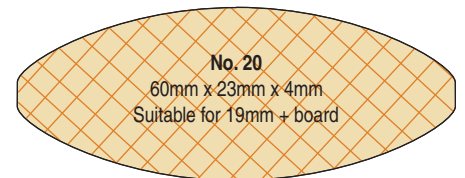
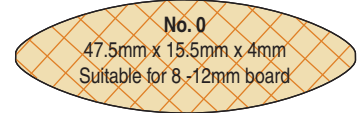

WOODEN BISCUITS

See page 196 for a variety of sizes available.



For certified biscuits see our website.



includes three bearings

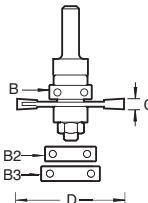

Instructions supplied

D mm	C mm	B mm	B2 mm	B3 mm	Product Ref.	Shank Diameter 1/4"	8mm	1/2"
40.0	4.0	15.0	19.0	23.0	342	£65.36	£65.36	£65.36

BEARING GUIDED MATCHLINING SET

A complete cutter set for producing matchlining. Jointing parts are interchanged on the arbor to change the mode of the cutter. A 6.0mm tongue is obtained. Includes two bearings and two groovers.

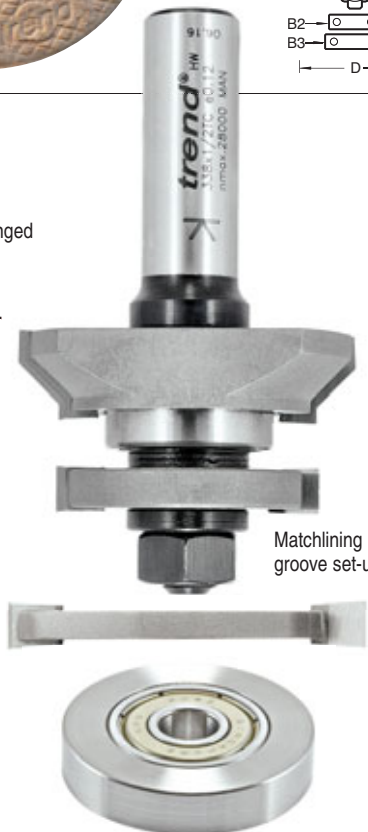
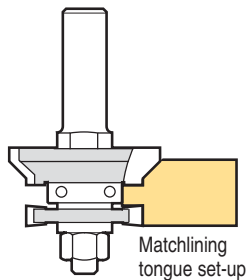

Timber thickness
Min. 15.0mm
Max. 19.0mm

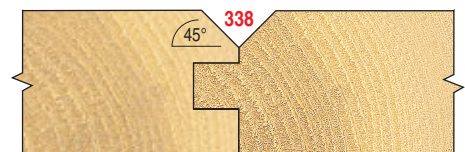
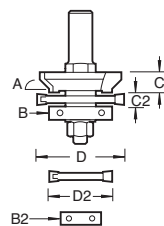

Instructions supplied

18,000

A Deg.	D mm	D2 mm	C mm	C2 mm	B mm	B2 mm	Product Ref.	Shank Dia. 1/2"
45°	47.0	-	11.0	6.0	34.0	22.0	338	£127.26