

BEARING GUIDED COMBI TRIMMER

- Self-guided combination trimmer.
- A 90° trim is obtained by engaging the bottom half.
- A 45° trim is obtained by lowering the cutter.
- A fine height adjuster is recommended when using this cutter.
- A larger 20mm bearing will spread the wear to the cutting edges when 45° trimming.

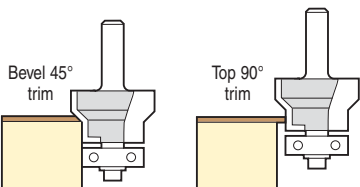
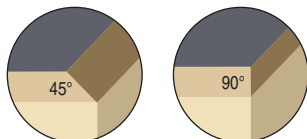

A Deg.	A2 Deg.	D mm	C mm	C2 mm	C3 mm	B mm	Prod. Ref.	Shank Dia. 1/4"
90°	45°	25.0	6.0	5.0	6.0	18.0	46/06	£52.80

REPLACEMENT BEARING

Bearing 18.2mmØ **B182** £12.17

ALTERNATIVE BEARING

Bearing 20.0mmØ to spread wear **B20** £11.06

BEARING GUIDED BEVEL TRIMMER

- Five self-guided trimmers.
- Cut a wider edge line, at angles between 30° & 80°.
- Two flutes for clean finish.
- A larger 19mm diameter bearing will spread the wear of the cutting edges for cutter Refs. 46/3 & 46/6A - 46/6C.

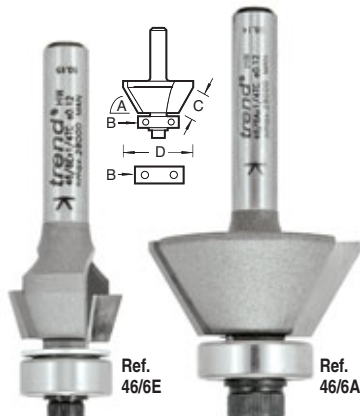
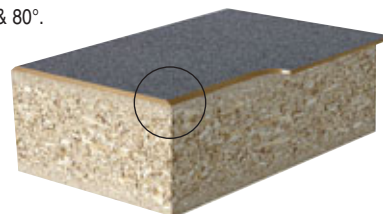

A Deg.	D mm	C mm	B mm	Prod. Ref.	Shank Dia. 1/4"
80°	20.5	14.0	16.0	46/3	£47.27
75°	15.9	6.3	12.7	46/6E	£24.47
60°	29.0	13.0	16.0	46/6A	£48.04
30°	28.0	7.0	16.0	46/6C	£45.25

REPLACEMENT BEARINGS

For 46/3, 46/6A-6C 16.0mmØ **B16** £4.64

For 46/6E-F 12.7mmØ **B127A** £5.18

ALTERNATIVE BEARING

For 46/3, 46/6A-6C 19.0mmØ **B19** £5.18

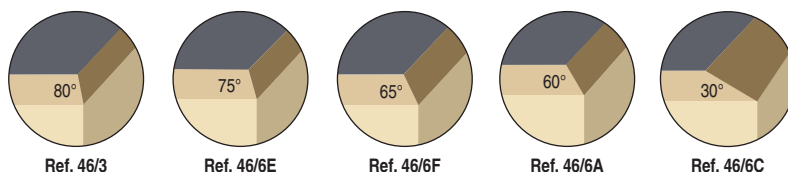

BEARING GUIDED CHAMFER TRIMMER

- Cut a wider edge line, at 45° angle.
- Two flutes for clean finish.

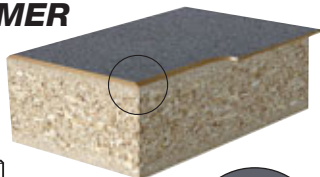

A Deg.	D mm	C mm	B mm	Prod. Ref.	Shank Dia. 1/4"
45°	28.5	8.5	16.0	46/6B	£48.71

REPLACEMENT BEARING

Bearing 16.0mmØ **B16** £4.64

ALTERNATIVE BEARING

Bearing 19.0mmØ **B19** £5.18

BEARING GUIDED DOUBLE TRIM

- For trimming top and bottom surfaces simultaneously with bearing following the core.
- Two fluted.
- Increased productivity.

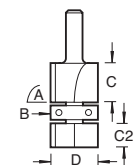

A Deg.	D mm	C mm	C2 mm	Product Ref.	Shank Dia. 1/4"
90°	18.0	15.0	9.0	46/7	£66.69

REPLACEMENT BEARING

Bearing 18.0mmØ **B18** £12.17

90° TRIMMER

- Ref. 37/1 has three flutes and bevelled corners to prevent scoring. Ideal for flush trimming of hardwood or plastic edge strip to obtain fine finish. Use with a side-fence.
- Ref. 47/2 is for trimming the lipping of plastic overlay and for rebating and machining wood, Duralium and plastics.



Trimming hardwood lipping with Ref. 37/1.



90° top trim & lip trim with Ref. 47/2.

A Deg.	D mm	C mm	Product Ref.	Shank Dia. 1/4"
90°	25.0	12.0	37/1	£58.35
90°	18.0	12.0	47/2	£43.03

