

## BEARING GUIDED INFINITELY VARIABLE 'QUAD' GROOVER SET

This versatile 1/2" shank groover set offers grooving widths of 3.2mm, 4.0mm, 4.8mm and 6.3mm. It is also infinitely variable from 6.6mm to 18mm in 0.1mm increments.

A jointing facility using the bearing is also possible.

Set comprises of four 2 wing groovers with 7.94mm (5/16") bore and an arbor which may be used singly or together to produce a wide range of groove widths. One ball bearing supplied as standard.

This set can also be used to tongue and groove 9mm to 22mm board.

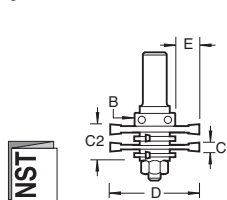

Instructions supplied

18,000

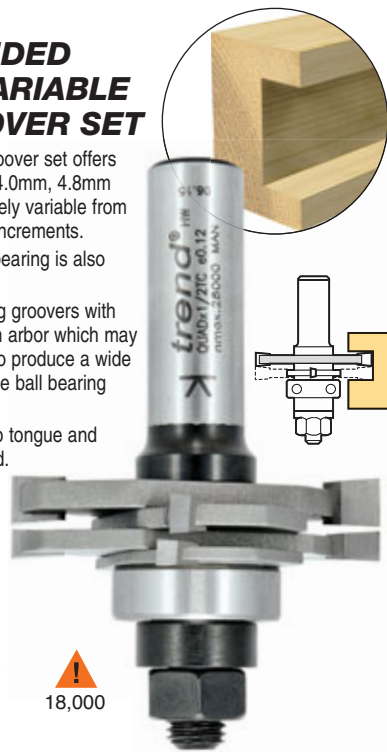

Description	E mm	C2 mm	D mm	B mm	Product Ref.	Shank Dia. 1/2"
Quad Groover Set	12.8	3.2 to 18.0	47.6	22.0	<b>QUAD</b>	£95.43

### COMPRISES

	E mm	C mm	D mm	B mm	Product Ref.	Price
Groover A	12.8	3.2	47.6	-	<b>SP-QUAD/18</b>	£28.58
Groover B	12.8	4.0	47.6	-	<b>SP-QUAD/532</b>	£28.58
Groover C	12.8	4.8	47.6	-	<b>SP-QUAD/316</b>	£28.58
Groover D	12.8	6.3	47.6	-	<b>SP-QUAD/14</b>	£28.58
Standard bearing	12.8	7.0	-	22.0	<b>BB22</b>	£11.11
Arbor	-	-	-	-	<b>33/30</b>	£9.80

### ACCESSORIES (not included in set)

	E mm	C mm	D mm	B mm	Product Ref.	Price
Groover	12.8	1.6	47.6	-	<b>SP-QUAD/116</b>	£16.23 +
Groover	12.8	2.0	47.6	-	<b>SP-QUAD/564</b>	£16.23 +
Bearing 19.0mmØ	14.3	6.0	-	19.0	<b>BB19</b>	£11.06
Bearing 24.0mmØ	11.8	8.0	-	24.0	<b>BB24</b>	£10.85
Bearing 25.0mmØ	11.3	8.0	-	25.0	<b>BB25</b>	£14.96
Bearing 26.0mmØ	10.8	6.0	-	26.0	<b>BB26</b>	£14.96
Bearing 28.0mmØ	9.8	8.9	-	28.0	<b>BB28</b>	£14.96
Bearing 29.0mmØ	9.2	8.0	-	29.0	<b>BB29</b>	£14.96
Bearing 30.0mmØ	8.8	8.0	-	30.0	<b>BB30</b>	£14.96
Bearing 34.0mmØ	6.8	8.0	-	34.0	<b>BB34</b>	£14.96



18,000

## BEARING GUIDED VARIABLE KERF GROOVER

To adjust the groove width, these tools can be re-assembled with the supplied shims and spacers inserted between the groovers, giving a 0.1mm increment in thickness.

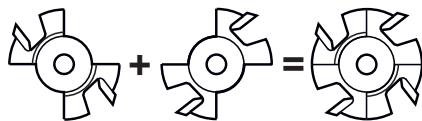

C mm	E mm	D mm	B mm	Product Ref.	Shank Dia. 1/2"
3.0 to 5.0	11.0	50.0	28.0	<b>27/35</b>	£63.60
5.0 to 9.0	11.0	50.0	28.0	<b>27/59</b>	£68.91

## SHIMS & SPACER SET

### SHIM SETS

Set of twelve shims for fine adjustment of slotters and groovers on arbors. Each set comprises two shims of each thickness.

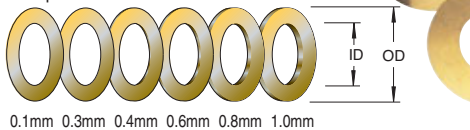

0.1mm 0.3mm 0.4mm 0.6mm 0.8mm 1.0mm

### SHIM PACKS

Spare shim packs for adjusting profile scribe sets. Supplied in packs of 10, either 0.05mm or 0.1mm thick.

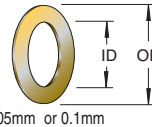

0.05mm or 0.1mm

### SPACER SET Ref. SPACER/63

A set of six spacers. Comprises three of each size.

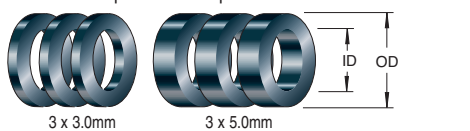

3 x 3.0mm 3 x 5.0mm

### SPACER SET Ref. SPACER/8

A set of thirteen 8mm spacers & shims. Comprises two spacer/shims of each thickness & one extra 0.05mm shim.

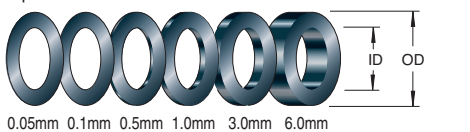

0.05mm 0.1mm 0.5mm 1.0mm 3.0mm 6.0mm

### SPACER SET Ref. SPACER/12

A set of six 12mm bore spacers.

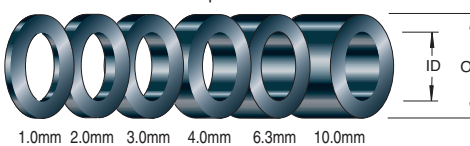

1.0mm 2.0mm 3.0mm 4.0mm 6.3mm 10.0mm



## SPECIALIST GROOVER

Two wing groovers have 6.35mm (1/4") bore. For use with Ref. 33/60 arbor.

Allows decorative cuts in panels and frames to disguise glue lines & for fluting effects.

With arbor Ref. 33/60X1/4, the max. distance from the edge is approx. 25mm. With arbor Ref. 33/60X1/2, the max. distance from the edge is approx. 35mm.



Ref. 34/200



Ref. 34/220

A Deg.	R mm	C mm	D mm	B mm	Product Ref.	Bore size 1/4"
45°	-	6.0	36.0	6.35	<b>34/200</b>	£36.75 +
-	3.0	6.0	36.0	6.35	<b>34/220</b>	£47.32

### ARBOR & BEARINGS

Arbor with 1/4", 8mm or 1/2" shank	<b>33/60</b>	£17.08
Bearing 30.0mmØ for 3.0mm depth	<b>B300</b>	£11.06
Bearing 29.0mmØ for 3.5mm depth	<b>B290</b>	£10.48
Bearing 28.0mmØ for 4.0mm depth	<b>B280</b>	£10.48
Bearing 26.0mmØ for 5.0mm depth	<b>B260</b>	£10.48

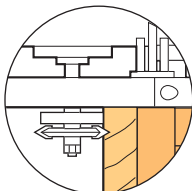

! For stationary machines at max. recommended speeds as indicated.

+ While stocks last