

MILLING TOOLS TCT

TUNGSTEN
CARBIDE
TIPPED

LARGE TENON

- Four fluted for a clean finish.
- Two down-shear blades for the shoulder and two up-shear for the face of the tenon.
- For abrasive materials, timber and manmade board.
- Improved finish on interlocking grain.

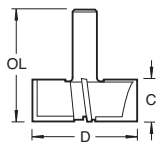

D mm	C mm	OL mm	Product Ref.	Shank Dia 1/2"
50.0	20.0	68.0	37/12	£91.73



SIX WING TRIMMER

- For trimming and face milling of timber.
- Ideal for face milling of solid surface material, including Corian® and similar luxury solid surface material.

Face milling to provide a flat surface for waste fitting.

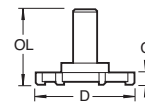
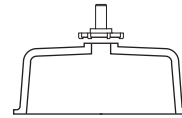

D mm	C mm	OL mm	Product Ref.	Shank Dia. 1/2"
52.3	6.5	83.0	90/22	£72.24

CARAVAN INDUSTRY TOOLING

GUIDED PIERCE & TRIM

- Combination pierce and trim cutters.
- Pierce and cut out apertures in laminate worktops.
- Using nose of the cutter as a guide.
- Ref. S47/4 is made from Solid Carbide for long life.
- Refs. 47/50, 47/50S and 47/42 will trim bottom and top laminate simultaneously.
- Refs. 47/50S is specially designed for the caravan building industry, used for cutting apertures in windows, doors and the floor pan.
- Ref. 59/1 is a single fluted spiral, specifically suited for aluminium panels in caravan manufacture.

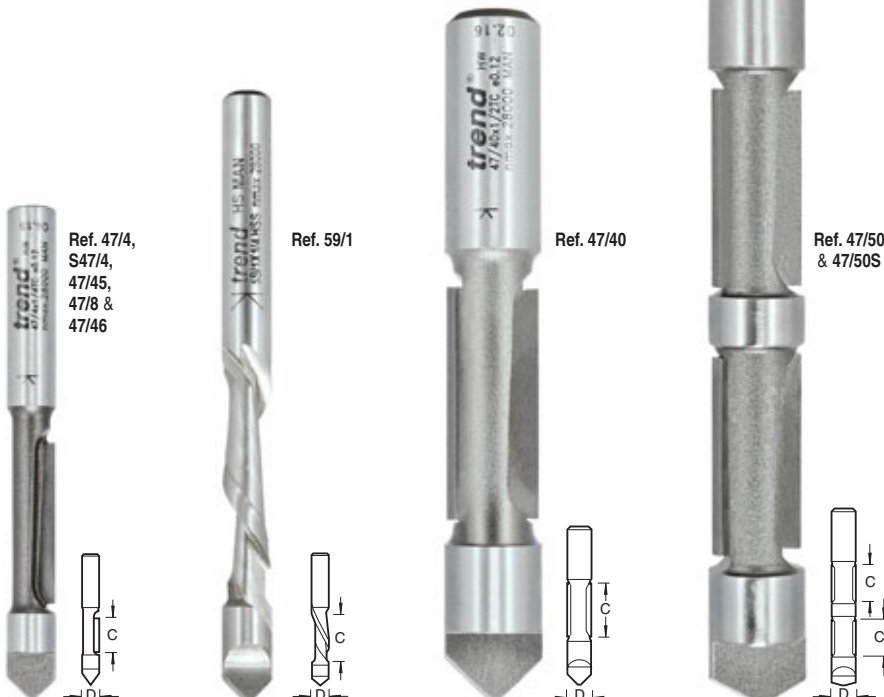
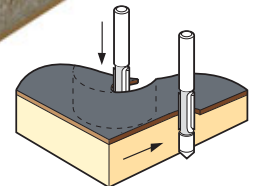
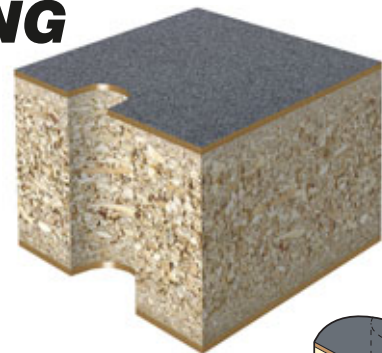
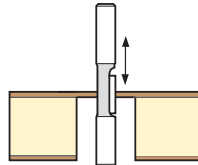

TCT SINGLE FLUTE

D mm	C mm	Product Ref.	Shank Diameter 1/4" 3/8"
6.3	18.0	47/4	£23.69 -
9.5	25.0	47/45	£29.70 +

TCT TWO FLUTE

D mm	C mm	Product Ref.	Shank Diameter 1/2"
12.7	30.0	47/40	£47.27

TCT DOUBLE TWO FLUTE

D mm	C mm	C2 mm	Product Ref.	Shank Diameter 1/2"
12.7	22.5	22.5	47/50S	£59.14
12.7	24.0	24.0	47/50	£59.14

STC SINGLE FLUTE

D mm	C mm	Product Ref.	Shank Diameter 1/4"
6.3	22.0	S47/4	£33.34

HSS SINGLE FLUTE SPIRAL

D mm	C mm	Product Ref.	Shank Diameter 1/4"
6.3	19.1	59/1	£35.48

+ While stocks last

! For stationary machines at max. recommended speeds as indicated.