



AIRSHIELD PRO



RESPIRATOR APPROVED TO EN12941:1999
VISOR APPROVED TO EN166:2002

trend[®]
routing technology



Please read these instructions before use.

Dear Customer

Thank you for purchasing this Trend product, we hope you enjoy many years of creative and productive use.

Please remember to return your guarantee card within 28 days of purchase.

CONTENTS

INTRODUCTION _____	1
SUITABILITY FOR USE _____	2
APPROVALS _____	3
TECHNICAL DATA _____	3
SAFETY _____	4 - 5
ELECTRICAL SAFETY _____	6 - 7
ADDITIONAL PRECAUTIONS _____	8
ITEMS ENCLOSED _____	8
DESCRIPTION OF PARTS _____	9
ASSEMBLY, ADJUSTMENT & OPERATION	
- Battery Pack Charging and Installation _____	10
- Visual Inspection _____	11
- Functional Test _____	11
- Low Battery Warning _____	11
- Fitting Procedure _____	12
- Removing Respirator _____	12
- Ear Defender Clips _____	12
ACCESSORIES _____	13
MAINTENANCE & CARE _____	13
- Routine Checks _____	14
- Storage _____	14
- Transportation _____	14
REPLACEMENT SPARE PARTS _____	15
- Battery Pack _____	15
- Air Filter _____	16
- Face Seal _____	16
- Headband _____	17
- Visor _____	17
- Visor Overlay _____	17
- Fan Motor Unit _____	18
- Electronics Unit/Switch Housing _____	18
ENVIRONMENTAL PROTECTION _____	19
GUARANTEE _____	19
SPARE PARTS _____	20
- Spare Parts List _____	20
- Spare Parts Diagram _____	IB

INTRODUCTION

The Airshield Pro is a lightweight Powered Respirator intended for protection against all solid dusts. This is combined with full eye and face protection from impact and chemical liquid splash.

The Airshield Pro is powered by a rechargeable battery pack held inside the respirator. Air is filtered through the respirator to provide a constant flow of clean air over the face. A face seal ensures that positive pressure is maintained within the respirator.

The Airshield Pro has an adjustable headband and concussion cradle, ensuring a comfortable fit for most head sizes.

Read this manual before using the Airshield Pro. It must be fitted and used in accordance with this manual to obtain the design performance. Use as part of your maintenance programme.

The following symbols are used throughout this manual:



Denotes risk of personal injury, loss of life or damage to the tool in case of non-observance of the instructions in this manual.



Denotes risk of electric shock.



If you require further safety advice, technical information or spare parts, please call Trend Technical Support or visit www.trend-uk.com

SUITABILITY FOR USE

This respirator must be used strictly in accordance with these instructions. Do not use this respirator for protection against unknown atmospheric contaminants or when concentrations of contaminants are unknown or immediately dangerous to life or health, or in atmospheres likely to be deficient in oxygen.

Only use this respirator with the parts and accessories listed in these instructions.

The respirator is only for use by trained, competent personnel. In the power-off state little or no respiratory protection is to be expected, and this is considered to be an abnormal situation.

In the power-off state there will be a rapid build up of carbon dioxide and depletion of oxygen may occur.

Without the face seal fitted no respiratory protection is to be expected. At very high work rates and peak inhalation the pressure flow in the device may become negative.

Ophthalmic spectacles may transmit impacts from high-speed particles, thus creating a hazard to the wearer.

Leave the contaminated area immediately if any of the following conditions apply:

- The buzzer sounds.
- Any part of the respirator becomes damaged.
- Airflow into the respirator decreases or stops.
- Breathing becomes difficult.
- Dizziness or other physical distress or irritation occurs.
- The user tastes or smells contaminants.

Never modify or alter this product, except as directed in the service tasks contained in these instructions.

Some fabric parts of the respirator which may come into contact with the wearer's skin could cause allergic reactions to susceptible individuals.

UK:	Suitable for use under COSHH, CAW, CLAW and IRR.
Head Protection:	This is NOT an industrial safety helmet.

Transportation

For transportation purposes use the carry bag provided and protect the unit from physical or chemical damage.



Please read the operating instructions carefully and keep them together with the respirator.



Before use fully charge the battery for 24 hours.



Not to be used if the contaminate is potentially explosive or highly flammable.

APPROVALS

EUROPE

This product has been shown to meet the requirements of Article 10 of the European Directive 89/686/EEC and is manufactured in accordance with Article 11B quality monitoring system, and thus is CE marked.

Article 10 and 11B assessments conducted by:

British Standards Institution
Maylands Avenue
Hemel Hempstead
Herts
HP2 4SQ
UK.

(Notified Body Number: 0086)

Product assessed against the requirements of the following standards:

Respiratory Protection:

BS EN 12941:1999, respiratory devices, powered filtering devices class TH2P-S. For use against solid particulates only.

Eye Protection:

BS EN 166:2002, personal eye protection.
Class 1B3.
Optical class 1; high-speed particles - medium energy impact, B; liquid droplets and splashes, 3.

AUSTRALIA / NEW ZEALAND

Ref. AIR/PRO/ANZ

Respiratory Protection:

AS/NZS 1716: 2003, respiratory protective devices PAPR-P2 for use against solid and water based particulates only.

Lic: SMK1607

Eye Protection:

AS/NZS 1337: 1992, Eye Protectors for Industrial Applications.

High Impact Resistance OVC

O - outdoor use, untinted

V - high impact

C - splash proof

Lic: SMK1633

When servicing or maintaining, reference AS/NZS 1715 Use and Maintenance or respiratory devices.

TECHNICAL DATA

Type:	Respirator, powered particle filtering device.
Voltage:	12V
Head size	54 to 61cm
Protection factor	Assigned (APF) 20
Motor sound level	70db
Weight:	1.0kg nominal
Temperature range:	Charging +5°C to +40°C Use -5°C to +40°C Storage +5°C to +40°C
Airflow:	Initial 210 l/min (clean filter, fully charged battery) Minimum 150 l/min
Humidity	0-90% storage and use (Store out of direct sunlight)
Pressure	Storage 800 to 1300 mbar Use 800 to 1300 mbar

Battery

Type:	Ni-MH
Voltage	3 Cell, nominal 3.6V
Capacity	3.5Ah
Life	8 hours (fully charged battery pack fitted)

Charging method/rate	Mains Charger 14 hours from fully discharged
----------------------	---

Weight:	0.19kg
---------	--------

Charger

Mains voltage:	230V 
Consumption	4W nominal
No load output	12VDC
Nominal output	4.2V 300mA
IP20	Indoor use only EN 60335-1, 60335-2-29
Weight	0.2kg

SAFETY

WARNING:



Observe the safety regulations in the instruction manual of the power tool to be used. Please read the following instructions carefully. Failure to do so could lead to serious injury. When using electric tools, basic safety precautions, including the following should always be followed to reduce the risk of fire, electric shock and personal injury. Also observe any applicable additional safety rules. Read the following safety instructions before attempting to operate this product.

PLEASE KEEP THESE INSTRUCTIONS IN A SAFE PLACE.

The attention of UK users is drawn to The Provision and Use of Work Equipment Regulations 1998, and any subsequent amendments.

Users should also read the HSE/HSC Safe Use of Woodworking Machinery Approved Code of Practice and Guidance Document and any amendments.

Users must be competent with woodworking equipment before using our products.

IMPORTANT NOTE:

Residual Risk. Although the safety instructions and operating manuals for our tools contain extensive instructions on safe working with power tools, every power tool involves a certain residual risk which cannot be completely excluded by safety mechanisms. Power tools must therefore always be operated with caution!

General

1. Disconnect power tool and attachment from power supply when not in use, before servicing, when making adjustments and when changing accessories such as cutters. Ensure switch is in "off" position. Always ensure cutter has stopped rotating.
2. Always mount the power tool, accessory or attachment in conformity with the instructions. Only use attachment and accessories specified in the power tool manual. The tool or attachment should not be modified or used for any application other than that for which it was designed. Do not force tool.
3. Keep children and visitors away. Do not let children or visitors touch the tool, accessory or attachment. Keep children and visitors away from work area. Make the workshop child proof with padlock and master switch.
4. Dress properly. Do not wear loose clothing or jewellery, they can be caught in moving parts. Rubber gloves and non-skid footwear is recommended when working outdoors. Wear protective hair covering to contain long hair.

5. Consider working environment. Do not use the product in the rain or in a damp environment. Keep work area well lit. Do not use power tools near gasoline or flammable liquids. Keep workshop at a comfortable temperature so your hands are not cold. Connect machines that are used in the open via a residual current device (RCD) with an actuation current of 30 mA maximum. Use only extension cables that are approved for outdoor use.
6. The accessory or attachment must be kept level and stable at all times.
7. Keep work area clean. Cluttered workshops and benches can cause injuries. Ensure there is sufficient room to work safely.
8. Secure idle tools. When not in use, tools should be stored in a dry and high or locked up place, out of reach of children.
9. For best control and safety use both hands on the power tool and attachment. Keep both hands away from cutting area. Always wait for the spindle and cutter to stop rotating before making any adjustments.
10. Always keep guards in place and in good working order.
11. Remove any nails, staples and other metal parts from the workpiece.
12. Maintain tools and cutters with care. Keep cutters sharp and clean for better and safer performance. Do not use damaged cutters. Follow instructions for lubricating and changing accessories. Keep handles dry, clean and free from oil and grease.
13. Maintain accessories. Do not use damaged accessories. Only use accessories recommended by the manufacturer.
14. Check damaged parts. Before operation inspect the attachment, the power tool, the cable, extension cable and the plug carefully for signs of damage. Check for alignment of moving parts, binding, breakage, mounting and any other conditions that may affect its operation. Have any damage repaired by an Authorised Service Agent before using the tool or accessory. Protect tools from impact and shock.
15. Do not use tool if switch does not turn it on or off. Have defective switches replaced by an Authorised Service Agent.
16. Don't over reach. Keep proper footing and balance at all times. Do not use awkward or uncomfortable hand positions.
17. Don't abuse the cable. Never carry power tool or accessory by cord or pull it to disconnect from the socket.

Keep cord from heat, oil and sharp edges. Always trail the power cord away from the work area.

18. Connect dust extraction equipment. If devices are provided for the connection of dust extraction and collection facilities, ensure these are connected and properly used.
19. Check all fixing and fastening nuts, bolts and screws on power tool, attachment and cutting tools before use to ensure they are tight and secure. Periodically check when machining over long periods.
20. Stay alert. Watch what you are doing. Use common sense. Do not operate tools when you are tired, under the influence of drugs or alcohol.
21. Personal Protective Equipment (PPE) for eye, ear and respiratory protection must be worn. All PPE must meet current UK and EU legislation.
22. Do not leave tools running unattended. Do not leave tool until it comes to a complete stop.
23. Always clamp workpiece being machined securely.
24. Only use cutting tools for woodworking that meet EN847-1/2 safety standards, and any subsequent amendments.
25. Vibration levels. Hand held power tools produce different vibration levels. You should always refer to the specifications and relevant Health & Safety Guide.

Routing Safety

1. Read and understand instructions supplied with power tool, attachment and cutter.
2. Keep hands, hair and clothing clear of the cutter.
3. Remove adjusting keys and spanners. Check to see that keys and adjusting spanners are removed from the router tool, cutter and attachment before turning router on. Make sure cutter can rotate freely.
4. Noise. Take appropriate measures for the protection of hearing if the sound pressure of 85dB(A) is exceeded. Routing sound pressure may exceed 85dB(A), so ear protection must be worn.
5. Eye protection. Always wear eye protection in the form of safety goggles, spectacles or visors to protect the eyes.
6. Respiratory protection. Always wear a face or dust mask, or powered respirator. Dust masks/filters should be changed regularly.
7. Do not switch router on with the cutter touching the workpiece. At the end of the cut, release the router plunge and allow spindle to stop rotating. Never use the spindle lock as a brake

8. The direction of routing must always be opposite to the cutter's direction of rotation. Do not back-cut or climb-cut.
9. Check before cutting that there are no obstructions in the path of the router. Ensure there are no obstacles beneath workpiece when cutting full thickness, and that a sacrificial work surface is used.
10. Hold power tool by insulated gripping surfaces, because the cutter may contact its own cord. Cutting the "live" wire may make exposed metal parts of the powertool "live" and shock the operator.
11. Use clamps or another practical way to secure and support the workpiece to a stable platform. Holding the work by your hand or against the body leaves it unstable and may lead to loss of control.
9. Cutter shanks should be inserted into the collet all the way to the line indicated on the shank. This ensures that at least $\frac{3}{4}$ of the shank length is held in the collet. Ensure clamping surfaces are cleaned to remove dirt, grease, oil and water.
10. Observe the correct assembly and fitting instructions in the router instruction manual for fitting the collet, nut and cutter.
11. Tool and tool bodies shall be clamped in such a way that they will not become loose during operation. Care shall be taken when mounting cutting tools to ensure that the clamping is by the shank of the cutting tool and that the cutting edges are not in contact with each other or with the clamping elements.
12. It is advisable to periodically check the collet and collet nut. A damaged, worn or distorted collet and nut can cause vibration and shank damage. Do not over-tighten the collet nut
13. Do not take deep cuts in one pass; take several shallow or light passes to reduce the side load applied to the cutter and router. Too deep a cut in one pass can stall the router.
14. In case of excessive vibrations whilst using the router stop immediately and have the eccentricity of the router, router cutter and clamping system checked by competent personnel
15. All fastening screws and nuts should be tightened using the appropriate spanner or key and to the torque value provided by the manufacturer.
16. Extension of the spanner or tightening using hammer blows shall not be permitted.
17. Clamping screws shall be tightened according to instructions provided by the manufacture. Where instructions are not provided, clamping screws shall be tightened in sequence from the centre outwards.
18. Do not touch the cutter immediately after operation; it may be extremely hot and could burn your skin.

Using Routers In A Fixed Position

1. Attention should be made to the HSE's Safe Use of Vertical Spindle Moulding Machines Information Sheet No.18 and any revisions.
2. After work, release the router plunge to protect the cutter.
3. Always use a push-stick or push-block when making any cut less than 300mm in length or when feeding the last 300mm of the cut.
4. The opening around the cutter should be reduced to a minimum using suitably sized insert rings in the table and closing the back fence cheeks or

fitting a false fence on the back fence.

5. Whenever possible use a work holding device or jig to secure component being machined. Ensure any attachment is securely fitted to the workbench, with table surface at approximately hip height.
6. Use a No-Volt Release Switch. Ensure it is fixed securely, easily accessible and used correctly.
7. In router table (inverted) mode, stand to the front right of the table. The cutter will rotate anti-clockwise when viewed from top so the feed direction is from the right (against the rotation of the cutter). In overhead mode, stand to the front left of the machine table and the feed direction is from the left.
8. Do not reach underneath table or put your hands or fingers at any time in the cutting path while tool is connected to a power supply.
9. Never thickness timber between the back of the cutter and the backfence.

Useful Advice When Routing

1. Judge your feed rate by the sound of the motor. Feed the router at a constant feed rate. Too slow a feed rate will result in burning.
2. Trial cuts should be made on waste material before starting any project.
3. When using some attachments e.g. a router table or dovetail jig, a fine height adjuster is recommended.
4. When using a template guide bush, ensure there is sufficient clearance between cutter tip and inside edge of bush and that it cannot come into contact with collet and nut. Ensure cutter and guide bush are concentric.

Router Cutter Repair/Maintenance

1. Repair of tools is only allowed in accordance with the manufacturers instructions.
2. The design of composite (tipped) tools shall not be changed in process of repair. Composite tools shall be repaired by a competent person i.e. a person of training and experience, who has knowledge of the design requirements and understands the levels of safety to be achieved.
3. Repair shall therefore include, e.g. the use of spare parts which are in accordance with the specification of the original parts provided by the manufacturer.
4. Tolerances which ensure correct clamping shall be maintained.
5. Care shall be taken that regrinding of the cutting edge will not cause weakening of the body and the connection of the cutting edge to the body.

ELECTRICAL SAFETY



Power Supply

The charger has been designed for one voltage only. Always check that the power supply corresponds to the voltage on the rating plate. Machines marked for 230 volt can also be operated from a 220 volt supply.



The charger is double insulated.



Never connect to a light socket. Never connect the live (L) or neutral (N) wires to the earth pin marked E or \perp .

Safety Instructions for Battery Charger

Before using charger, read all instructions and cautionary marking on charger, battery pack, and respirator. Only charge your batteries indoors as the charger is designed for indoor use only.



230 volts present at charging terminal. Do not probe with conductive objects. There is a danger of electric shock.



If battery pack case is cracked or damaged, do not insert into charger. There is a danger of electric shock.

- The charger and battery pack is specially designed to work together. DO NOT attempt to charge the battery pack with any other chargers.
- Do not expose charger to rain or snow.
- The charger is not intended for any uses other than charging AIR/PRO rechargeable batteries. Any other uses may result in risk of fire, electric shock or electrocution.

- To reduce risk of damage to the charger, pull by charger body rather than cord when disconnecting charger from power supply.
- Make sure cord is located so that it will not be stepped on, tripped over, or otherwise subjected to damage or stress.
- An extension cord should not be used.
- The charger is ventilated through slots in the housing. Do not place any object on charger that might block the ventilation slots and result in excessive internal heat. Place the charger in a position away from any heat source.
- Do not operate charger with damaged cord or plug - have them replaced immediately.
- Do not operate charger if it has received a sharp blow, been dropped, or otherwise damaged in any way.
- Do not disassemble charger. Incorrect reassembly may result in a risk of electric shock, electrocution or fire.
- To reduce risk of electric shock, unplug charger from outlet before attempting any cleaning. Removing the battery pack will not reduce this risk.
- **NEVER** attempt to connect two chargers together.
- **DO NOT** store or use the tool and battery pack in locations where the temperature may reach or exceed 40.0°C (such as outside sheds or metal buildings in summer).
- The charger is designed to operate on standard household electrical power. Do not attempt to use it on any other voltage!

Safety Instructions for Battery Packs

- The battery pack is not fully charged when first purchased. First read the safety instructions below, then follow charging notes and procedures.
- Do not incinerate the battery pack even if it is severely damaged or is completely worn out. The battery pack can explode in a fire.

■ A small leakage of liquid from the battery pack cells may occur under extreme usage or temperature conditions. This does not indicate a failure. However, if the outer seal is broken and this leakage gets on your skin:

- a. Wash quickly with soap and water.
- b. Neutralise with a mild acid such as lemon juice or vinegar.
- c. If battery liquid gets into your eyes, flush them with clean water for a minimum of 10 minutes and seek immediate medical attention.

■ Never attempt to open the battery pack for any reason. If the plastic housing of the battery pack breaks or cracks, immediately discontinue use and do not recharge it.

■ Do not carry extra battery packs in aprons, pockets, or tool boxes along with metal objects. Battery pack could be short-circuited causing damage to the battery pack and possibly causing severe burns or fire.

■ Charge the battery packs only in a Trend AIR/PRO charger.

■ Do not charge the tool in a damp or wet environment.

■ Longest life and best performance can be obtained if the battery pack is charged when the air temperature is between 18°C and 24°C. DO NOT charge the battery pack in an air temperature below 5°C, or above 40.0°C. This is important and will prevent serious damage to the battery pack.

■ The charger and battery pack may become warm to touch while charging. This is a normal condition, and does not indicate a problem.

■ To prevent overheating, do not cover the charger and do not charge battery packs in direct sunlight or near heat sources.

■ If the battery pack does not charge properly:-

1. Check the main supply socket by plugging in a lamp or other appliance.
2. Move charger and battery pack to a location where the surrounding air temperature is approximately 18°C and 24°C.

3. If charging problems persist, take or send the tool, battery pack and charger to a Trend Service Agent.

■ DO NOT CONTINUE to use if the battery pack does not charge properly.

■ Always unplug the charger from the power supply when there is no battery pack fitted. Unplug charger before attempting to clean.

■ Do not freeze or immerse charger in water or any other liquid.



Do not allow any liquid to get inside charger. Electric shock may result. To facilitate the cooling of the battery pack after use, avoid placing the charger or battery pack in a warm environment such as in a metal shed, or an un-insulated trailer.



Never attempt to open the battery pack for any reason. If the plastic housing of the battery pack breaks or cracks, do not use it.



Read all of the instructions in the battery charger section of this manual before attempting to charge the battery pack for your respirator.

■ Always use correct battery pack (pack supplied with tool or exact replacement pack). Never install any other battery pack as it will damage the respirator and may create a hazardous condition.

**ADDITIONAL SAFETY
PRECAUTIONS FOR
AIR/PRO**



- Control Of Substances Hazardous to Health (COSHH) recommend that Respiratory Protective Equipment should be stored in a cool dry place.
- For adequate protection the respirator must fit or be adjusted to the size of the head.
- DO NOT clean with proprietary cleaning media or solvents, follow the instruction in manual.
- DO NOT apply paint, solvents, adhesives or self-adhesive labels which are not approved by Trend.
- DO NOT use respirator without filters fitted, with damaged seals and/or damaged visor.
- DO NOT use replacement parts except those supplied by Trend.
- To maintain the full efficiency of the respirator, there must be no alteration to the structure or it's component parts.
- Toxic Dusts on the respirator or filters from usage should be handled in a safe manner in accordance with your chemical or material suppliers instructions. Used filters to be disposed of safely in the same manner.

If further information is required with regards to the respirator, please contact Trend.



**Charge the battery pack before use.
Ensure the respirator is correctly
assembled with the filter and a fully
charged battery pack.**

ITEMS ENCLOSED

- 1 x Airshield Pro complete
- 1 x Airflow indicator
- 1 x Pair TH2P filters
- 1 x 8 Hour rechargeable battery
- 1 x Disposable visor overlay - clear (may be already fitted)
- 1 x Battery charger
- 1 x Pair ear defender clips
- 1 x Carry bag
- 1 x COSHH Record card (UK only)
- 1 x Instruction manual
- 1 x Guarantee card

DESCRIPTION OF PARTS

- A. Cover
- B. TH2P Filter
- C. Battery pack
- D. Head cover & face seal
- E. Switch and contact assembly
- F. Motor
- G. Visor lock knob
- H. Head band assembly
- I. Brow comfort pad
- J. Visor
- K. Visor overlay
- L. Airflow indicator
- M. Charger
- N. Carry bag
- O. Ear defender clip
- P. Crown Strap
- Q. Headband Knob

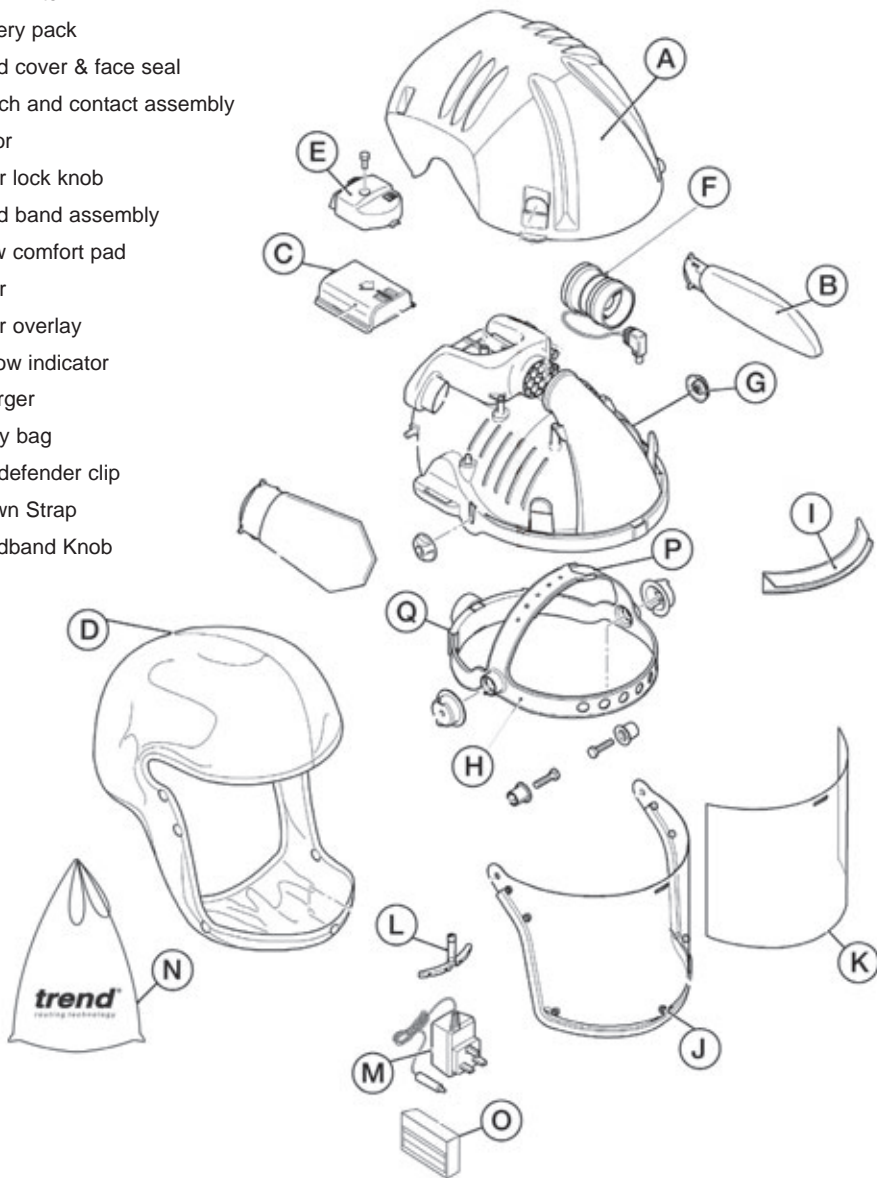

ASSEMBLY, ADJUSTMENT & OPERATION



Battery Pack Installation



The Powered Respirator is supplied with one rechargeable battery pack for eight hours duration.



Battery pack must be initially charged for 24 hours.

Check that the voltage shown on the charger is suitable for the mains supply. A thermal fuse protects the charger against short circuiting and overloading.

- Lift the cover by pressing the forward side tabs inwards and rotating the cover rearwards as shown below:

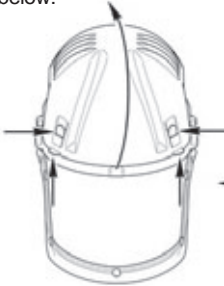

- Slide the battery pack into its housing from behind as shown below.

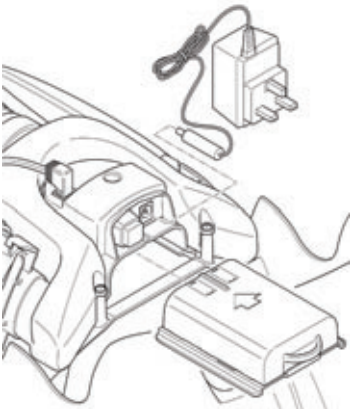

- Refit cover ensuring tabs lock the cover in position.

Battery Pack Charging



- Fit the battery charger connector into the rear of the electronics unit and connect the charger to a mains AC supply. The LED lights up and remains lit even after a full charge has been completed.
- After charging switch off the mains AC supply, remove the charger connector from the respirator.

Battery packs should be initially charged for 24 hours and 14 hours thereafter when fully discharged. Full working capacity of the battery will not be achieved until the battery has been through 3 or 4 complete charging cycles. Please note the light will not extinguish when a full charge has been achieved.

The respirator has a pre-use and low battery audio signal. Leave the contaminated area if the buzzer sounds.



Charger must be disconnected from the mains supply when not in use.

After the charging period, remove the charger from the AC supply socket. An accessory external remote battery charger cradle Ref. AIR/P/7 is also available.



Remote Battery Cradle Accessory Ref. AIR/P/7

- Remove battery pack from the respirator.
- Fit the charger connector into the socket in the remote battery cradle. Connect charger to a mains AC supply.
- Fit the battery into the cradle. The LED lights up and remains lit even after a full charge has been completed.
- After charging of battery, switch off the mains AC supply, remove the battery from the cradle and remove charger connector from the cradle.

Visual Inspection

- Check the face seal material for damage.
- Check the face seal attachment to the respirator chassis and visor.
- Check the visor seal for damage.

Replace any damaged parts including scratched or damaged visors.

Functional Test

The purpose of this test is to ensure that the airflow through the respirator is in excess of the minimum design value of 150 litres per minute.

Proceed as follows:

Ensure that the air filters have been installed correctly as shown.

To fit air filter

- Hold the neck of the fitted air filter and push firmly toward sealing face to release from securing tabs and lift filter upwards to remove. Discard appropriately.

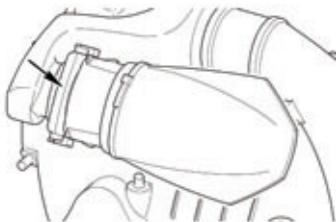
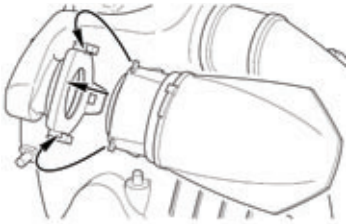

- Locate new air filter against sealing face. Push firmly toward sealing face and downwards. Filter will click in securing tabs.
- Repeat for other filter.
- Refit cover.



Hold plastic neck of air filter to fit and remove. Do not pull on filter.

To correctly use the airflow indicator, the respirator should be turned upside down.

Press the red on/off button to switch on.

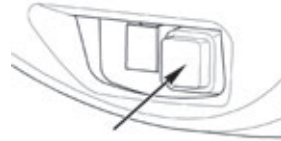

Locate the airflow indicator on the four slots at the front of the respirator. Do not cover the holes on the airflow indicator.

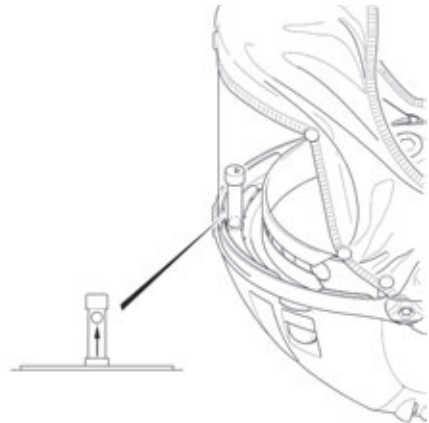

Tilt or shake the respirator slightly to encourage the ball to rise to the top of the indicator. If, when the unit is then returned to an upright position, the ball remains elevated, the airflow is acceptable.

If the red ball is raised to less than half the height of the tube then either the battery charge is low or the filters are blocked and need replacing.

Low Battery Warning



If an audible regular intermittent tone sounds, recharge or replace the battery pack.

Fitting Procedure



- The crown strap has a soft pad that needs to be removed before adjustment. Adjust the crown strap length on the headband so that the headband rests against brow.
- Crown strap adjustment is made by pulling the tab out of the strap and placing the pin into the next suitable hole, once set replace pad.
- Adjust headband diameter by pushing in knob and rotating for head size, release the knob to secure as shown.

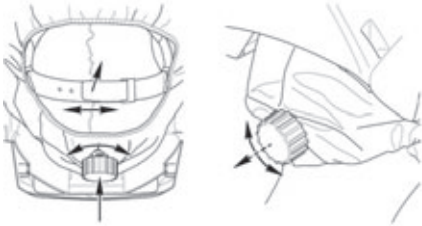

- Ensure face seal is above the ears. Check that the face seal is taut so that there are no gaps between mask and face as shown.



- Switch on the fan/motor by operating the red on/off switch.
- Adjusting the height will affect the fit around the chin.
- Adjusting the face seal will affect the fit at the sides.



Ensure face seal is above the ears.

- Ensure that the face seal around the chin and sides is pulled away from the frame and visor and not towards it.
- Check the fit of the face seal in a mirror and/or run a finger around the line of the face seal to ensure contact.



At very high work rates, the pressure within the AIR/PRO may momentarily become negative at peak inhalation.



Vacate the contaminated area immediately if the airflow is reduced or stops, or the low battery warning buzzer sounds.



If protective clothing is worn, ensure the bottom of the visor is not obstructed.

Removing the Respirator



Vacate from the contaminated area before removing the respirator.

- Raise the visor and switch the fan motor off.
- Pull out the knob to release headband and lift the respirator from the head.
- After finishing using the respirator follow the maintenance procedure.

ACCESSORIES

Please use only Trend original accessories.

Ref. AIR/P/1	TH2P filter pack (pair)
Ref. AIR/P/3C	Visor overlay - clear (pack of ten)
Ref. AIR/P/3G	Visor overlay - green (pack of ten) anti-glare
Ref. AIR/P/4	8 hour battery
Ref. AIR/P/5/UK	230V charger (UK)
Ref. AIR/P/5/EURO	220V charger (Euro)
Ref. AIR/P/7	Remote battery charger cradle
Ref. AIR/WIPE	Airwipes (100 wipes)

MAINTENANCE AND CARE

Respirator Cleaning

After using the respirator follow the procedure below:



Respirator should not be cleaned with compressed air, solvents, sterilising by heat or autoclaving, as this will cause damage.

Precautions are to be taken to prevent inhalation of harmful dust or contaminant on the surface or retained on the filters.

- Carefully remove bulk contamination from the respirator and wipe down with a damp cloth containing a mild detergent solution.
- Clean and sterilise all parts by wiping down the visor, face seal and headband with visor wipes (ref. AIR/WIPE)
(Sodium Hypochlorite or Ethylene Oxide Gas have also been proved effective).

- Do not immerse the respirator in water or any other fluids.
- Do not use organic solvents or abusive cleaning agents on any part of the equipment.
- After cleaning carry out the functional test.



Gamma sterilisation is effective but causes embrittlement of plastic components and is not recommended.

Replace if deficient after the following checks.

1. Excessive abrasion and scratches on the visor.
2. The face seal for its seal to the visor and for holes.
3. Fit and fastenings to the headband.



Scatched or damaged visor may not offer full protection and therefore should be replaced.

Specific Instructions for Cleaning and Disinfection of Visor



Clean with a damp cloth – do not use hydrocarbons, chemicals, cleaning fluids or solvents on the visor. If necessary, a mild solution of washing-up liquid and warm water may be used.

Charger Cleaning

- Dirt and grease may be removed from the exterior of the charger using a cloth or soft non-metallic brush. Do not use water or any cleaning solutions.



Disconnect the charger from the AC outlet before cleaning.

Lubrication

- Your respirator requires no additional lubrication.

Routine Checks

The expected life of the visor is approximately 3 years if well maintained and cleaned. (Care must be taken not to scratch the visor).

This manual contains relevant guidance on routine maintenance; however, you may wish to introduce additional checks as required by COSHH. The following table shows the frequency of these checks.

Operation	Frequency
Clean Internally and Externally	Daily
Visual Inspection	Daily
Charge Battery Pack/Packs	Daily
Functional Test*	Daily, Weekly and Monthly

* Remarks: Dust from wood, grain and cement may suit more frequent replacement of the filter. No filter should be left in the hood/helmet for more than 1 month if in daily use or 3 months if used infrequently.

Monthly - All items checked and signed by Operator.

Quarterly - All items checked and signed by Supervisor.

Storage

- The respirator should be placed in the carry bag, stored within a temperature range of 5°C to 40°C and out of direct sunlight. Replacement filters are to be left in air sealed bags and expiry dates to be checked regularly.

Transportation

- The complete respirator should be transported in the carry bag provided. Good quality commercial packing should be used.

Symptom	Cause	Remedy
Reduced Airflow	Cover air holes blocked Filters clogged Battery flat	Clear air flows Fit a new filter Recharge battery or fit recharged battery pack
No airflow	Respirator switched OFF Switch faulty Battery pack not fitted Battery pack discharged Fan-motor unit failure	Press switch to ON Replace switch housing Fit a fully charged battery pack Fit a fully charged battery pack Fit a replacement fan-motor unit

REPLACEMENT OF SPARE PARTS



Replacement parts and accessories supplied by Trend should only be used. The use of accessories not supplied by Trend will not be guaranteed and invalidate such National approvals as held by Trend. Modifications to the respirator will make the approvals invalid and the use illegal under National Laws and Guidance.

Trend replacement parts and accessories, must only be used with the respirator.

Battery Pack



- Lift the cover by pressing the forward side tabs inwards and rotating the cover rearwards as shown below.

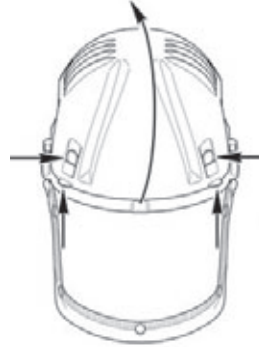

- Slide the battery pack out of its housing.
- Replace with new battery.
- Refit cover ensuring tabs lock the cover in position.

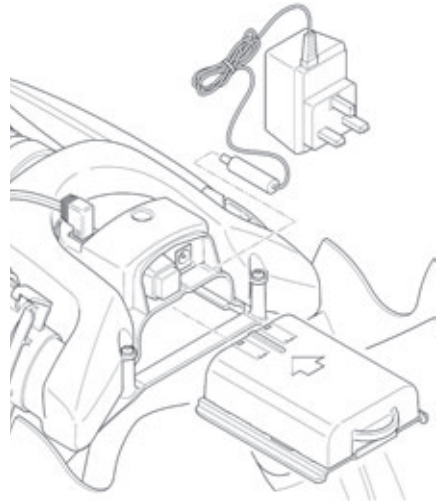

Air Filter 

- To replace air filter, lift the cover as shown.



- Hold the neck of the fitted air filter and push firmly towards sealing face to release from securing tabs and lift filter upwards to remove. Discard appropriately.



- Locate new air filter against sealing face. Push firmly toward sealing face and downwards. Filter will click in securing tabs.
- Repeat for other filter.
- Refit cover.



Precautions are to be taken to prevent inhalation of harmful dust or contaminant on the surface or retained on the filter and inside the cover.

Face Seal

Replace the face seal as shown.

- Starting from the centre of the visor, pop up studs on face seal. Release from front of helmet.



- Unfasten the crown strap on the headband and release elastic loops on each side.
- Pull face seal over the headband knob and remove face seal from respirator.
- Tuck edge strip of new face seal under headband and secure and close tape of respirator. Slip the elastic loops over headband knob and secure to visor pop studs.

Face seals should be stored out of direct sunlight and replaced at least every 5 years.

Visor 

- Remove the seven face seal pop studs from visor.
- Replace the old or damaged visor assembly as shown.

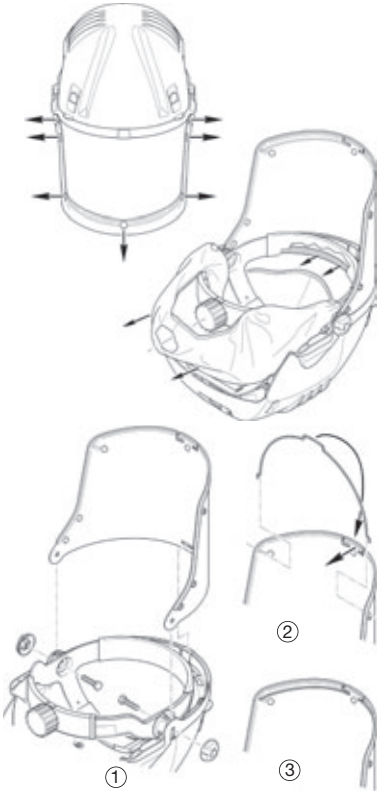

- Release nuts and push screws inwards, release the front tab and lift visor from the helmet.
- Fit replacement visor ensuring slot in visor locates on tab and bottom edge in grooves, secure with screws and nuts.
- Fit visor stiffener wire. Insert the wire ends into the outer slots provided and rotate to engage securely in the centre slot.
- Visors should be stored out of direct sunlight and replaced at least every 5 years.

Headband 

Remove face seal and visor as shown.

Install a new headband assembly as shown.

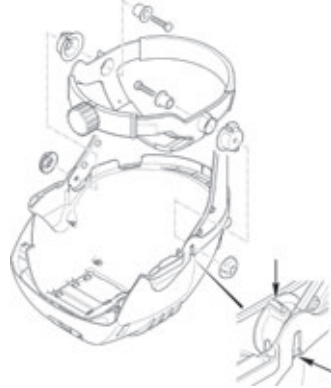

- Release nuts and screw and remove the headband from the helmet.
- Assemble anti-rotating cap and screw retainer to headband noting that anti-rotating caps are marked 'L' (left) and 'R' (right).
- Position the headband in the helmet ensuring that the tabs on the anti-rotating cap locate in the helmet.
- Fit screws through retainer, anti-rotating cap and visor secure with nuts.

Visor Overlay

- Peel away visor protector and ensure visor surface is clean.
- Peel the backing paper from adhesive strips on replacement visor protector. Position centrally onto visor surface, press down adhesive strips and remove protective paper.

Fan-Motor Unit



Lift the cover. Replace fan/motor assembly as shown below:

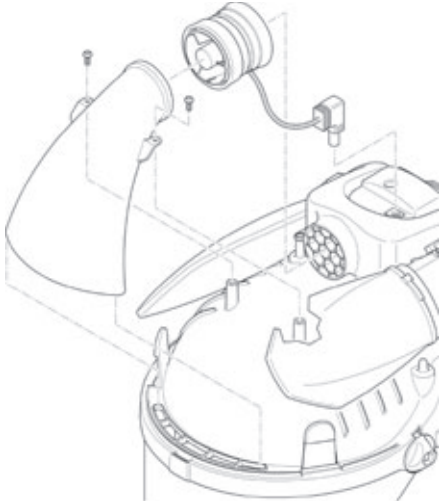

- Disconnect fan/motor electrical lead from the electronics unit.
- Remove the two screws securing the front air duct. Lift the air duct from locating lip and pull fan/motor from rear air duct. Separate fan/motor from front air duct.
- Fold back both seals on replacement fan/motor assembly. With electrical lead point downwards locate with front air duct and secure by unfolding seal over duct.
- Connect electrical lead to electronics unit.
- Locate front air duct in lip and fan/motor with rear air duct, tuck excess cable under fan/motor unit and unfold seal to secure. Secure air duct with screws.
- Ensure both seals are fully engaged with ducts and are fully unfolded, failure to do so may compromise the unit's performance.

Electronics Unit / Switch Housing



Lift the cover and replace the electronics unit as shown below.

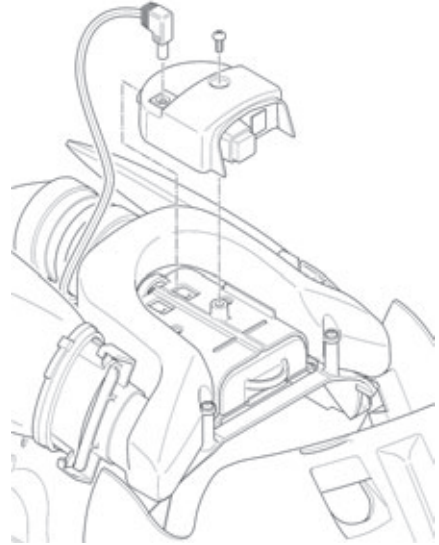

ENVIRONMENTAL PROTECTION



Recycle raw materials instead of disposing as waste.

Accessories and packaging should be sorted for environmentally-friendly recycling.



Separate collection. This product must not be disposed of with normal household waste.

Household User

Local regulations may provide separate collection of electrical products from the household, at municipal waste sites or by retailer when you purchase a new product.

Please call Trend Customer Services for advice as to how to dispose of unwanted Trend electrical products in an environmentally safe way or visit www.trend-uk.com

Business User

Please call Trend Customer Services for disposal of unwanted Trend electrical products.

Rechargeable Batteries and the Environment



This unit uses Nickel-Metal Hydride (Ni-MH) batteries. When the battery pack needs replacing, we recommend the following:-

Ni-MH

Discharge the energy from the batteries by running the batteries down completely, and then remove them from the respirator.

Ni-MH cells are recyclable; so do not throw them away with your household waste. They may end up in an incinerator or landfill, which must be avoided.

Instead, take the batteries to a Trend Service Agent, your local distributor or a local recycling station. If necessary, contact your local municipality for disposal information. The collected batteries will be disposed of properly and/or used for recycling purposes.

GUARANTEE

The unit carries a manufacturer's guarantee in accordance with the conditions on the enclosed guarantee registration card.

For the location of your nearest Trend Service Agent, please call Trend Customer Services or see Stockist Locator at www.trend-uk.com

Please use only Trend original spare parts.

AIR/PRO - SPARE PARTS LIST			V4.0 10/2016
No.	Qty	Desc.	Ref.
1	1	Fan/Motor	WP-AIR/P/01
2	1	Airflow Indicator	WP-AIR/P/02
3	1	Head Cover & Face Seal	WP-AIR/P/03
4	-	-	-
5	1	Switch & Contact Assembly	WP-AIR/P/05
6	1	Carry Bag	WP-AIR/P/06
7	1	Visor	WP-AIR/P/07
8	1	Cover	WP-AIR/P/08
10	1	Headband Brow Comfort Pad	WP-AIR/P/10
15	1	Ear Defender Clip (Pair)	WP-AIR/P/15
16	1	Headband Fixing Kit (Pair)	WP-AIR/P/16
17	1	Headband Top Frame Crown Pad	WP-AIR/P/17
18	1	Headband Kit >10/2016	WP-AIR/P/18
19	1	TH2P Filter Pack (Pair) - PL01170-2SP	AIR/P/1
20	0	Visor Overlay - Clear (Pack of 10)	AIR/P/3C
21	1	8 Hour Battery	AIR/P/4
22	1	Charger 230V UK Plug	AIR/P/5/UK
	1	Charger 230V Aus/NZ Plug	AIR/P/5/ANZ
	1	Charger 220V Euro Plug	AIR/P/5/EURO
23	1	COSHH Record Card (UK only)	LEAF/AIR/CRC
24	1	Manual	MANU/AIR/PRO

AIR/PRO - SPARE PARTS LIST

V4.0 10/2016

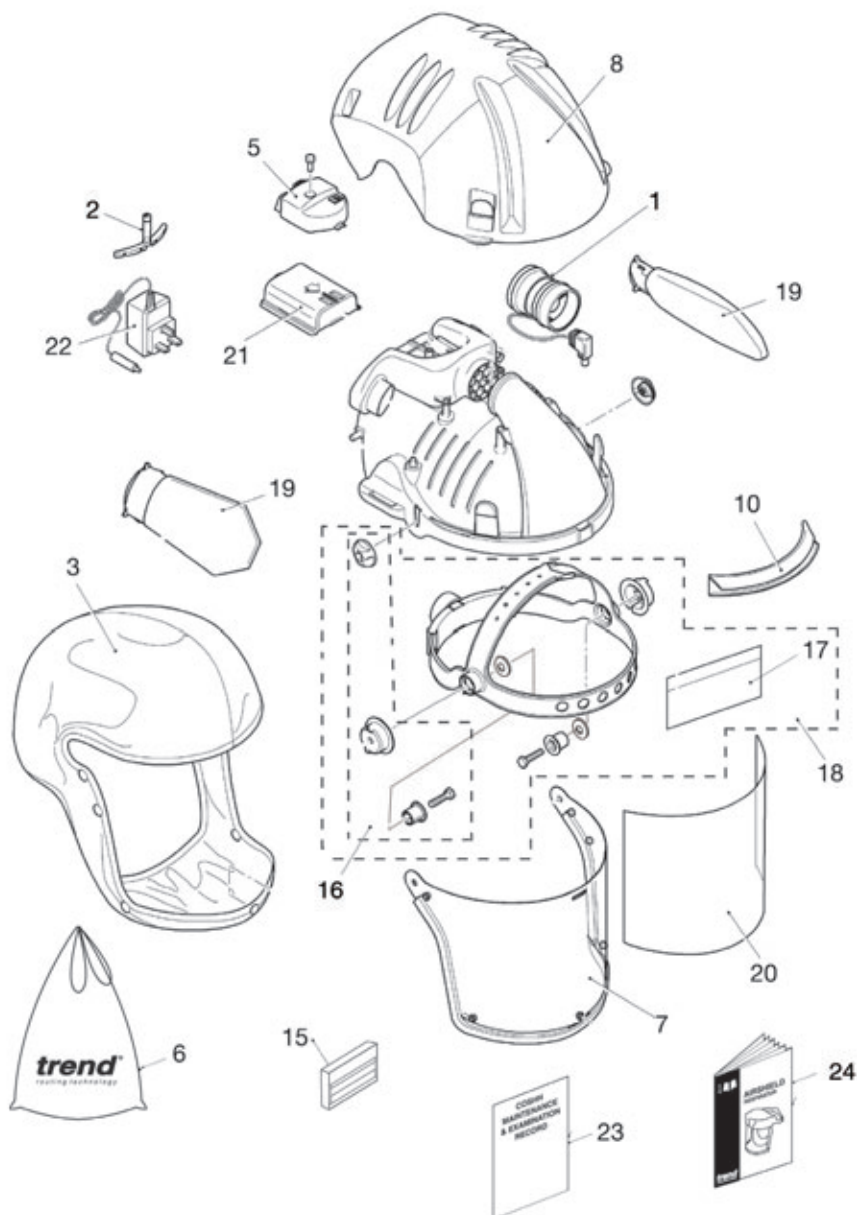

MANU/AIR/PRO V5.1



RECYCLABLE

Trend Machinery & Cutting Tools Ltd.

Odhams Trading Estate St Albans Road
Watford WD24 7TR England

Tel: 0044(0)1923 249911

technical@trendm.co.uk

www.trend-uk.com