



INSTRUCTIONS FOR

SILENT ELECTRIC ROTARY SCREW COMPRESSORS 270ltr BELT DRIVE 10hp

MODEL NO: **SSC12710 & SSC12710D**

Thank you for purchasing a Sealey product. Manufactured to a high standard, this product will, if used according to these instructions, and properly maintained, give you years of trouble free performance.

IMPORTANT: PLEASE READ THESE INSTRUCTIONS CAREFULLY. NOTE THE SAFE OPERATIONAL REQUIREMENTS, WARNINGS & CAUTIONS. USE THE PRODUCT CORRECTLY AND WITH CARE FOR THE PURPOSE FOR WHICH IT IS INTENDED. FAILURE TO DO SO MAY CAUSE DAMAGE AND/OR PERSONAL INJURY AND WILL INVALIDATE THE WARRANTY. KEEP THESE INSTRUCTIONS SAFE FOR FUTURE USE.



Refer to instruction manual



Wear protective gloves



Wear eye protection



Warning! Hot surface



Wear ear protection



Wear protective clothing



Warning! Automatic startup



Indoor use only

1. SAFETY

1.1. ELECTRICAL SAFETY

- **WARNING!** Electrical installation of compressor to a 3-phase 415Volt supply must only be carried out by a qualified electrician. Make sure the power supply cable is correctly connected to the earth. It is the user's responsibility to read, understand and comply with the following: You must check all electrical equipment and appliances to ensure they are safe before using. You must inspect power supply leads, plugs and all electrical connections for wear and damage. You must ensure the risk of electric shock is minimised by the installation of appropriate safety devices. An RCCB (Residual Current Circuit Breaker) should be incorporated in the main distribution board. You must also read and understand the following instructions concerning electrical safety.
- 1.1.1. The **Electricity At Work Act 1989** requires all portable electrical appliances, if used on business premises, to be tested by a qualified electrician, using a Portable Appliance Tester (PAT), at least once a year.
- 1.1.2. The **Health & Safety at Work Act 1974** makes owners of electrical appliances responsible for the safe condition of the appliance and the safety of the appliance operator. If in any doubt about electrical safety, contact a qualified electrician.
- 1.1.3. Ensure insulation on all cables and the product itself is safe before connecting to mains power supply.
- 1.1.4. Ensure that cables are always protected against short circuit and overload.
- 1.1.5. Regularly inspect power supply, leads, plugs and all electrical connections for wear and damage, especially power connections, to ensure that none are loose.
- 1.1.6. **IMPORTANT:** The mains voltage must correspond with that indicated on the electrical data nameplate for each machine; the admitted tolerance must remain within +/- 6%. For example:
Voltage, 400Volt: minimum tolerance 376Volt
Voltage, 400Volt: maximum tolerance 424Volt
- 1.1.7. **DO NOT** pull the powered appliance by the power cable.
- 1.1.8. **DO NOT** pull power plugs from sockets by the power cable.
- 1.1.9. **DO NOT** use worn or damage leads, plugs or connections. Immediately replace or have it repaired by a qualified electrician.
- 1.1.10. Electrical connection to mains power supply.
Three-phase compressors are supplied with cable, but without plug. The plug of the power supply cable must never be used as a switch but must be plugged into a power socket that is controlled by an adequate differential switch (magneto thermal switch). It is advisable to install the connector, magneto thermal switch and fuses near to the compressor (3mtr away at the most). The magneto thermal switch must be rated at 25A and the fuses must be 32A. The fuse rating refers to the type gI (standard) fuse. If cartridge fuses type aM (delayed) are used the rating should be reduced by 20%. The rating of the magneto thermal switches refer to switches type K.
Ensure that the installed power in kW is at least double the input of the electric motor. All silent rotary screw compressors have 'Star/Delta' starting, which enables the motor to start-up with as little electrical energy consumption as possible.
- 1.1.11. This product must be fitted with a 3-phase plug according to the diagram, and will require a minimum of 16Amps per phase, (preferably 32Amp) electrical supply. You must contact a qualified electrician to ensure an appropriately fused supply is available. Connect GREEN/YELLOW wire to earth (E) Terminal.  Connect the live wires to live 1, 2 and 3. Check for the correct direction of rotation (see arrow on side panel) to confirm correct wiring of 3-phase plug when you first run the compressor (refer to section 5.8). When completed, check that there are no bare wires, that all wires have been connected correctly, that the cable external insulation extends beyond the cable restraint and that the restraint is tight. Never use the earth connection instead of the neutral. The earth connection must be achieved according to the EN 60204 industrial safety standards.
- 1.1.12. The importance of the earth connection. This compressor must be connected to earth to safeguard the operator against electrical shocks whilst the machine is in use. The electrical connection must be carried out only by a qualified electrical engineer. The earth wire of the power supply cable of the compressor must be connected only and exclusively to the PE pin of the terminal board of the actual compressor.

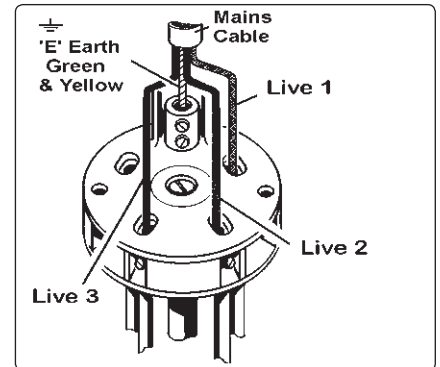

- 1.1.13. If it is necessary to replace a plug on the power supply cable ensure that the earth wire is connected. All electrical repairs must be carried out exclusively by a qualified electrical engineer. Avoid all risks of electric shocks. Never use the compressor with a damaged electrical mains supply cable. Regularly check all electrical cables. Never use the compressor in or near water or near a hazardous area where electrical shocks may be encountered.
- 1.1.14. Check the rotation direction.
These 10hp compressors are equipped with a phase sequence relay (KR) that, every start, checks the rotation direction and, in case of wrong rotation direction, stops the compressor (see fig.4 and fig.14). Disconnect the compressor from the mains power, reverse two phases of the power cable on the terminals for connection of the cable line and restart the compressor.
- 1.2. Safety (Installation).**
IMPORTANT! The compressor must be installed and commissioned by qualified personnel.
- ✗ **DO NOT USE THE COMPRESSOR IF IT IS FAULTY.** Ensure that the compressor is in good order and condition before use. If the compressor is noisy or vibrates excessively when running, stop it immediately. If in any doubt **DO NOT** use the unit and contact an electrician/service agent.
 - ✓ Operate the compressor at the rated voltage.
 - ✓ Operate the compressor at the voltage specified on the electric data plate. You could damage or burn-out the motor and other electric components if the compressor is operated at a higher or lower voltage than its rated voltage.
 - ✓ Use the compressor correctly. Operate the compressor in compliance with the instructions provided in this manual. **DO NOT** allow children to use the compressor or those who are not familiar with it.
- 1.3. Safety (Operational Area/Environmental).**
- ✓ Operational area. Keep the work area clean and remove any tools or unnecessary items that are not required. Install the compressor on a firm surface away from any heat sources.
 - ✓ Use the compressor in a well ventilated area. Ensure there is adequate ventilation space all around the compressor.
 - DO NOT** use the compressor in the presence of flammable liquids or gas. The compressor may produce sparks while running. **DO NOT** use the compressor where there may be paints, gasoline, chemical compounds, glues or any other flammable or explosive material.
 - ✓ Keep unauthorised persons away from the working area. All non-essential persons must be kept at a safe distance from the operational area. Prevent children or anyone else from touching the power supply cable of the compressor.
 - DO NOT** use the compressor outdoors. **DO NOT** install the compressor in damp or wet locations or in areas where condensation may form.
 - DO NOT** cover the compressor or restrict air flow around the machine whilst operating.
 - ✓ If the compressor is used for painting jobs.
 - a) **DO NOT** work in closed rooms or near naked flames.
 - b) Check that the area selected for spraying is provided with an air change system or adequate ventilation.
 - c) Wear face and nose mask.
 - ✓ When the compressor is not in use, it should be switched off, isolated from the mains supply and the air drained from the tank.
 - ✓ Store the compressor appropriately. If the compressor is not used immediately, it must be stored in a dry place away from atmospheric agents until it is installed.
- 1.4. Safety (Air/Pressure).**
- WARNING!** The air tank is a pressure vessel and the following safety measures apply:
 - DO NOT** tamper with the safety valve and **DO NOT** modify or alter the tank in any way. **DO NOT** strap anything to the tank.
 - DO NOT** subject the tank to impact, vibration or to heat and **DO NOT** allow contact with abrasives or corrosives.
 - DO NOT** drill, weld or deform the compressed air tank.
 - DO NOT** unscrew the outlet connection when the tank is pressurised. **DO NOT** unscrew the connection for any reason whatsoever without first checking if the tank is discharged.
 - ✓ Ensure the air supply valve is turned off before disconnecting the air supply hose.
 - ✓ Pneumatic circuit. Use recommended pneumatic hoses. Read the instructions regarding any accessory used with the compressor. Ensure the safe working pressure of any air appliance used exceeds the compressor maximum pressure.
 - ✓ Ensure the air hose is not tangled, twisted or pinched.
 - DO NOT** operate the compressor without an inlet air filter.
- 1.5. Safety (Training/Good practice).**
- DO NOT** allow anyone to operate the compressor unless they have received full instructions and adequate training.
 - ✓ Keep these use and maintenance instructions for future reference and make them available to the compressor operator. The operator must be familiar with all the controls and compressor characteristics before starting to work with the machine.
 - ✓ Avoid accidental start-up. Ensure that the main switch is turned OFF before connecting the compressor to the electrical power supply. Never move the compressor while it is connected to the electrical power supply or when the tank is pressurised.
 - ✓ Precautions for the power supply cable. **DO NOT** disconnect the power supply plug by pulling on the cable. Keep the cable away from heat, oil and sharp edges. **DO NOT** stand on the electrical cable or squash it under heavy weights.
 - ✓ Look after the compressor with care. Follow the maintenance instructions. Inspect the power supply cable on a regular basis and if damaged it must be repaired or replaced by an authorised service centre. Visually check the outside appearance of the compressor, that there are no visual anomalies. Contact your nearest Sealey dealer if necessary.
 - ✓ Check for faulty parts or air leaks. Before each use, visually inspect the compressor. If a safety guard or other parts are damaged, they must be checked carefully to evaluate whether they continue to provide the intended protection.
 - ✓ Check the alignment of moving parts, hoses, gauges, pressure reducers, pneumatic connections and every other part that may be crucial for the normal operational efficiency of the compressor. All damaged parts must be properly repaired or replaced by an authorised service centre or replaced following the instructions provided in instruction manual.
 - ✓ Turn the compressor off when it is not in use.
 - ✓ When the compressor is not in use turn the main on/off switch to the off position ("0").
 - DO NOT** deface the certification plate attached to the end of the compressor tank.
- 1.6. Safety (Personal/Mechanical).**
- ✗ **DO NOT** use the compressor without the safety guards fitted. Never use the compressor without all the safety guards properly fitted in their correct place (i.e. panelling, belt guard, safety valve). If these parts are to be removed for maintenance or servicing purposes, ensure that they are correctly reinstalled before using the compressor again.

- ✗ **DO NOT** touch hot parts of the compressor. To avoid burns **DO NOT** touch the compressor cylinder, cylinder head, motor or pipe from head tank as these may be hot and will remain so for some time after shutdown.
 - ✓ Always wear goggles or an equivalent means of eye protection. Never direct compressed air towards any part of your body or that of others.
 - ✓ Wear appropriate clothing. **DO NOT** wear unsuitable clothing, ties or jewellery as these may get caught up in moving parts. Tie back long hair or wear a cap to cover your hair if necessary.
 - ✓ Protect yourself against electric shocks. Avoid accidentally touching the metal parts of the compressor with your body, such as pipes, the tank or metal parts connected to earth. Never use the compressor where there is water or in damp rooms.
- 1.7. Safety (Maintenance/Parts).**
- WARNING!** Compressor must only be serviced by an authorised agent. **DO NOT** tamper with, or attempt to adjust pressure switch or safety valve.
 - ✓ Spare parts. Use only original and identical spare parts to replace worn or damaged ones. Repairs must be made exclusively by an authorised service agent.
 - ✓ Maintenance. Regular maintenance of the compressor is essential to ensure a long working life. Follow the maintenance schedule detailed in these instructions.
 - ✗ **DO NOT** dis-assemble compressor for any reason. The unit must be checked by qualified personnel only.
 - ✓ Drain condensation from tank daily, inspect inside walls for corrosion every three months and have a detailed tank inspection carried out annually. Tank shell must not fall below the certified thickness at any point.
 - ✓ When not in use, store the compressor carefully in a safe, dry, childproof location.
 - ✓ Keep the intake grills clean. Keep the motor ventilation grills clean. Regularly clean these grills if the work area is particularly dirty.
 - DO NOT** clean plastic parts using solvents.
 - ✓ Solvents such as gasoline and thinners or other compounds that contain hydrocarbons may damage the plastic parts. Clean them with soft cloth and soapy water or other suitable liquids.
 - ✓ Use original spare parts only. The use of non-original spare parts will invalidate the warranty and could seriously damage the compressor. Original spare parts are available from your local sealey dealer.
 - ✓ Moving or maintaining the compressor. Disconnect the compressor from the electric power supply and completely discharge the pressure from the tank before moving it or carrying out any service, inspection, maintenance, cleaning, replacing or inspection of parts.
 - ✓ Ensure that each screw, bolt and guard is firmly secured in place.
 - WARNING!** If an electrical fuse blows, ensure that it is replaced with one of identical type and rating.
- 1.8. Safety (Common Sense).**
- WARNING!** The warnings, cautions and instructions discussed in this instruction manual cannot cover all possible conditions and situations that may occur. It must be understood that common sense and caution are factors which cannot be built into this product, but must be applied by the operator.
 - ✓ Use the compressor exclusively for the applications specified in this instruction manual. The compressor is a machine that produces compressed air. Never use the compressor for purposes other than those specified in this instruction manual.
 - WARNING!** Pay attention to everything you do. Use your common sense. **DO NOT** use the compressor if you are tired. The compressor must never be used if you are under the influence of alcohol, drugs or intoxicating medicines.
 - ▲ **DANGER! DO NOT** direct the jet of compressed air directly towards your body. To avoid all risks never direct the jet of air towards other people or animals.
 - ✗ **DO NOT** stop the compressor by pulling on the power supply cable (unless in an emergency). Use the on/off buttons on the control panel to stop the compressor.
 - ✗ **DO NOT** modify the compressor in any way. Contact your local sealey dealer for all repairs required. Any unauthorised modification may impair the efficiency of the compressor and may also cause serious accidents for those who **DO NOT** have the technical skill required to make such modifications.
 - ✓ We reserve the right to make modifications where necessary without notice.

2. INTRODUCTION

High performance, top of the range screw compressors offer high continuous output of air with low running costs. One of the most economical ways to get compressed air 24/7 with minimal downtime. Very few moving parts means servicing/maintenance will be less frequent and less expensive compared to an equivalent piston compressor. Insulated Class F 10hp motor with IP54 protected control box which is easy to operate with digital display showing key information like air pressure, oil temperature and maintenance schedules. Features an insulated outer casing to minimise noise (67dB.A at 1m) and offers protection to inner components. Also fitted with a drain valve tap at base of unit to ensure easy function tank drain when required. Model No. SSC12710D has a built in air dryer allowing the unit to produce cleaner purified air especially required when paint spraying. The dryer reduces the air temperature and helps prevent corrosion which can cause air lines and fittings to become clogged.

3. SPECIFICATION

Model no:	SSC12710	SSC12710D
Motor Output (hp)	10	10
Voltage/Phase	415/3ph	415/3ph
Rated Supply (Amp)	32	32
Max Free Air Delivery cfm (ltr/min)	30.2(860)	30.2(860)
Max. Pressure psi/bar	145/10	145/10
Tank Capacity (ltr)	270	270
Weight kg	217	257
Noise Level dB(A)	67	67
Outlet	1/2" BSP Female Tap	1/2" BSP Female Tap
Overall Size (WxDxH)	1550 x 590 x 1255	1550 x 590 x 1255

4. PREPARATION

- 4.1. Transporting and handling the packed compressor. The packed compressor must be transported by qualified personnel using a forklift truck. Before moving the compressor ensure that the load-bearing capacity of the forklift truck is sufficient to take the weight to be lifted. Position the forks exclusively as shown in fig.1A. Once the forks have been positioned in the points indicated, lift slowly and smoothly. Never stand near the area where the compressor is being handled and never stand on the crate while it is being moved.



4.2. **Unpacking the compressor.**

- 4.2.1. To avoid damages and to protect the compressor during transport it is placed on a wooden pallet, to which it is secured by nuts and bolts. A cardboard cover is then strapped to the pallet. All the shipping and handling information and symbols are printed on the compressor packing. Using a forklift truck take the compressor as near as possible to the place where it is to be installed.

NOTE! The machine must be unpacked by qualified personnel using appropriate tools and equipment.

- 4.2.2. Release the strapping holding the cardboard cover onto the pallet and with the help of a second person lift the cover up and off the compressor as shown in fig.1B.
- 4.2.3. Inspect the compressor for any shortages or damage. If anything is found to be missing or damaged contact your supplier.
- 4.2.4. Remove the four sets of nuts and bolts that secure the compressor feet to the pallet as indicated in fig.1C.

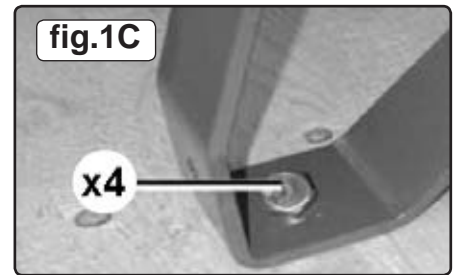

- 4.2.5. Dispose of the packaging in accordance with local authority regulations.

4.3. **Storing the packed and unpacked compressor.**

If the compressor is not to be unpacked immediately store it in a dry place at a temperature between +5°C and +40°C and sheltered away from the weather. If the compressor is not used immediately after unpacking it, place sheets over it to protect it from dust, which may settle on the components. The oil is to be replaced and the operational efficiency of the compressor is to be checked if it is not used for long periods.

5. INSTALLATION

- 5.1. The compressor must be installed as indicated in these instructions. Any machine failure due to incorrect installation will invalidate the warranty.
- 5.1.1. The compressor should be operated on a flat surface.
- 5.1.2. Check the oil level, consulting the oil level inspection window. Use only synthetic oil (see maintenance section for oil specification).
- 5.1.3. Confirm the mains voltage corresponds with the voltage shown on compressor data plate. Have a qualified electrician wire in the compressor in accordance with Section 1.1.
- 5.1.4. When fully installed, start the compressor and ensure that everything is in good working order before operational use. Check the direction of rotation (see section 5.8) to confirm correct wiring of 3-phase plug. Re-check oil levels.

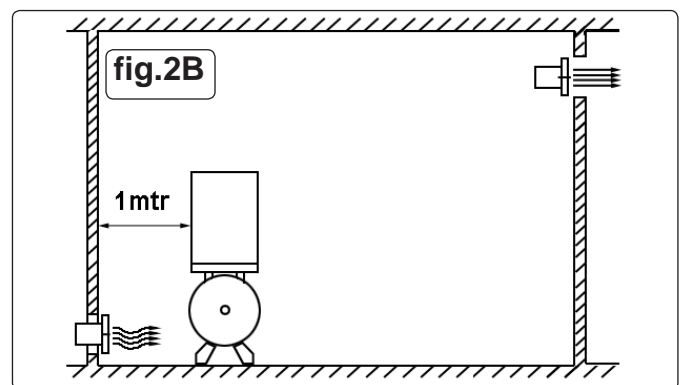
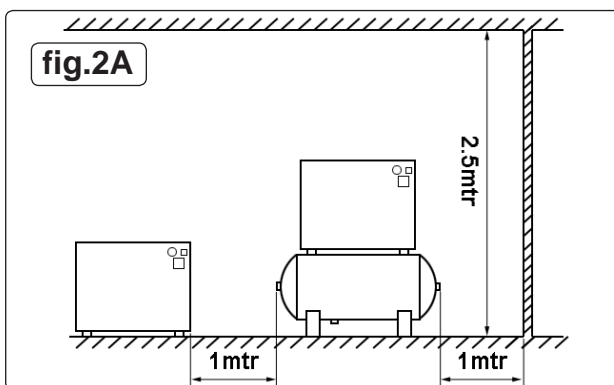

5.2. **Room temperature.**

- 5.2.1. For correct functioning of the compressor the room temperature must not be lower than 5°C or higher than 45°C.
- 5.2.2. If the compressor is operated at a room temperature lower than the minimum value, the condensate could be separated within the circuit resulting in water mixing with the oil. The resulting deterioration in oil quality would fail to guarantee the even formation of an effective lubricating film between moving parts with the possibility of seizure.
- 5.2.3. If the compressor works at a room temperature higher than maximum value, the compressor would take in air that is too hot, which would prevent the heat exchanger from adequately cooling the oil in the circuit, raising the working temperature of the machine, thus causing the thermal safety device to trip, which stops the compressor due to the excessive temperature of the air/oil mixture at the screw outlet.
- 5.2.4. The maximum temperature of the room is to be measured while the compressor is running.

5.3. **Ventilation requirements.**

- 5.3.1. The room must be provided with outlets that lead outdoors near the floor and ceiling that will allow the natural circulation of air. If this is not possible, install some fans or extractors (see fig.2B) that guarantee an air flow rate 50% higher than that taken in by the compressor (min. flow 2500m³/h). Ducts for the inlet and outlet of the air can be used in unfavourable environments. These ducts must be the same size as the intake and delivery grills. If these ducts are longer than 3 meters contact the Authorised Service Centre.

5.4. **Space required for maintenance.**

5.4.1. The compressor must be installed in a large room that is well-ventilated, dust-free and sheltered away from rain and frost. The compressor takes in a large amount of air that is required for internal ventilation. A dusty atmosphere would in time cause damage and inefficient performance. Dust drawn into the machine will be taken into the air filter causing it to clog rapidly. Incoming dust will also settle onto the components and will be blown against the cooling radiator, consequently compromising the efficiency of the heat exchanger. It is therefore obvious that the cleanliness of the area in which the compressor is installed is crucial for the correct of the machine, avoiding excessive running and maintenance costs. To facilitate maintenance and to create a favourable circulation of air, the compressor must have sufficient free space all around it as shown in figures 2A & 2B.

5.5. **Lighting.**

5.5.1. The compressor has been designed with the intention of minimising areas of shade in order to facilitate the operator's interaction with the compressor both from a control and a maintenance point of view. The lighting system in the area of installation should be configured to further enhance this interaction and should be considered as crucial for the operator's safety. Therefore, the room in which the compressor is installed must be neither under lit nor over lit, and without shadow zones, dazzling lights or stroboscopic effects due to the lighting.

5.6. **Unsuitable environmental conditions.**

5.6.1. **DO NOT** install the compressor in an environment where there is a risk of fire and/or explosion.

5.6.2. **DO NOT** install the compressor in an environment where there is a risk that the machine may overheat. (Maximum permitted operating temperature 45°C).

5.6.3. **DO NOT** install the compressor in an atmosphere where the humidity will be higher than 80%.

5.6.4. **DO NOT** install the compressor at an altitude of more than 1000m.

5.6.5. This compressor is designed to work with a tank of a specific size i.e. 270ltr. No liability will be accepted for any related malfunctions or problems resulting from the compressor being connected to a smaller tank. The compressor should not be modified in any way.

5.7. **Positioning the compressor.**

5.7.1. Once the position in which the compressor is to be installed has been identified ensure that the compressor is set on a flat surface. No special foundations or bases are required for the compressor.

5.7.2. Lift the compressor using a forklift truck (forks at least 900mm long) and insert the vibration-damping pads (1) into the transit bolt holes (2) in the metal feet as shown in fig.3. **DO NOT** secure the compressor rigidly to the floor.

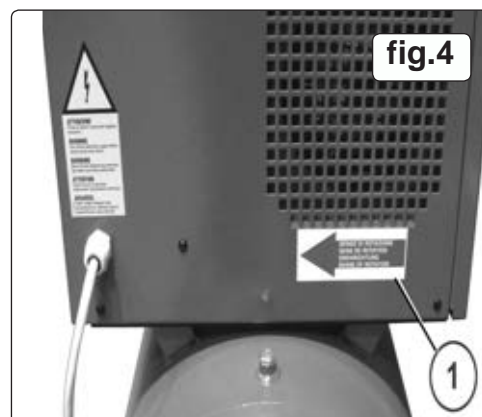
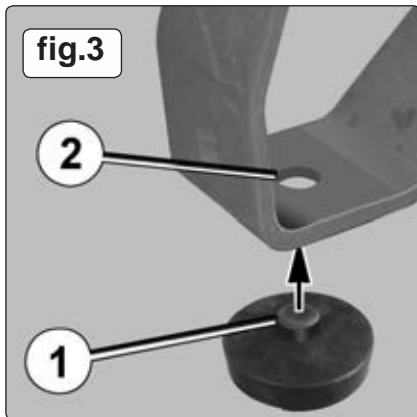

5.8. Electrical connection to mains power supply. Refer to section 1.1 (Electrical safety).

5.8.1. Check the rotation direction during the installation procedure. (See fig.4-1)

These 10 Hp compressors are equipped with a phase sequence relay (KR), see fig.5, that during every start up, checks the rotation direction and, in case of wrong rotation direction, stops the compressor (fig.14 error message on the control panel). Disconnect the compressor from the mains power, reverse two phases of the power cable on the terminals for connection of the cable line and restart the compressor. This procedure should be carried out by a qualified electrician.

5.9. Connecting to the tank compressed air outlet.

5.9.1. When connecting to the tank compressed air outlet always use pneumatic hoses with the maximum pressure characteristics and cross appropriate to the output of the compressor. Connect to the compressor using the 1/2" female BSP fitting shown in fig.6-1. Use hose of same diameter (or greater) as the compressor outlet. If a connection hose leaks or is faulty never try to repair it but replace it with a sound one.

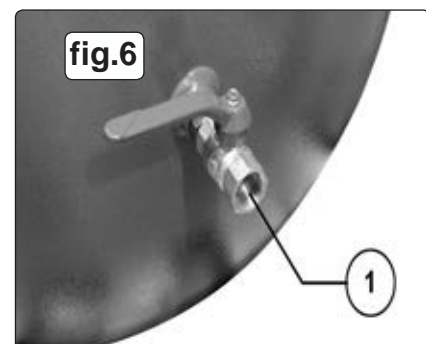
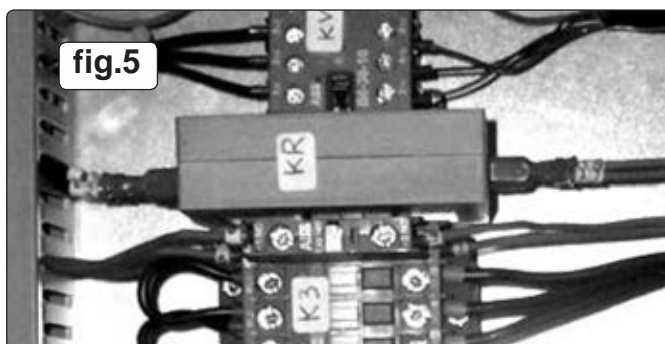

6. OPERATION

- ❑ **WARNING!** Ensure that you have read, understood and apply Section 1 safety instructions.
- IMPORTANT!** The use of extension leads to connect this compressor to the mains is not recommended as the resulting voltage drop reduces motor, and therefore screw performance which may cause damage to your compressor.
- NOTE:** Take care when selecting tools for use with the compressor. Air tool manufacturers normally express the volume of air required to operate a tool in cubic feet per minute (cfm). This refers to free air delivered by the compressor ('air out') which varies according to the pressure setting. **DO NOT** confuse this with the compressor displacement which is the air taken in by the compressor ('air in'). 'Air out' is always less than 'air in' due to losses within the compressor.

6.1. Operational principle.

Air is drawn in through the air filter and passes through a valve that controls its flow rate to the screw where it mixes with the oil and is compressed. The air/oil mix produced by compression is passed to a tank where an initial separation by gravity takes place. The oil, being heavier, settles to the bottom. It is then cooled and sent through a heat exchanger, filtered and injected into the screw again. (The temperature is kept under control by an electric fan that is directly controlled by a thermostat fitted on the heat exchanger). The oil is required to reduce the heat produced by the compression processes, to lubricate the bearings and to maintain the screw lobes coupling. The air is then sent through an oil separator filter to be additionally purified from residue oil particles. It is cooled by means of another heat exchanger producing a low temperature output with acceptable oil residues (<3p.p.m). A safety system monitors the crucial points of the machine and indicates any abnormal conditions. The temperature of the air/oil mix at the screw outlet is controlled by a thermostatic probe, which stops the compressor if the temperature becomes too high.

6.2. When the compressor is connected to power supply the display shows initial screen shot (see fig.8) By pushing the

button (1), the star-delta start up procedure begins. When the maximum pressure is reached, set by the pressure switch, the compressor starts the idle running and the solenoid valve is unexcited. The idle running time lasts 120 seconds, if during this time there's no air requirement from the line, the motor turns off, and it will restart as soon as the air pressure drops down to the minimum set.

6.2.1. By pushing button (2) the compressor stops.

6.2.2. If button (1) is pushed during the stop procedure, after 30 seconds (restart time) the compressor is ready to start again.

NOTE: in case the button (2) is accidentally pushed immediately after button (1), and when the motor is still in "star" connection, the motor stops immediately and the display shows the text "OFF". Pushing the button (1) (even after very short time) the motor starts immediately as described above.

6.3. Controls Panel / Display

6.3.1. The control panel contains a set of buttons that are used for the main operational and control functions of the compressor. A graphic display uses symbols to indicate the state of the machine (see figs. 8, 9, 10, 11, 12, 13, 14 below).

6.3.1.1. Air-end delivery temperature (5) (fig.8) - Possible alarms. The display shows temperature in °C or °F depending on setting.

6.3.1.2. The HIGH temperature alarm is 105°C (221°F). To reset the alarm the temp. has to drop below 95°C (203°F). In the case of a high temperature alarm the compressor will stop (regardless of status) and cannot be re-started until this state is reached.

6.3.1.3. The LOW temperature alarm is -5 °C (23°F), and to reset the alarm the temperature has to be above 10°C (50°F). In case of low temperature alarm, the compressor stops (regardless of status) and cannot be immediately restarted.

6.3.1.4. If the air-end temperature drops below -40°C (-40 °F) the temperature sensor will short circuit; in this case the compressor stops immediately regardless of its status and it is not possible to start it again.

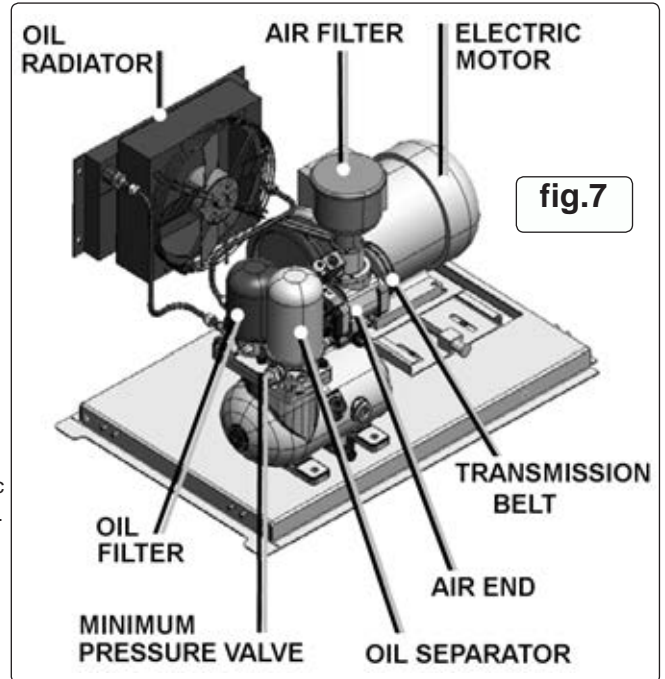

fig.7

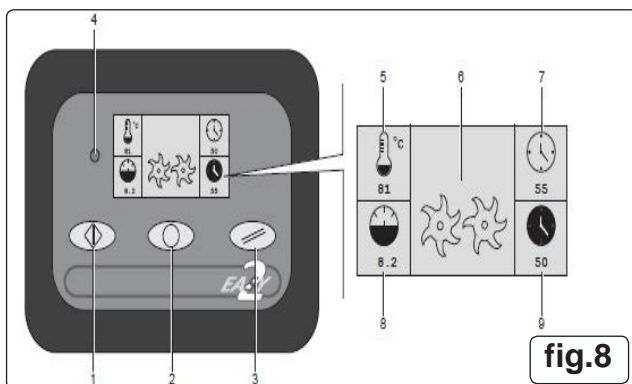

fig.8

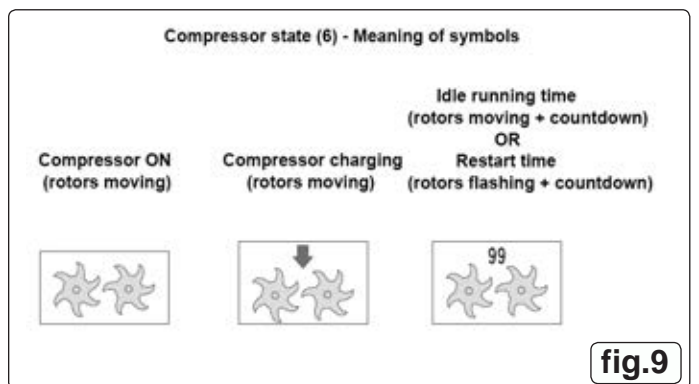





fig.9

Control Panel	Display
1 - START button	5 - Air-end delivery temperature
2 - STOP button	6 - Compressor state
3 - RESET button	7 - Working hours (total)
4 - Alarm LED	8 - Pressure
	9 - Working hours (duty)





6.3.2. **Remaining hours to maintenance (fig.10).**

Push button  for 5 seconds to see remaining hours to maintenance. If time to maintenance is already expired, a negative number will be shown (i.e. -3) alternately to the compressor status.

6.3.2. **User Menu - Setting(fig.11)**

Press button  and  together for at least 5 seconds to enter the Settings parameters Area. The Setting menus are accessible to different levels only by entering a password. Default password value is 111.

6.3.3. **To enter the password (111) (fig.11).**

Push  once (display shows 100) and confirm pressing 
 Push  once (display shows 110) and confirm pressing 
 Push  once (display shows 111) and confirm pressing 









6.3.4. **Minimum pressure setting (fig.12).**

Minimum = 5,5 bar / 80 psi - Maximum = 15 bar / 218 psi
 NOTE : display does not show decimal point.
 For example a reading of "055" shows 5,5 bar (as shown on the example).

6.3.5. **Maximum pressure setting (fig.13)**

Minimum = 6 bar / 87 psi - Maximum = 15,5 bar / 225 psi
 NOTE: display does not show decimal point.
 For example a reading of "100" shows 10,0 bar (as shown fig.13).

6.3.6. **To modify settings.**

- 6.3.6.1. Press  (value is flashing) :
- 6.3.6.2. Press buttons  and  to change values and  to confirm.
- 6.3.6.3. By pressing  you can confirm setting and move forward.
- 6.3.6.4. If you don't want to change the setting press  to move forward, or  to move backward.
- 6.3.6.5. At the end of the menus, display will show "OUT", press  to exit and go back to the compressor status.
NOTE: During the setting procedure, if any button is not pushed for 60 seconds, the control panel will exit automatically.

6.3.6.6. Check the rotation direction

The compressor is fitted with a phase sequence relay (KR). This points out the incorrect connection order of the power supply cables (relative to the three phases) that causes the incorrect rotation direction of the screw unit. In this event the compressor stops and the display shows the graphic shown in fig.14.

6.4. **Initial start up procedure.**

- WARNING! DO NOT** start the compressor with the doors open to avoid injury due to moving parts or electrically powered equipment.
 Before initially starting the compressor (or following extended inoperative periods), start the machine intermittently by pressing the START & STOP buttons on and off for 3 or 4 seconds. After this it is advisable to run the compressor for a few minutes with the air outlet tap open. Gradually shut-off the air tap and load to maximum pressure, checking if the inputs on each phase of the power supply are within the limits and also if the pressure switch trips. At this stage, when the max pressure value is achieved, the pressure switch will initiate idle running for 2 minutes. After this time, if there is no air consumption, the compressor will stay in the stand-by condition. Discharge the air from the tank until the starting pressure is reached (2bar difference compared to maximum pressure). Shut-off the air outlet tap and wait for the pressure switch to trip, which will shut-on the intake valve and close the internal discharge.

6.5. **Stopping the compressor in an emergency.**

Press the emergency stop button on control panel (see fig.14) to stop the compressor immediately.

6.6. **Manufacturer's calibration and settings.**

The minimum setting pressure is:

Mod/bar	set pressure
10	8

NOTE! By disconnecting the power supply from the external switch the compressor is completely without power.

The thermal relay is set according to the following parameters for the Star/Delta version:

Power HP: (10)
Rated voltage 380/415V: (7,5 A)

Disconnect the electrical power supply from the compressor before opening the electrical cabinet.

The setting of trip switch 1(fig.15) must not differ from the specification above; if the trip switch should trip, check the input of the motor of the compressor, the voltage on the line terminals L1+L2+L3 during operation and the power connections inside the electric control panel and of the terminal board of the motor and compressor.

- 6.6.1. For the correct operational performance of the machine under full continuous load at the maximum working pressure, ensure that the temperature of the work area in a closed room does not exceed +45°C. It is advisable to use the compressor with a maximum service of 80% in one hour under full load in order to ensure the correct efficiency of the product in time.

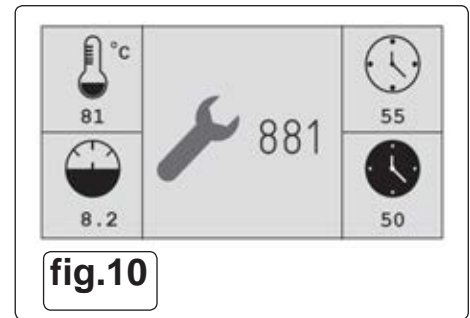

fig.10

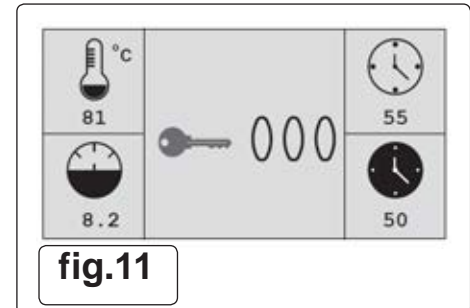

fig.11

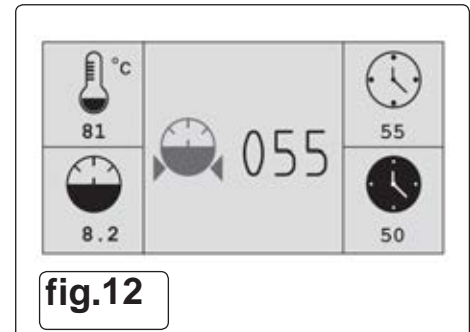

fig.12

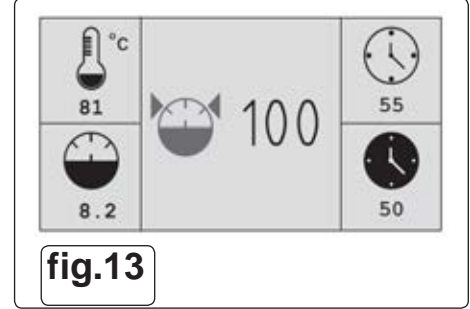

fig.13

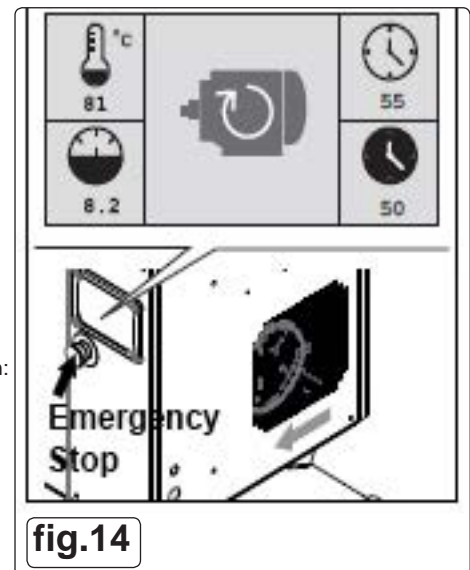

fig.14

7. USING THE DRYER - SSC12710D

7.1. Electrical Safety.

7.2. **IMPORTANT!** The dryer mains cable is supplied without a plug. Fit a UK 13Amp plug as described also to sections 1.1.1 to 1.1.5 in the compressor electrical safety section.

7.3. **WARNING!** It is the user's responsibility to check the following:

Check all electrical equipment and appliances to ensure that they are safe before using. Inspect power supply leads, plugs and all electrical connections for wear and damage. Sealey recommend that an RCD (Residual Current Device) is used with all electrical products. You may obtain an RCD by contacting your local Sealey stockist.

If the product is used in the course of business duties, it must be maintained in a safe condition and routinely PAT (Portable Appliance Test) tested.

Electrical safety information: it is important that the following information is read and understood.

7.3.1. Ensure that the insulation on all cables and on the appliance is safe before connecting it to the power supply.

7.3.2. Regularly inspect power supply cables and plugs for wear or damage and check all connections to ensure that they are secure.

7.3.3. **Important:** Ensure that the voltage rating on the appliance suits the power supply to be used and that the plug is fitted with the correct fuse - see fuse rating in these instructions.

× **DO NOT** pull or carry the appliance by the power cable.

× **DO NOT** pull the plug from the socket by the cable.

× **DO NOT** use worn or damaged cables, plugs or connectors. Ensure that any faulty item is repaired or replaced immediately by a qualified electrician.

7.3.4. This product is fitted with a BS1363/A 13 Amp 3 pin plug.

If the cable or plug is damaged during use, switch the electricity supply and remove from use.

Ensure that repairs are carried out by a qualified electrician.

Replace a damaged plug with a BS1363/A 13 Amp 3 pin plug. If in doubt contact a qualified electrician.

A) Connect the GREEN/YELLOW earth wire to the earth terminal 'E'.

B) Connect the BROWN live wire to the live terminal 'L'.

C) Connect the BLUE neutral wire to the neutral terminal 'N'.

Ensure that the cable outer sheath extends inside the cable restraint and that the restraint is tight.

Sealey recommend that repairs are carried out by a qualified electrician.

7.4. Preparing to use the dryer.

7.4.1. Functional description.

This compact drying system, having a refrigeration cycle, has been designed for the cost effective elimination of the condensate contained in compressed air by cooling it down to approximately +3°C. The operational principle of the dryer is shown in fig.16.

The air output is virtually humidity free, and the condensate collected in the separator is discharged through appropriate draining devices. Before exiting the dryer, treated air is counter current pre-heated by the air entering the system thus avoiding condensation on the external surfaces of the tubing and resulting in a more compact unit.

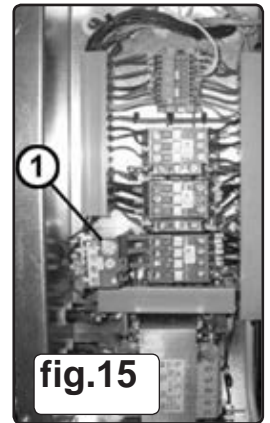
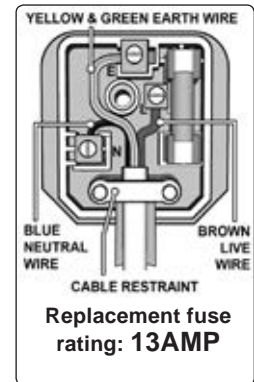

fig.15



Replacement fuse rating: 13AMP

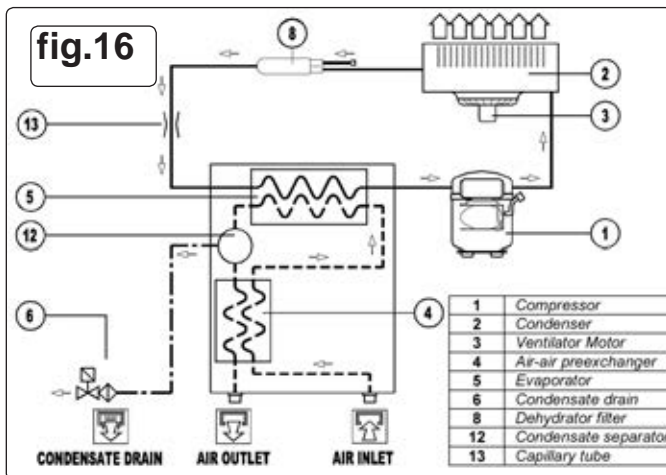

fig.16

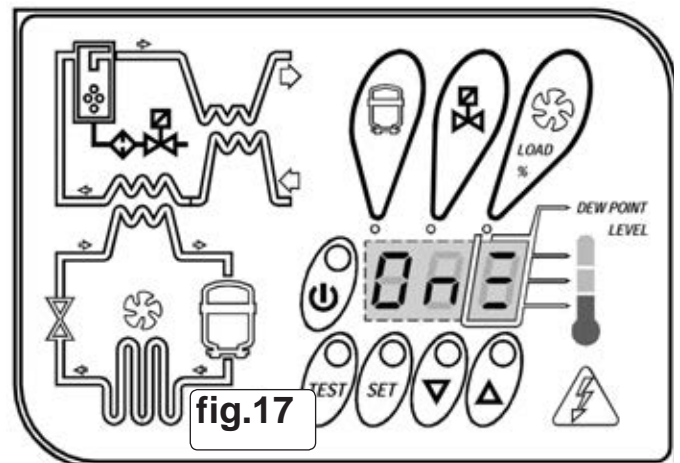

fig.17

7.4.2. The dryer comes provided with all necessary control, safety and adjustment devices, therefore no auxiliary devices are needed. A system overload not exceeding the maximum operative limits can worsen the operational performance of the dryer (e.g. high dew point), but it will not affect its safety. The user must provide the dryer with a line protection and a ground terminal.

7.4.3. Use of the machine in safe conditions

This system has been designed and manufactured in compliance with the European safety directive in force, therefore any installation, use and maintenance operations must be performed following the instructions contained in this manual. Any installation, use and maintenance operation requiring to access the internal parts of the dryer must be performed by qualified personnel. The manufacturer will not be liable in case of different uses or non-compliance with those detailed in this manual.

7.4.4. Control panel.

The dryer is provided with an electronic system for parameter modification. Reset operations can be performed by means of the digital control panel located on the front of the dryer. The control panel illustrated in fig.17 is composed of 5 keys (ON/OFF, TEST, SET, DOWN and UP) and a 3 digit display, with three signalling LEDs indicated by icons.

NOTE: when the controller is in OFF position, some parts of the system remain live. Therefore, for safety purposes, disconnect the electrical power before performing any operation on the machine.

7.4.5. **Condensate discharge parameters programming.**

Push the SET key for 10 seconds to enter the parameters configuration menu. The display will show in sequence the set point value, the code of the first modifiable parameter (C8 and its value). Only if strictly necessary, use the UP and/or DOWN keys to change the displayed parameter value. Press the SET key to store the previously changed parameter value or to browse the parameters without changing them. 15 seconds after the last performed operation, the controller will return automatically to the normal operation mode.

PARAMETER	DESCRIPTION	RANGE	SET VALUE
C8	Delay between condensate discharges	1 ÷ 999 (min)	1
C9	Time required for condensate discharge	1 ÷ 999 (sec)	1

NOTE: Changes entered for timing values will be effective only after exiting the programming, while changes to other variables will be immediately effective. Please remember that eventual changes to the configuration parameters of the machine could negatively affect its efficiency. Thus, changes have to be arranged in collaboration with the manufacturer.

❑ **WARNING!** It is forbidden to modify the other configuration parameters without the Service Centre's authorisation and collaboration.

7.4.6. **Anomaly/fault warning.**

The controller is capable of recognizing certain types of anomalies/faults occurring in the drying circuit. In such cases, an alarm message will blink on the display, alternated to the current dew – point value.

7.5. **REMOTE SIGNALLING ALARM.**

The dryer control board is equipped with a digital output for the remote signalling alarm. This digital output is controlled by a relay configured as normally open. When an alarm is detected, this relay loses a circuit. Proceed as follows to activate a remote alarm output:

7.5.1. The user must provide a signaller in compliance with output relays electrical features (solenoid coil, light bulb, acoustic signaller).

7.5.2. Disconnect the dryer from electrical power supply, remove cover and left side panel. Connect the signaller to the terminal blocks (See fig.18).

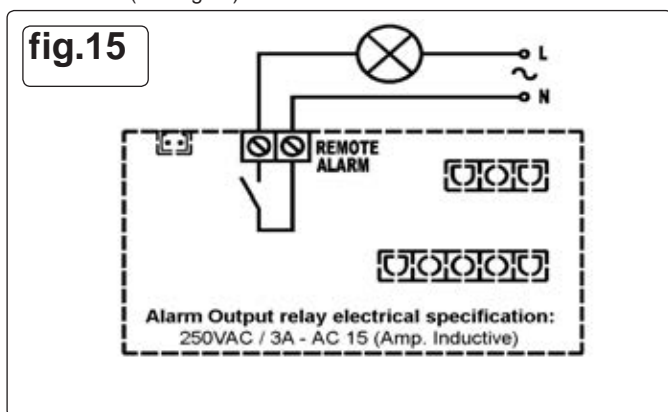

NOTE: The activation of the above function is at the user's discretion. The user must purchase all necessary installation material. Any operation which needs access to the dryer must be carried out by qualified personnel.

7.6. **Before dryer start up.**

Before starting the machine, make sure that all operating parameters correspond to the nominal data outlined in this instruction. The dryer is supplied already tested and preset for normal operation, and does not require any calibration. Nevertheless, it is necessary to check the operating performance during the first working hours.

7.7. **Dryer start up.**

7.7.1. The operations specified below must be performed after the first start up and at each start up after a prolonged inactive period of time due to maintenance operations, or any other reason.

7.7.2. Make sure that all instructions contained in chapters INSTALLATION SITE and INSTALLATION have been adhered to.

7.7.3. Check if by-pass is locked properly (if fitted).

7.7.4. Activate current supply and press the ON/OFF switch on the control panel for at least 1 second.

7.7.5. Wait 5 to 10 minutes until machine has achieved its standard operating parameters.

	This display means the unit is ON with low load.	
	This display means the unit is ON with normal load.	
	This display means the unit is ON with normal - high load.	
	This display means the unit is ON with high load.	
	LED Status - ON	Compressor energised
	LED Status 'Blinking'	Programming mode activated
	LED Status - ON	Condensate drain energised
	LED Status - ON	Speed of the fan = 100%
	LED Status 'Blinking'	Speed of the fan < 100%
	ON / OFF: Push for 3 seconds to switch ON or OFF. When the unit is OFF the display shows 'OFF'.	
	TEST - To activate a condensate drainage cycle, push for 3 seconds during normal operation.	
	SET - When pushed and released during normal operation it displays the set point value (decimal). When pushed for 10 seconds it gives access to the condensate drain parameters programming menu (C8 & C9). Having set new configuration values, push again to store them.	
	UP - When pushed whilst setting the set point or configuration values, it increases the displayed value by one unit per second, during the first 10 seconds then by 0.1 of a second thereafter.	
	DOWN - When pushed whilst setting the set point or configuration values, it decreases the displayed value by one unit per second, during the first 10 seconds then by 0.1 of a second thereafter. When pushed for ten seconds during normal operation, it starts an automatic test cycle of the controller.	

CODE	CAUSE	OUTPUTS	ACTIONS
HtA	High Dew – point value (delayed alarm).	Alarm output ON. Refrig. Compressor output OFF. Fan output ON. Discharge cycle standard.	Resettable by switching off the control board when dew-point returns to preset range. If it persists call our Service Centre.
Ht2	Very high Dew – point value (immediate alarm).		
LtA	Low Dew – point value.	Alarm output ON. Refrig. Compressor output OFF. Fan output OFF. Discharge cycle standard.	Automatic reset when dew-point returns to preset range. If it persists call our Service Centre.
PF1	Interruption or short circuit on the PTC probe input line.	Alarm output ON. Refrig. Compressor output OFF. Fan output OFF. Discharge cycle standard.	Resettable by switching off the control board and replacing the faulty probe. Call our Service Centre.
ESA	Energy saving mode activated.	Alarm output OFF. Refrig. Compressor output OFF. Fan output OFF. Discharge cycle standard.	No action necessary. Automatic Reset.
ES2			
ASt	Series of alarms very close to each other.	Alarm output ON. Refrig. Compressor output OFF. Fan output ON. Discharge cycle standard.	Call our Service Centre.

- 7.7.6. Slowly open the air outlet valve and successively open the air inlet valve.
- 7.7.7. If existent, close the by-pass.
- 7.7.8. Check if the condensate drainer is working properly. Check if all connecting pipes are properly tightened and fixed. Before disconnecting the dryer from electrical power supply, use ON/OFF key to stop the dryer. Wait 10 minutes before switching the dryer on again, in order to allow freon pressure re-balance.
- 7.8. Dryer Maintenance.**
Before attempting any maintenance operation, make sure that:
- No part of the system is under pressure.
 - No part of the system is electrically powered.
- 7.8.1. **Weekly or every 40 hours of operation.**
Verify the temperature on the control panel display.
Visually check if the condensate is drained.
- 7.8.2. **Monthly or every 200 hours of operation**
Clean the condenser with a compressed air jet, taking care not to damage the cooling battery aluminium wings.
At the end of the above mentioned operations, check if the dryer is working properly.
- 7.8.3. **Yearly or every 2000 hours of operation**
Check if the flexible tube used for condensate drainage is damaged and replace it if necessary.
Check if all connecting pipes are properly tightened and fixed.
At the end of the above mentioned operations, check if the dryer is working properly.
- 7.8.4. **Troubleshooting.**
NOTE: following conditions are normal characteristics of operation and not faults:
- Variable speed of the fan.
 - Visualization of message ESA in case of operation without load.
 - Visualization of negatives values in case of operation without load.
- Troubleshooting and eventual control and/or maintenance operations must be performed by qualified personnel.
For maintaining the refrigerating circuit of the machine, contact a refrigeration engineer.
IMPORTANT: The temperature control probe is extremely delicate. **DO NOT** remove the probe from its position. In case of any faults, please contact your Service Centre.

TROUBLESHOOTING	
PROBLEM	POSSIBLE CAUSE AND REMEDY
• Luminous switch / Control panel display OFF.	1. Check if the line is electrically powered. 2. Check cabling. 3. Check the electronic control board; if the trouble persists, replace it.
• The compressor will not start.	1. Check cabling and control. 2. Activation of compressor's internal thermal protection; wait one hour and check again. If the fault persists: stop dryer and call a refrigeration engineer. 3. Check the compressor's electrical components. 4. Short circuit in the compressor. Replace it.
• The fan doesn't work.	1. Check the protection fuse (if present), and replace it if necessary. 2. Check cabling. 3. Check the electronic control board; if the trouble persists, replace it. 4. Short circuit in the fan. Replace it.
• Condensate drain absent (no water or air).	1. Check cabling. 2. Drainage system pre-filter is dirty, clean it. 3. Drainage solenoid valve coil is burnt out, replace it. 4. Drainage solenoid valve clogged/jammed, clean or replace it. (fig.13) 5. Check the electronic card, if the trouble persists, replace it. 6. The temperature on the display of the control panel is lower than the nominal value, call a refrigeration engineer.
• Air flows continuously through the condensate drainage.	1. Drainage solenoid valve jammed, clean or replace it. (fig.13) 2. Verify the condensate drainage times. 3. Check the control. If the trouble persists, replace it.
• Water in the pipes downstream of the dryer.	1. The dryer is off; turn it on. 2. Close by-pass (if present). 3. Condensate drainage absent; see specific section. 4. The temperature on the control panel display is higher than the nominal value; see specific section.
• The temperature on the control panel display is higher than the nominal value.	1. Check if the compressed air inlet/outlet is connected properly. 2. The compressor doesn't start; see specific section. 3. The fan doesn't turn; see specific section. 4. The flow rate and/or temperature of the air entering the dryer are higher than the nominal values; restore the nominal conditions. 5. The ambient temperature is higher than the nominal values; restore the nominal conditions. 6. The condenser is dirty; clean it. 7. Condensate drain absent (no water nor air); see specific section. 8. Check if the temperature control probe in the evaporator is positioned improperly or faulty. 9. Gas leakage in the refrigerating circuit: stop dryer and call a refrigeration engineer. 10. Check cabling.
• The dryer does not let compressed air flow through.	1. Check if the compressed air inlet/outlet is connected properly. 2. The temperature on the control panel display is lower than the nominal value; call a refrigeration engineer. 3. Check if the temperature control probe in the evaporator is positioned improperly or faulty. 4. Check if the connecting tubing is clogged. 5. Check if by-pass (if present) is installed properly. 6. Check electronic control board. If the trouble persists, replace it.

Interval (hours)	TASKS TO BE PERFORMED	See section
Weekly	Check if the filters of the electric cabinet are clogged	
	Check if the anti-dust pre-filter is clogged	7.8
	Drain condensate on a weekly basis.	
500 hours after first start	Change oil and oil filter.	7.2 & 7.3
	Check the electrical connections and tighten if necessary	
every 2500 hours or at least every year	Replace the oil filter cartridge	7.3
	Replace the oil separator filter cartridge	7.4
	Replace the air filter cartridge	7.5
	Check the transmission	7.6
	Clean the air/oil radiator.	7.9
	Check filters in electrical cabinet and replace if necessary	
	Clean inverter dissipator (if equipped)	
	Check the safety valve	
	Check the electrical connections and tighten if necessary	
	Change oil	7.2
	every 7500 hours	Check the hydraulic seals
Overhaul the suction valve		
every 12500 hours	Check the hoses and replace if necessary	
	Overhaul oil separator flange	
	Grease the minimum pressure valve	
	Replace Fluorflon pipes 6x4 and 10x10	
	Replace the screw oil seal	
	Replace the screw oil seal	
	Replace the bearings of the radiator fan motor (to be done by service centre).	
	Replace the delivery OR flange	
	Clean the compressor externally when not in use	
every 20000 hours	Replace inverter fan (if equipped)	
	Replace the bearings of the screw (to be done by Technical Service centre)	

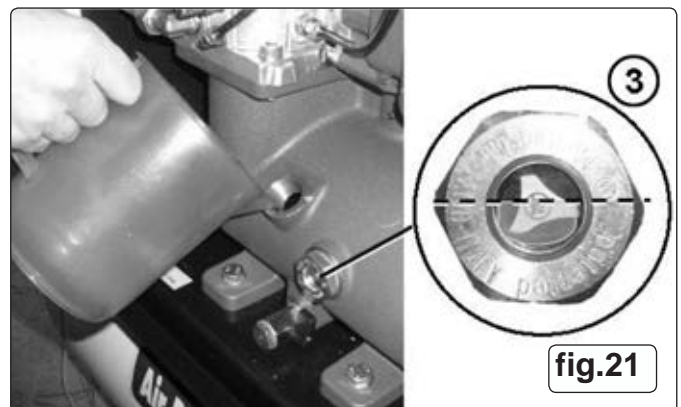
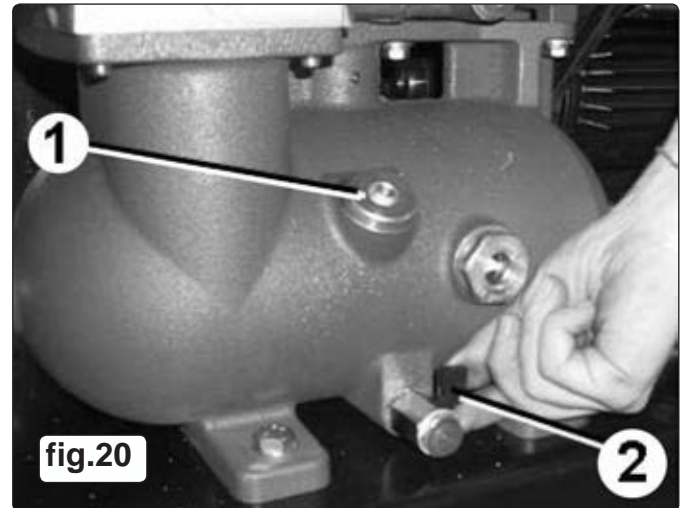
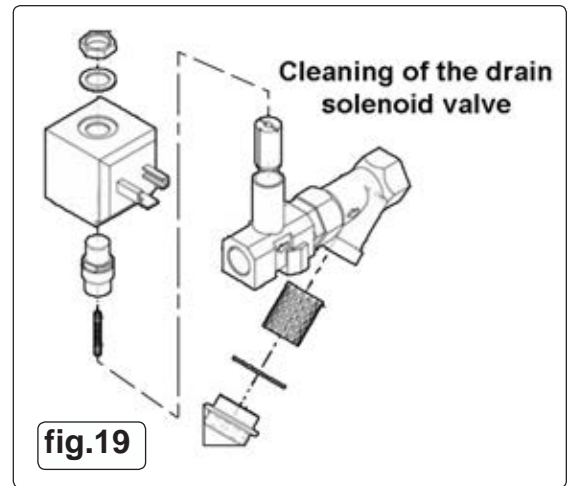

- The above maintenance schedule requires that the user has adhered to all the installation parameters and usage laid out in this manual.
- The customer is also advised to keep a record of all maintenance jobs performed on the compressor.

7.9. Changing the oil.

- 7.9.1. Change the oil following the initial **500 hours** of use and then every **2500 hours** thereafter, or at least once a year. In case of infrequent use (only a few hours of duty per day) you should change the oil every 6 months. Referring to fig.20 identify the oil filler cap (1) and the oil drain tap (2). Unscrew the oil filler cap (1) and put to one side. Ensure that the oil drain tap is shut off (i.e. tap handle at 90° to the body of the tap). Have to hand a pipe and container ready to collect the oil.
- 7.9.2. Unscrew the hex nut from the end of the oil drain tap. Screw in the tail piece attachment supplied with the compressor. Push the pipe onto the tailpiece and ensure that the other end is in the collection container. Open the drain tap fig.20-2. Once emptied, close tap, remove the tail piece attachment and screw the hex nut (with seal) back into place.
- 7.9.3. Fill-up with oil as shown in fig.21 until the level is halfway up the sight glass. See fig.21-3. Screw oil filler cap (1), with its seal, back into the oil filler hole.
- 7.9.4. Once the oil and oil filter have been changed follow the initial start up procedure by pressing the START & STOP buttons on and off for 3 or 4 seconds to start the machine intermittently. After this, leave the compressor to run for roughly 5 minutes then turn it off and check the oil level again. Check the oil level once a month.
- 7.9.5. Never mix different types of oil, therefore always ensure that the circuit is completely empty before filling-up with oil. Each time the oil is changed the filter is also to be replaced.

Recommended oil.

Mineral oil : Grade 46st

Part No.	Qty.	Description
SCPO1S	1ltr	Mineral oil.
SCPO5	5ltr	Mineral oil.

7.10. Replacing the oil filter.

- 7.10.1. Replace the oil filter after the first **500 hours** of use then every **2500/3000 hours** and in any event, each time the oil is changed. Refer to fig.22.
- 7.10.2. Loosen and remove the four bolts retaining the front panel using a 3mm hex key. Lift off the panel and put to one side.
- 7.10.3. Loosen the oil filter using a suitable wrench. Unscrew the filter and lift off. Lubricate the sealing gasket on the new filter and screw into place. Once the sealing gasket has made contact with the housing tighten a further $\frac{3}{4}$ of a turn. Refit cabinet front panel.

7.11. Replacing the oil separator filter.

- 7.11.1. Refer to fig.22. Loosen and remove the four bolts retaining the front panel using a 3mm hex key. Lift off the panel and put to one side.
- 7.11.2. Loosen the oil separator filter using a suitable wrench. Unscrew the filter and lift off. Lubricate the sealing gasket on the new filter and screw into place. Once the sealing gasket has made contact with the housing tighten a further $\frac{3}{4}$ of a turn. Refit cabinet front panel.

7.12. Replacing the air filter cartridge.

- 7.12.1. Referring to fig.22. Loosen and remove the four bolts retaining the front panel using a 3mm hex key. Lift off the panel and put to one side.
- 7.12.2. Turn the top of the filter housing anti-clockwise and lift off. Lift out the old air filter, clean out the air filter housing and replace the air filter with a new one. Ensure the new filter is correctly seated within the housing. Place the top of the filter housing onto the housing itself in the same orientation that it was removed and turn clockwise to lock in place. See fig.23. Refit cabinet front panel.

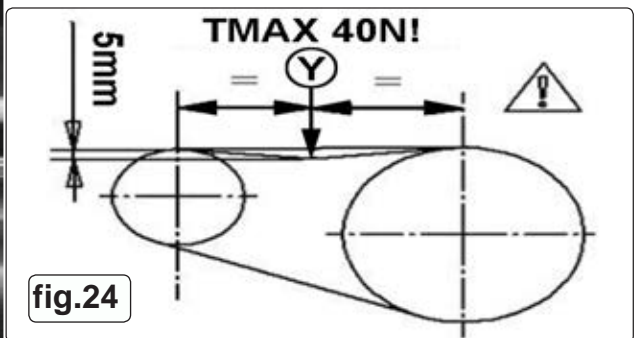
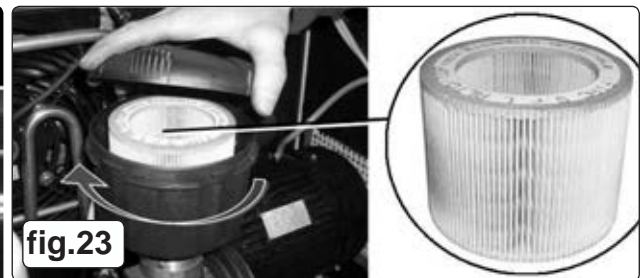
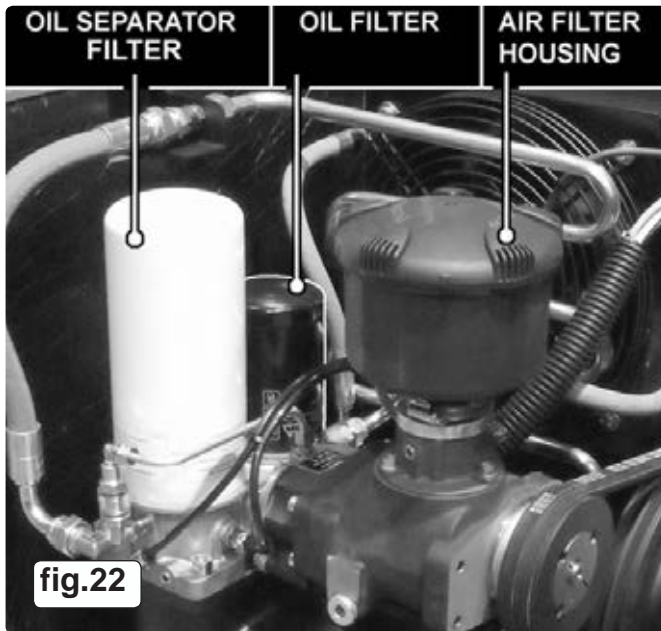

7.13. Checking drive belt tension

- 7.13.1. Every **500 hours** of use it is advisable to check and if necessary tighten the belt.
- 7.13.2. Loosen and remove the four bolts retaining the front panel using a 3mm hex key. Lift off the panel and put to one side.
- 7.13.3. Using a dynamo meter apply a perpendicular force at point 'Y' of between 25N and 35N (see fig.24).
- 7.13.4. The belt must give by roughly 5mm. Refer to fig.25, turn the nut 'A' to tighten the belt. Apply a maximum force 40N. An excessive force could damage the bearings in both the motor and the screw unit!
- 7.14. Replacing the drive belt.
- 7.14.1. Loosen and remove the four bolts retaining the front panel using a 3mm hex key. Lift off the panel and put to one side.
- 7.14.2. Referring to fig.19, turn the nut 'A' to slacken the belt. Slide the belt out, replace it with a new one and tighten as described in the previous section.

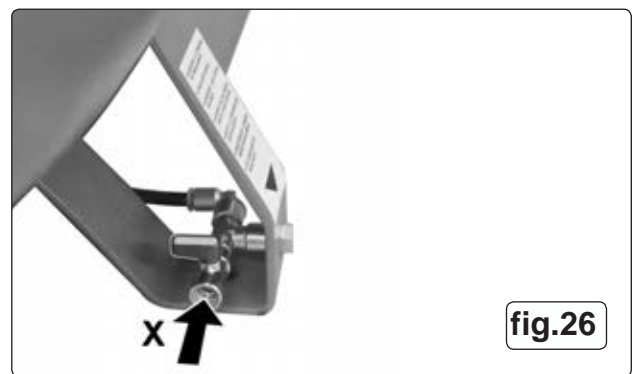
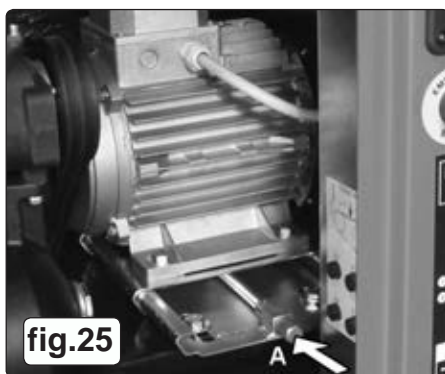

7.15. Draining the condensate.

- 7.15.1. Drain the condensate from the air tank on a weekly basis using the tap outlet secured to the foot of the tank. See fig.26. Attach a suitable tailpiece and drainage tube to thread 'X'. Direct the tube into a suitable container and open the drainage tap.
- 7.15.2. The condensate drained is considered as a polluting mix that must be disposed of according to local authority regulations. Ideally the condensate should be passed through special water/oil separators prior to disposal.

7.16. Cleaning the air/oil radiator.

Clean the radiator on a weekly basis to remove dust and impurities. Using a compressed air gun on a low pressure setting, blow from inside outwards making sure that no dirt settles inside the compressor. See fig.21.

7.17. Electric motor maintenance.

The bearings of the electric motor are pre-lubricated and are maintenance free. In normal conditions (ambient temperature up to 30°C) replace the motor bearings after every **12500 hours** of use. In more adverse conditions ambient temperature up to 40°C) replace the motor bearings after every **8000 hours** of use. The bearings must be replaced in any event after every 4 years.

7.18. Diagnosing the alarm CODE status/anomalies/faults.

Before doing any job on the compressor ensure that:

- The main ON/OFF switch is turned to the OFF position (“0”)
- The EMERGENCY/STOP button is pressed down into the security position.
- The compressor is shut-off from the compressed air system.
- The compressor and the internal pneumatic circuit are completely de-pressurised.

If you are unable to rectify the anomaly encountered on your compressor contact your nearest authorised service centre.

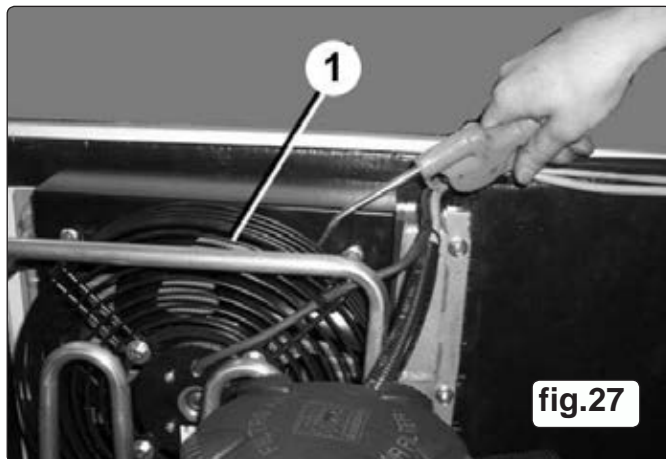

ALARM CODE CONDITIONS

Alarm code.	Problem	Causes	Solutions
AL0	Machine stopped – temperature probe anomalies.	Damage of temperature probe or electric cable.	Disconnect from the main power, replace the temperature probe and check the cables. To restart the compressor press the RESET button on the main board.
AL1	The machine stops, as the oil alarm has triggered.	Excessive temperature of air/ oil mix outlet from the screw (105°C).	Check the oil level. Check if the radiator is clean. To restart the compressor press the RESET key on the main board.
AL2	Machine stopped: low temperature thermostat tripped.	Ambient temperature below 0°C.	To start the machine again ensure the compressor installation environment guarantees a minimum ambient temperature above - 5°C. To restart the compressor press the RESET button on the main board.
AL3	Machine stopped: the compressor will not start.	Emergency button pressed.	Turn the emergency button clockwise to unlock it. Press the reset button on the control panel.
		Wrong rotation direction.	Switch off power to the compressor and reverse two phases of the power cable on the terminals for connection of the cable line.
AL4	Machine stopped- motor thermal protection switch tripped.	The thermal protection switch of the motor has tripped.	Check if the electrical power supply is correct, check if the three power supply phases are more or less at the same value. Check if the cables are firmly fitted to the terminal board. Check if the electrical cables have melted. Check if the fan in-take grill is clean or obstructed in some way. (paper, leaves, rags). To restart the compressor press the RESET key on the main board.
	Machine stopped: temperature thermostat tripped.	The internal thermal protection switch of the fan motor has tripped.	Check if the electrical power supply is correct, check if the three power supply phases are more or less at the same value. Check if the cables are firmly fitted to the terminal board, check if the electrical cables have melted. Check if the fan intake grill is clean or obstructed in some way. (paper, leaves, rags). To restart the compressor press the RESET key on the main board.
	Compressor is running but fails to load.	The suction valve has failed to open	Check if the pressure probe is working correctly and also if the commanding solenoid valve (NC solenoid valve) is working regularly.
AL5	Control panel internal malfunction.		
AL6	Maintenance required.		



WEEE REGULATIONS

Dispose of this product at the end of its working life in compliance with the EU Directive on Waste Electrical and Electronic Equipment (WEEE). When the product is no longer required, it must be disposed of in an environmentally protective way. Contact your local solid waste authority for recycling information.



ENVIRONMENT PROTECTION

Recycle unwanted materials instead of disposing of them as waste. All tools, accessories and packaging should be sorted, taken to a recycling centre and disposed of in a manner which is compatible with the environment. When the product becomes completely unserviceable and requires disposal, drain any fluids (if applicable) into approved containers and dispose of the product and fluids according to local regulations.

Note: It is our policy to continually improve products and as such we reserve the right to alter data, specifications and component parts without prior notice.

Important: No Liability is accepted for incorrect use of this product.

Warranty: Guarantee is 12 months from purchase date, proof of which is required for any claim.

Sealey Group, Kempson Way, Suffolk Business Park, Bury St Edmunds, Suffolk. IP32 7AR



01284 757500



01284 703534



sales@sealey.co.uk



www.sealey.co.uk