



INSTRUCTIONS FOR  
**MODULAR STORAGE SYSTEM - SUPERLINE PRO**  
 MODEL NO: **APMS SERIES**

Thank you for purchasing a Sealey product. Manufactured to a high standard, this product will, if used according to these instructions, and properly maintained, give you years of trouble free performance.

**IMPORTANT:** PLEASE READ THESE INSTRUCTIONS CAREFULLY. NOTE THE SAFE OPERATIONAL REQUIREMENTS, WARNINGS & CAUTIONS. USE THE PRODUCT CORRECTLY AND WITH CARE FOR THE PURPOSE FOR WHICH IT IS INTENDED. FAILURE TO DO SO MAY CAUSE DAMAGE AND/OR PERSONAL INJURY AND WILL INVALIDATE THE WARRANTY. KEEP THESE INSTRUCTIONS SAFE FOR FUTURE USE.



Refer to instruction manual



Wear protective gloves

### 1. SAFETY

- WARNING!** Ensure Health & Safety, local authority, and general workshop practice regulations are adhered to when using this storage system.
- ✓ Locate in a suitable work area.
- ✓ Keep the work area clean, uncluttered and ensure there is adequate lighting.
- WARNING!** Use storage on level and solid ground, preferably concrete.
- ✓ Keep the storage system clean and tidy in accordance with good workshop practice.
- ✓ Keep children and unauthorised persons away from the work area.
- x **DO NOT** use the storage system for any purpose other than that for which it is designed.
- x **DO NOT** use the storage system outdoors.
- x **DO NOT** place the storage system in a damp or wet location or an area where there is condensation.
- x **DO NOT** clean the storage system with any solvents which may damage the surfaces or the protective coating.
- x **DO NOT** move the storage system when there are items placed inside.
- x **DO NOT** step on the shelves.
- x **DO NOT** overload the storage system.

### 2. INTRODUCTION

Modular storage system ideal for any garage/workshop. Durable construction that will last for years. Easily adjusts to specific needs. Purchase a simple base cabinet or create a full workshop storage system.

### 3. SPECIFICATION

Model no: ..... **APMS50UCS Upright Connector Single**  
 Size W x D x H: ..... 32.5 x 30 x 1420mm

Model no: ..... **APMS50UCD Upright Connector Double**  
 Size W x D x H: ..... 65 x 30 x 1420mm

Model no: ..... **APMS50BP Back Panel**  
 Size W x D x H: ..... 615 x 24 x 1052mm  
 Hole dimensions: ..... 9.1 x 9.1mm  
 Hole distance: ..... 29mm

Model no: ..... **APMS52 2 Door Floor Cabinet 680mm**  
 Size W x D x H: ..... 680 x 458 x 910mm

Model no: ..... **APMS53 Wall Cabinet 680mm**  
 Size W x D x H: ..... 680 x 281 x 350mm

Model no: ... **APMS54 Wall Cabinet Tambour Front 680mm**  
 Size W x D x H: ..... 680 x 281 x 350mm

Model no: ..... **APMS57 Cabinet Multi-function 680mm**  
 Size W x D x H: ..... 680 x 458 x 910mm

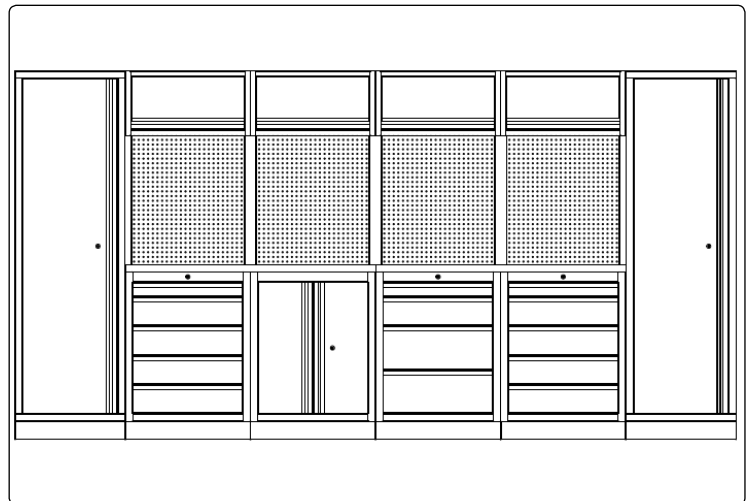

## 4. ASSEMBLY

### Step 1

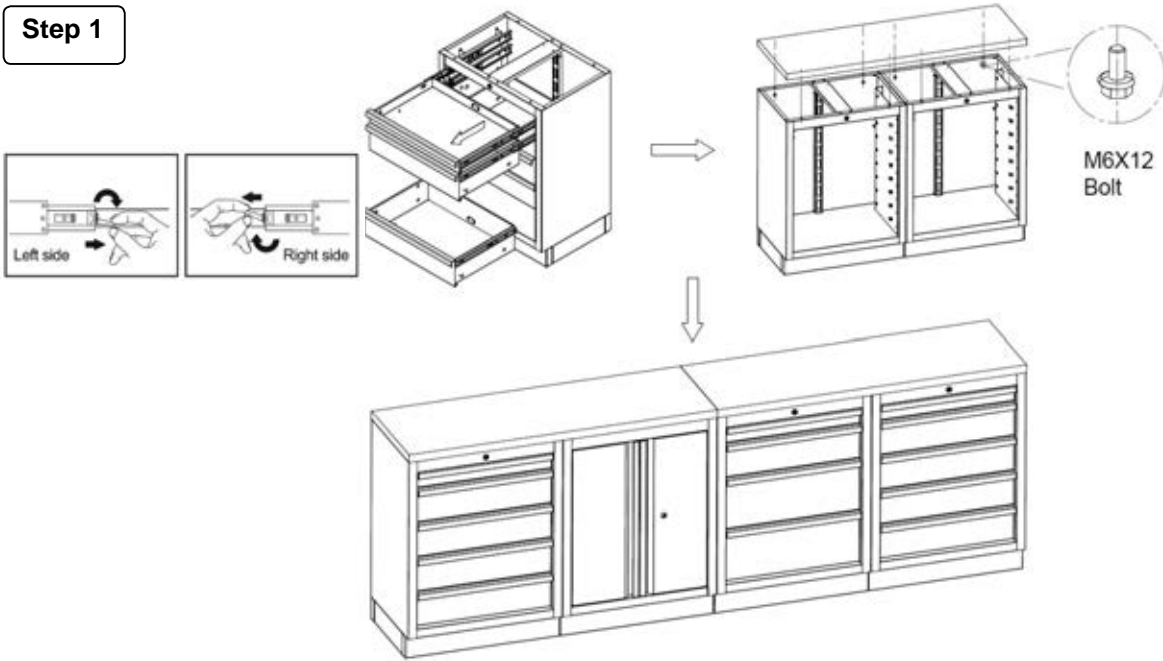

### Step 2

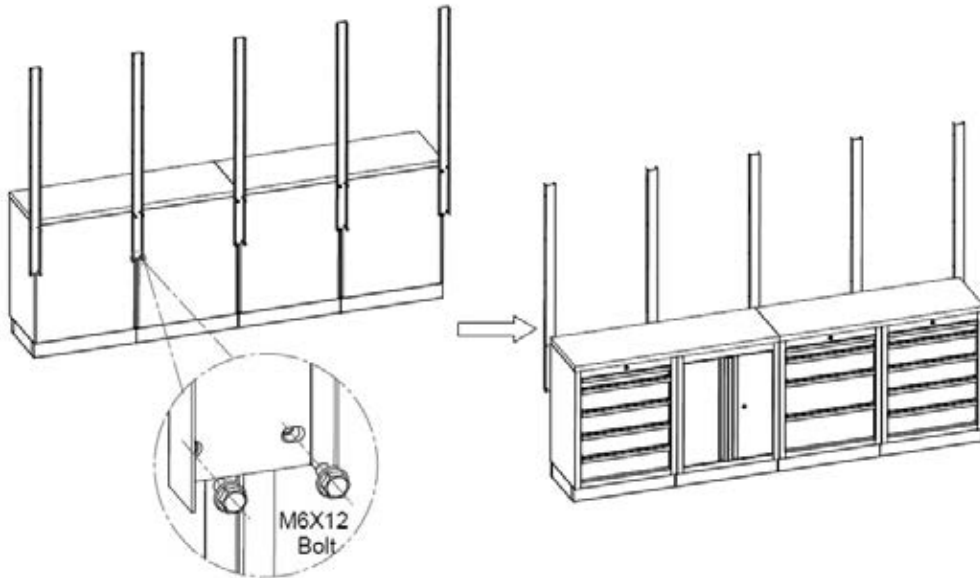

### Step 3

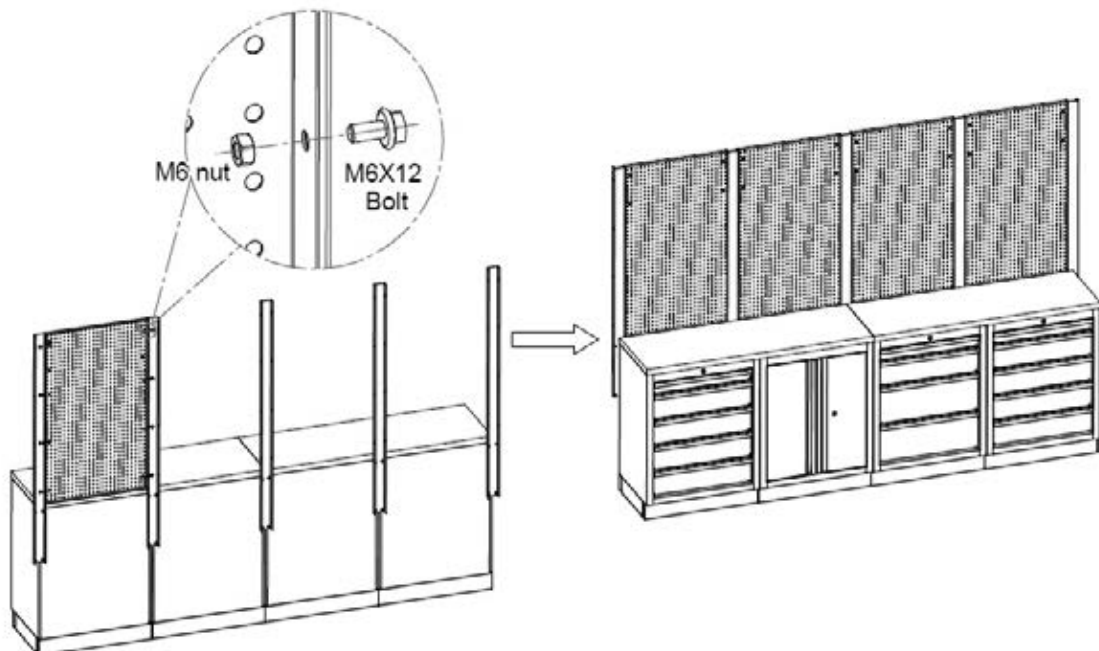

**Step 4**

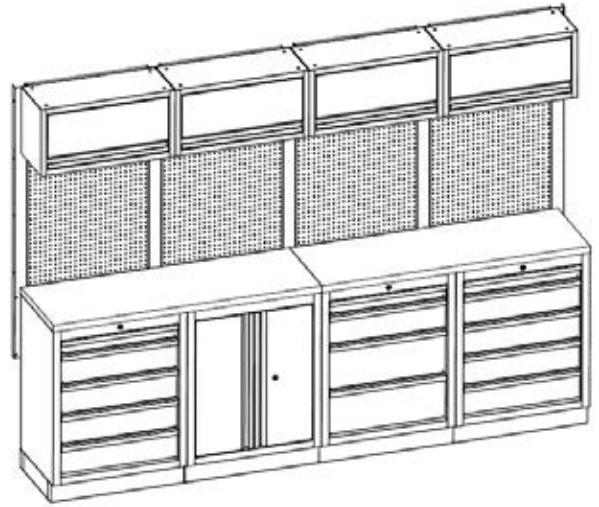
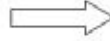
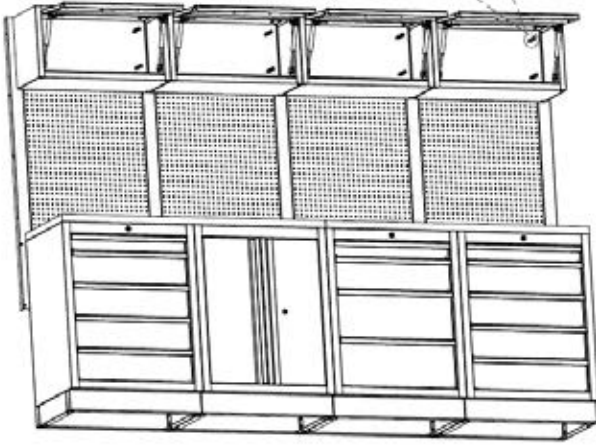
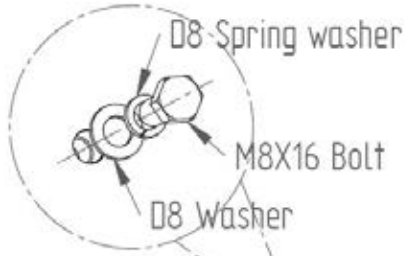

**Step 5**

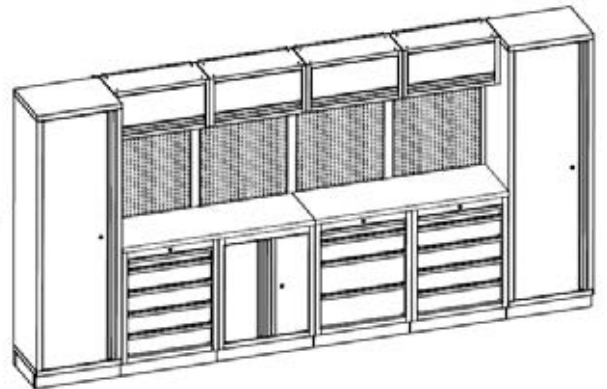
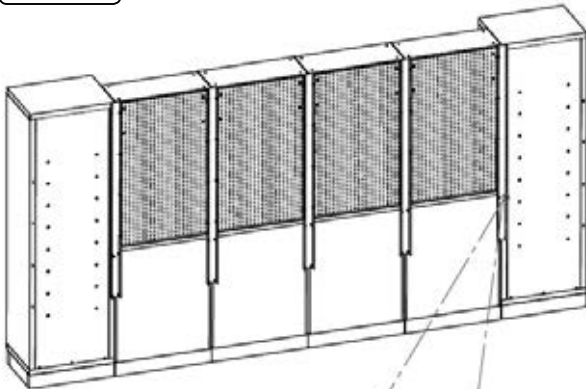

**ENVIRONMENT PROTECTION**

Recycle unwanted materials instead of disposing of them as waste. All tools, accessories and packaging should be sorted, taken to a recycling centre and disposed of in a manner which is compatible with the environment. When the product becomes completely unserviceable and requires disposal, drain any fluids (if applicable) into approved containers and dispose of the product and fluids according to local regulations.

**Note:** It is our policy to continually improve products and as such we reserve the right to alter data, specifications and component parts without prior notice.

**Important:** No Liability is accepted for incorrect use of this product.

**Warranty:** Guarantee is 12 months from purchase date, proof of which is required for any claim.

**Sealey Group, Kempson Way, Suffolk Business Park, Bury St Edmunds, Suffolk. IP32 7AR**



**01284 757500**



**01284 703534**



**sales@sealey.co.uk**



**www.sealey.co.uk**