

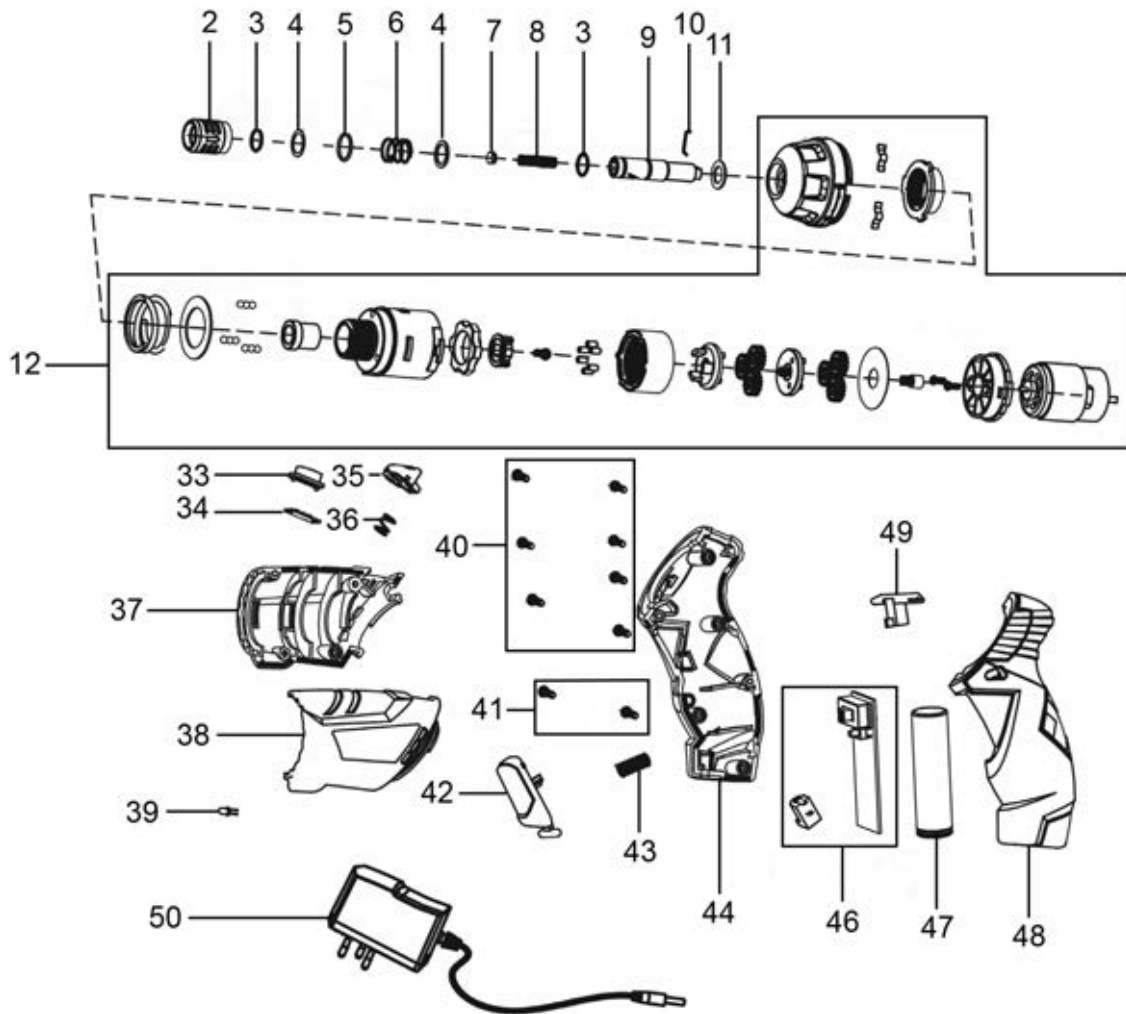

Parts Information:
Cordless Screwdriver Set 26pc 3.6V
Lithium-ion
Model No: CP36B.V2



Item	Part No.	Description
2	CP36B.02	Bushing
3	CP36B.03	C-Ring
4	CP36B.04	Washer
5	CP36B.05	C-Ring
6	CP36B.06	Spring
7	CP36B.07	Rubber Bushing
8	CP36B.08	Spring, Output Shaft
9	CP36B.09	Output Shaft
10	CP36B.10	Wire Clasp
11	CP36B.11	Washer, Output Shaft
12	CP36B.12-32	Gearbox & Motor Assembly
33	CP36B.33	Cover, Battery Indicator
34	CP36B.34	PCB, Battery Indicator
35	CP36B.35	Rotation Button
36	CP36B.36	Spring, Rotation Button

Item	Part No.	Description
37	CP36B.37	Housing Support
38	CP36B.38	Housing Cover
39	CP36B.39	Led
40	CP36B.40	Self Tapping Screw ST2.5 x 12mm
41	CP36B.41	Self Tapping Screw ST2.5 x 8mm
42	CP36B.42	Button, Switch
43	CP36B.43	Spring, Switch
44	CP36B.44	Side Handle, Right
46	CP36B.46	PCB Assembly
47	CP36B.47	Battery
48	CP36B.48	Side Handle, Left
49	CP36B.49	Button, Forward/Reverse
50	CP36S.V4-57	Mains Charger 7.5V 1000mA
--	CP36B.01	Bit (Not Shown)

NOTE: It is our policy to continually improve products and as such we reserve the right to alter data, specifications and component parts without prior notice. There may be alternative versions of this product, please contact us should you require this information.

IMPORTANT: No liability is accepted for incorrect use of product. Spare parts must be fitted by a competent person

WARRANTY: Guarantee is 12 months from purchase date, proof of which will be required for any claim.

Sealey Group, Kempson Way, Suffolk Business Park, Bury St Edmunds, Suffolk. IP32 7AR



01284 757500



01284 703534



sales@sealey.co.uk



www.sealey.co.uk