

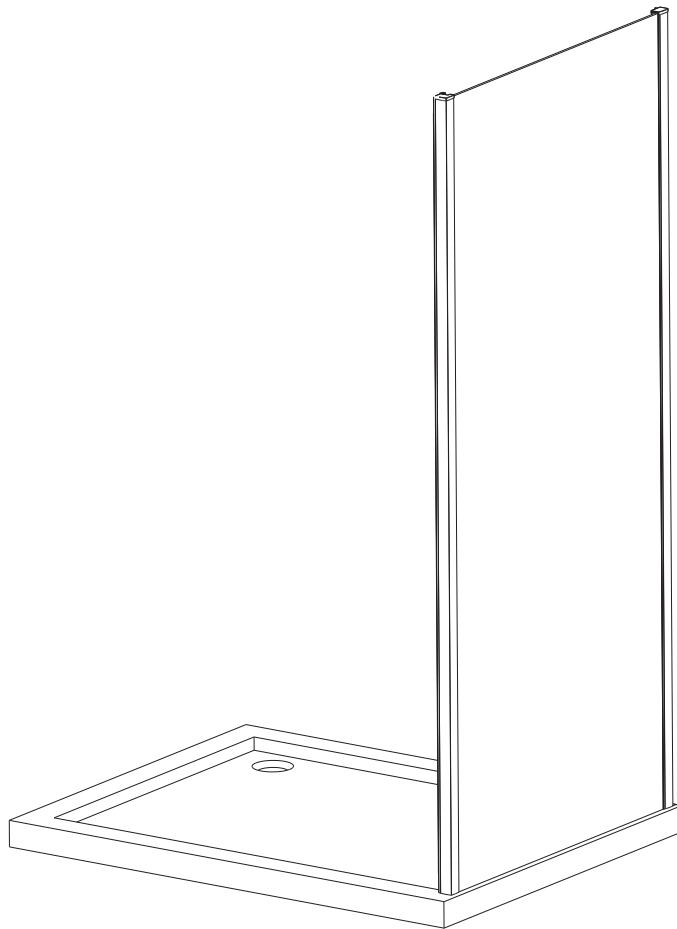



# 6mm SIDE PANEL GUIDE



## General Information

Please inspect this product upon delivery. Any missing parts or manufacturing defects must be reported immediately to the supplier. Damage or defects reported later will not be accepted. TAKE CARE WHEN HANDLING GLASS PARTS-AVOID HEAVY CONTACT BETWEEN THE GLASS EDGES AND ANY HARD SURFACE. Glass breakage claims will not be accepted after the product has been unpacked.

## TOOLS REQUIRED

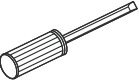
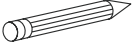
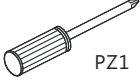
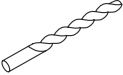
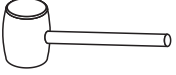
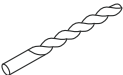
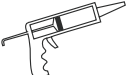
| DESCRIPTION    | PART IMAGE   | DESCRIPTION            | PART IMAGE   |
|----------------|--|------------------------|--|
| Tape measure   |   | Drill                  |         |
| Spirit level   |   | Flat-head Screwdriver  |         |
| Pencil         |   | Cross head Screwdriver | <br>PZ1 |
| Ø6mm Drill bit |   | Mallet                 |         |
| Ø3mm Drill bit |  | Silicone Sealant       |        |

 This product is heavy and may require two people to install.

## ASSEMBLY INSTRUCTIONS - DRAWING

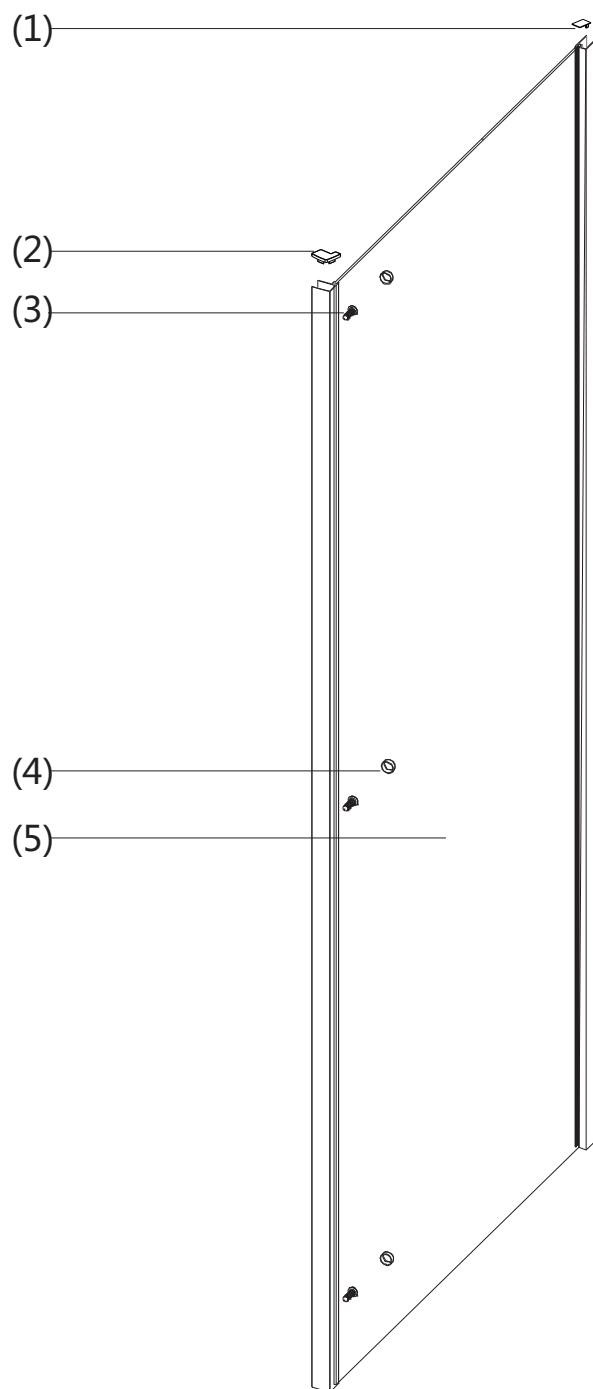

- (1) 1x Cover Cap For Upright Profile
- (2) 2x Corner Post Profile Cover L/R
- (3) 3x Corner Profile Screw ST4x16
- (4) 3x Screw Cap
- (5) 1x Fixed Panel

## Before Installation

Please ensure that the shower tray is level and checked with a spirit level.  
The tray should be installed first. Tiles should then be tiled down to the tray.  
The enclosure can then be installed.

### Step 1 DRILLING WALL PROFILE TO THE WALL

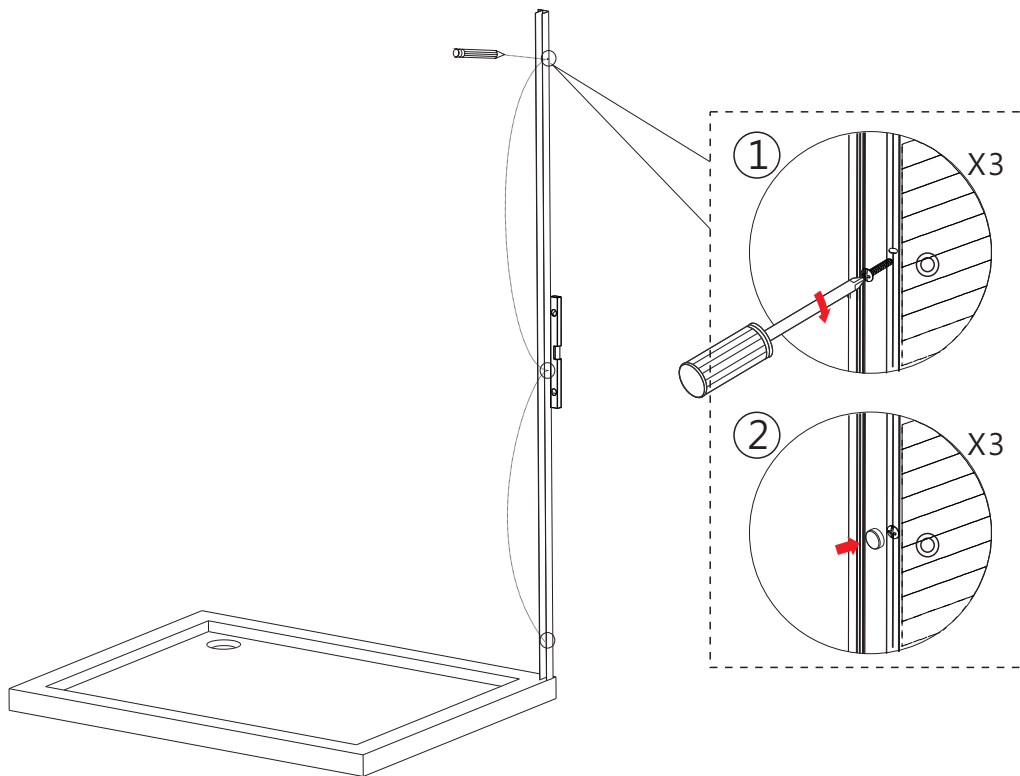

### Step 2

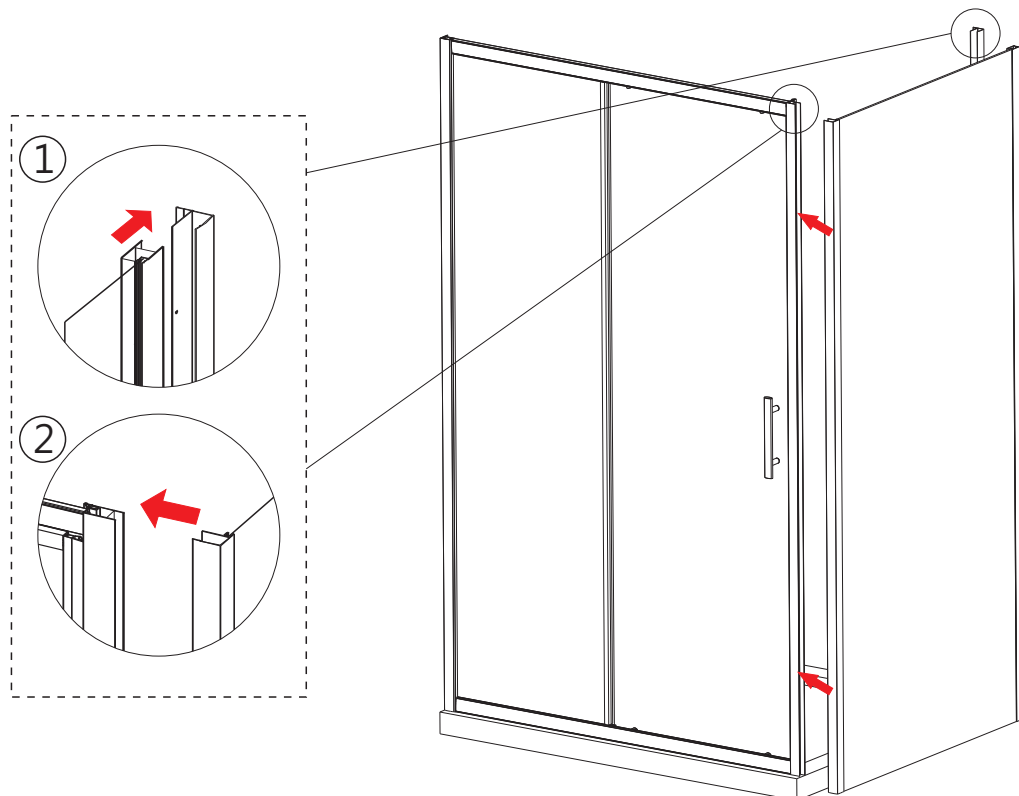

## Step 3

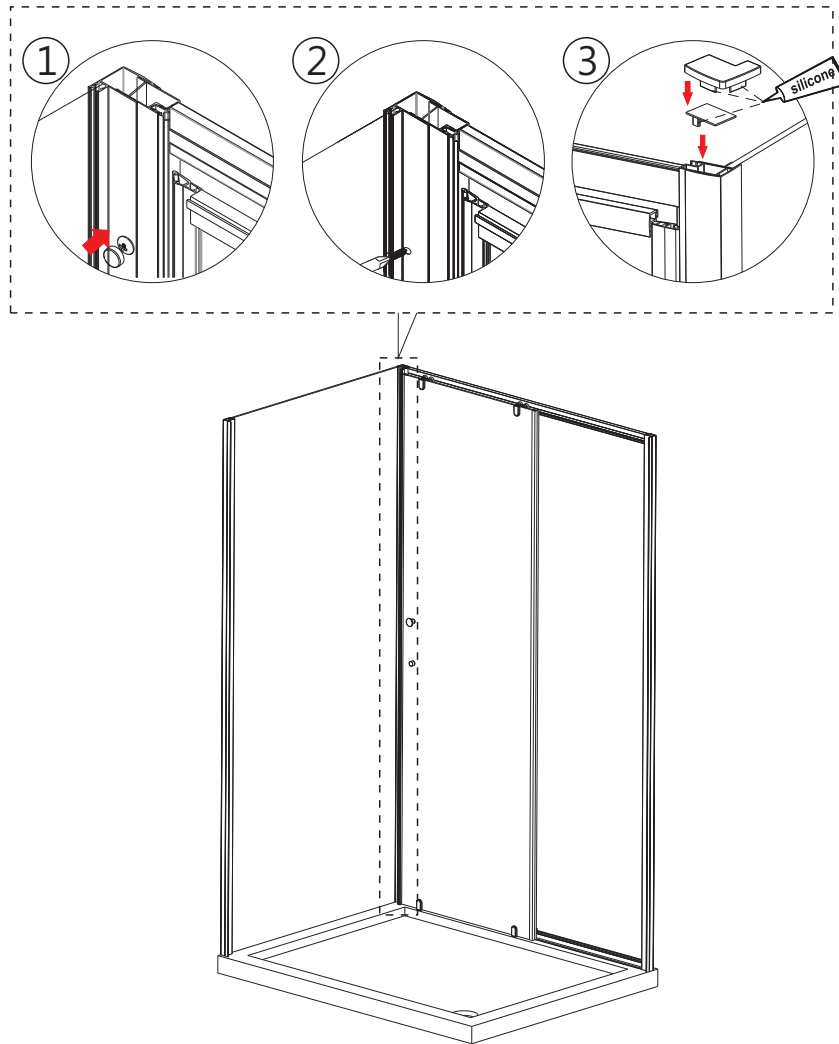

## Step 4

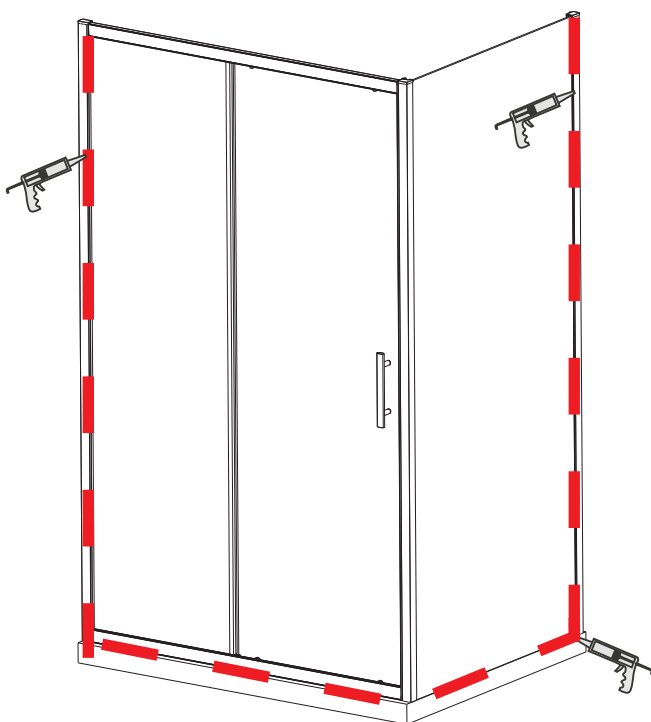

**Allow 24 hours for silicone to dry before use. Silicone on the outside edge only, NOT THE INSIDE**

### Aftercare instructions

Regularly clean your shower product with warm soapy water to prevent lime scale build up. **DO NOT** use abrasive cleaning fluids or materials, or strong chemical cleaners as this will damage the product surface.

## **Check out our full range of Shower Enclosures**

Quadrant Shower Enclosures

Corner Entry Shower Enclosures

Walk in Shower Enclosures

Sliding Shower Doors

Bifold Shower Doors

Pivot Shower Doors

Hinged Shower Doors

Shower Screens

## **From Top Brands**

Coram Shower Enclosures

Mira Shower Enclosures

Hydrolux Shower Enclosures

Diamond Shower Enclosures

## **With quality shower trays to match your enclosure**

Square Shower Trays

Rectangular Shower Trays

Quadrant Shower Trays

Coram Shower Trays

Mira Flight Shower Trays

**plumbworld**  
**Big brands, small prices.**