

Installation Manual

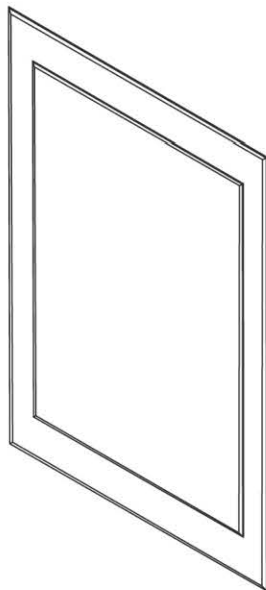

Please retain this manual after installation for future reference and maintenance.

Images are for installation purposes only.



IMPORTANT

Handle with care, impact can damage the mirror.
Use of safety equipment is advised

Tools Required(not provided)

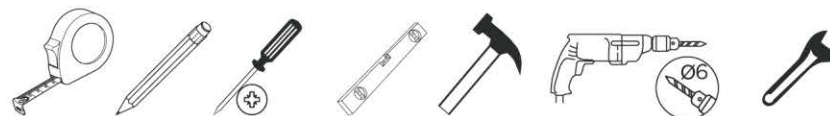

01

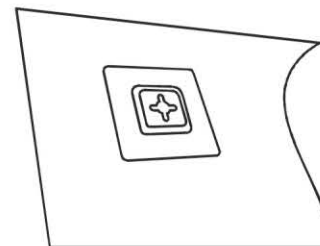

check 4-1

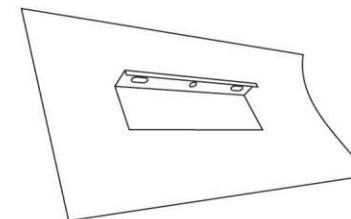

check 4-2

Please Note: There are two different types of fitting bracket please check which style is on the mirror you have purchased.

02

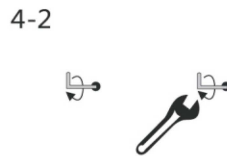
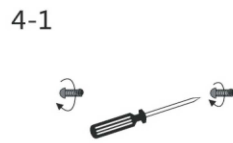
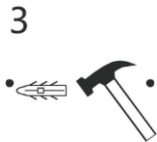

1. Measure the distance between the two brackets on the back of the mirror.
Mark the distance on the wall.

2. Check the marks are level and drill the holes.

3.1 If the mirror is secured by screws, insert the wall plug, thread in the screws and hang the mirror onto the screws.

3.2 If the mirror is secured by the hooks, insert the wall plugs, position the hooks and thread in the screws to fix the hooks, then hang the mirror onto the hooks.

Please note:
make sure the holes on the wall and on the hooks are lined up

3

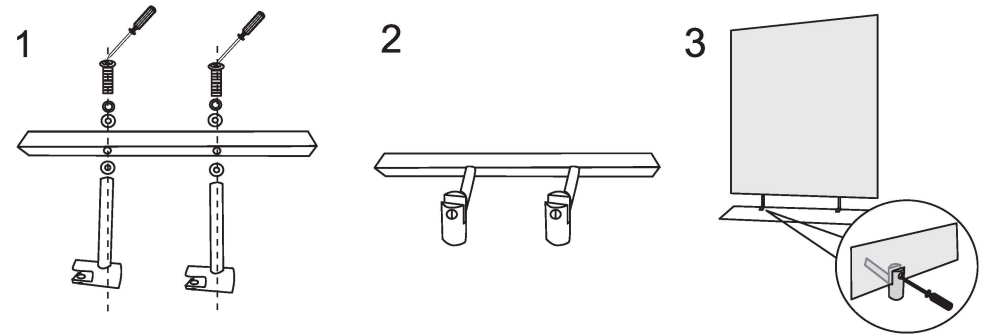

If a product comes without glass shelf, please ignore step 3.

Check out our full range of Bathroom Accessories

Bathroom Accessory Sets

Heated Towel Rails

Bathroom Extractor Fans

Bathroom Lighting

Shower Seats

Grab Rails

Shower Curtains

Toilet Brushes

Bathroom Cleaning Products

Wall Mounted Bathroom Accessories

Robe Hooks

Bathroom Tumblers

Toilet Roll Holders

Soap Dishes

Towel Rings

Shower Caddies

Bathroom Mirrors

Standard Bathroom Mirrors

LED Bathroom Mirrors

Shaving Mirrors

plumbworld
Big brands, small prices.