

5059340136318

5059340136332

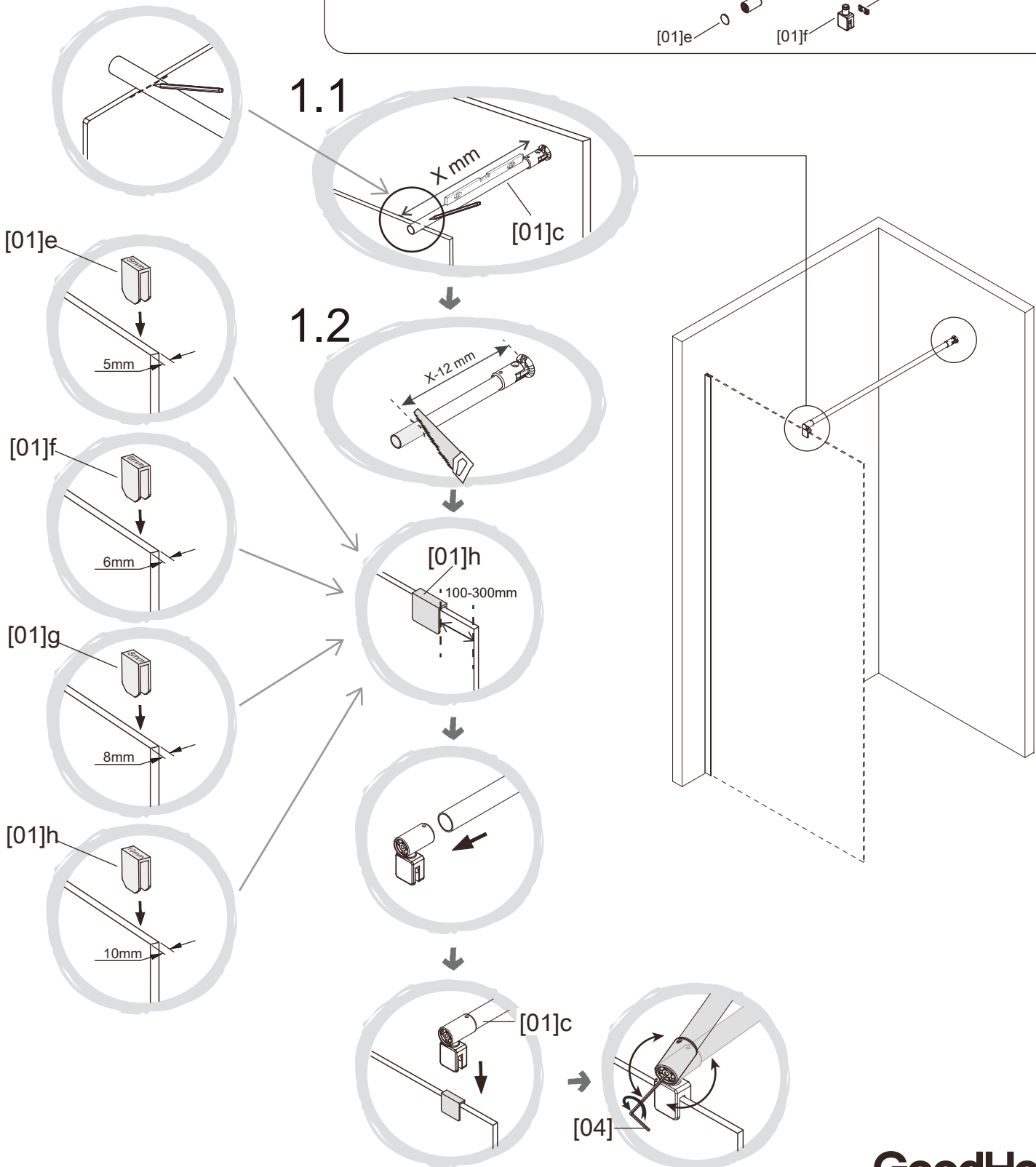

2

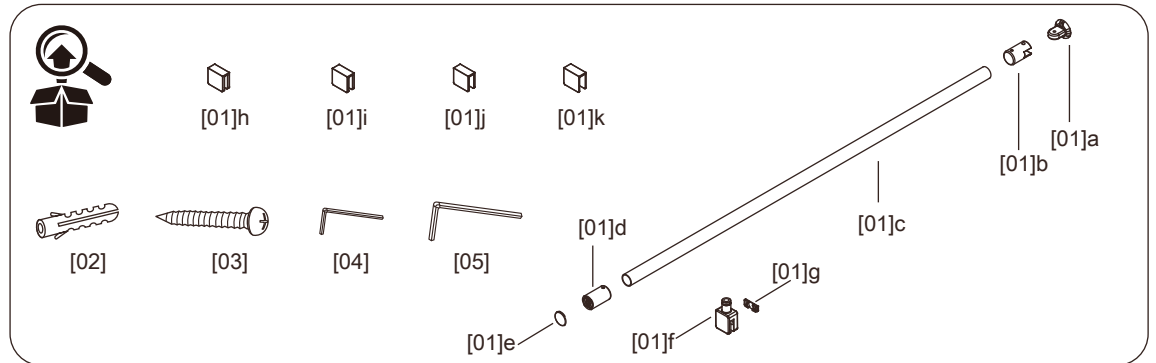