



**DRAPER**<sup>®</sup>

# PETROL INVERTER GENERATOR

95197, 95198



These instructions accompanying the product are the original instructions. This document is part of the product, keep it for the life of the product passing it on to any subsequent holder of the product. Read all these instructions before assembling, operating or maintaining this product.

This manual has been compiled by Draper Tools describing the purpose for which the product has been designed, and contains all the necessary information to ensure its correct and safe use. By following all the general safety instructions contained in this manual, it will ensure both product and operator safety, together with longer life of the product itself.

All photographs and drawings in this manual are supplied by Draper Tools to help illustrate the operation of the product.

Whilst every effort has been made to ensure the accuracy of information contained in this manual, the Draper Tools policy of continuous improvement determines the right to make modifications without prior warning.

# 1. TITLE PAGE

---

## 1.1 INTRODUCTION:

**USER MANUAL FOR: Petrol Inverter Generator**

**Stock No's: 95197, 95198**

**Part No's: DGI2600DI, DGI3500DI**

## 1.2 REVISIONS:

---

**Date first published March 2021.**

---

---

---

As our user manuals are continually updated, users should make sure that they use the very latest version.

**Downloads are available from:** <http://drapertools.com/manuals>

Draper Tools Limited  
Hursley Road  
Chandler's Ford  
Eastleigh  
Hampshire  
SO53 1YF  
UK

**Website:** [drapertools.com](http://drapertools.com)

**Product Help Line:** +44 (0) 23 8049 4344

**General Fax:** +44 (0) 23 8026 0784

## 1.3 UNDERSTANDING THIS MANUALS SAFETY CONTENT:

**Warning!** – Information that draws attention to the risk of injury or death.

**Important** – Information that draws attention to the risk of damage to the product or surroundings.

## 1.4 COPYRIGHT © NOTICE:

Copyright © Draper Tools Limited.

Permission is granted to reproduce this publication for personal and educational use only.

Commercial copying, redistribution, hiring or lending is prohibited.

No part of this publication may be stored in a retrieval system or transmitted in any other form or means without written permission from Draper Tools Limited.

In all cases this copyright notice must remain intact.

# 2. CONTENTS

---

## 2.1 TABLE OF CONTENTS

<b>1. TITLE PAGE</b>		
1.1 INTRODUCTION: .....	2	
1.2 REVISIONS: .....	2	
1.3 UNDERSTANDING THIS MANUALS SAFETY CONTENT: ..	2	
1.4 COPYRIGHT © NOTICE: .....	2	
<b>2. CONTENTS</b>		
2.1 TABLE OF CONTENTS .....	3	
<b>3. WARRANTY</b>		
3.1 WARRANTY .....	4	
<b>4. INTRODUCTION</b>		
4.1 SCOPE .....	5	
4.2 SPECIFICATION .....	5	
4.3 HANDLING AND STORAGE .....	6	
<b>5. HEALTH AND SAFETY INFORMATION</b>		
5.1 GENERAL SAFETY INSTRUCTIONS FOR POWER TOOL USE .....	7	
5.2 ADDITIONAL SAFETY INSTRUCTIONS FOR GENERATOR USE .....	8	
5.3 RESIDUAL RISK .....	9	
<b>6. TECHNICAL DESCRIPTION</b>		
6.1 IDENTIFICATION – MAIN FEATURES .....	10	
6.2 IDENTIFICATION – SWITCH PANEL .....	11	
<b>7. UNPACKING AND CHECKING</b>		
7.1 PACKAGING .....	11	
7.2 WHAT'S IN THE BOX .....	11	
<b>8. PREPARING THE GENERATOR</b>		
8.1 CONNECTING TO EARTH .....	12	
8.2 HANDLING & STORAGE .....	12	
8.3 ADDING ENGINE OIL .....	12	
8.4 ADDING FUEL .....	13	
<b>9. OPERATING INSTRUCTIONS</b>		
9.1 PRE-OPERATION CHECK .....	14	
9.2 STARTING THE GENERATOR ..	14	
9.3 ECONOMY SWITCH .....	15	
9.4 STOPPING THE GENERATOR ..	15	
9.5 OVERLOAD CUT-OUT FOR SOCKET-OUTLETS .....	15	
9.6 AC APPLICATIONS .....	16	
9.7 DC POWER .....	16	
9.8 DC POWER (TOPPING UP CAR BATTERIES) .....	16	
9.9 DC OVERLOAD PROTECTOR ..	17	
9.10 INDICATOR LIGHTS .....	17	
<b>10. MAINTENANCE AND TROUBLESHOOTING</b>		
10.1 THE IMPORTANCE OF MAINTENANCE .....	18	
10.2 MAINTENANCE SCHEDULE .....	18	
10.3 AIR CLEANER SERVICE .....	19	
10.4 SPARK PLUG .....	19	
10.5 CHECKING OIL LEVEL .....	20	
10.6 CHANGE ENGINE OIL .....	20	
10.7 FUEL TANK FILTER .....	20	
10.8 TROUBLESHOOTING .....	20	
<b>11. DISPOSAL</b>		
11.1 DISPOSAL .....	21	
<b>12. EXPLANATION OF SYMBOLS</b>		
12.1 EXPLANATION OF SYMBOLS .....	22	

## 3. WARRANTY

---

### 3.1 WARRANTY

Draper tools have been carefully tested and inspected before shipment and are guaranteed to be free from defective materials and workmanship.

Should the tool develop a fault, please return the complete tool to your nearest distributor or contact:

**Draper Tools Limited, Chandler's Ford, Eastleigh, Hampshire, SO53 1YF. England.**

**Telephone Sales Desk: +44 (0) 8049 4333 or Product Help Line +44 (0) 23 8049 4344.**

A proof of purchase **must** be provided with the tool.

If upon inspection it is found that the fault occurring is due to defective materials or workmanship, repairs will be carried out free of charge. This warranty period covering labour is 12 months from the date of purchase except where tools are hired out when the warranty period is 90 days from the date of purchase. The warranty is extended to 24 months for parts only. This warranty does not apply to any consumable parts, any type of battery or normal wear and tear, nor does it cover any damage caused by misuse, careless or unsafe handling, alterations, accidents, or repairs attempted or made by any personnel other than the authorised Draper warranty repair agent.

**Note:** If the tool is found not to be within the terms of warranty, repairs and carriage charges will be quoted and made accordingly.

This warranty applies in lieu of any other warranty expressed or implied and variations of its terms are not authorised.

Your Draper warranty is not effective unless you can produce upon request a dated receipt or invoice to verify your proof of purchase within the warranty period.

Please note that this warranty is an additional benefit and does not affect your statutory rights.

**Draper Tools Limited.**

## 4. INTRODUCTION

---

### 4.1 SCOPE

This manual is intended to give an overview of the functioning and controls of the machine to aid in its safe use.

### 4.2 SPECIFICATION

Stock No.	.....95197 .....	95198
Part No.	.....DGI2600DI .....	DGI3500DI
Engine type	..... Four cycle OHV .....	Four cycle OHV
Displacement	..... 125cc.....	149.5cc
Rated power	..... 2300W.....	2800W
Rated current	.....10A.....	12.17A
Max power	..... 2500W.....	3100W
Cooling system	..... Forced air .....	Forced air
Output sockets:		
Rated AC	..... 2 × 230V .....	2 × 230V
Rated AC frequency	..... 50Hz .....	50Hz
Rated DC	..... 12V @ 5.0A.....	12V @ 5.0A
Suitable battery type to charge	..... WET LEAD ACID.....	WET LEAD ACID
Performance class	..... G1 .....	G1
Grade	..... A .....	A
Degree of protection	..... IP23M .....	IP23M
Oil capacity	..... 0.9L.....	0.9L
Engine oil	..... SAE 10W-30 .....	SAE 10W-30
Fuel tank capacity	..... 7.5L.....	7.5L
Fuel type	..... Unleaded petrol (RON95) .....	Unleaded petrol (RON95)
Runtime (100% load)	..... 5hrs.....	3.4hrs
Noise level 4M	..... 94dB(A).....	96dB(A)
Uncertainty (K)	..... 3dB(A).....	3dB(A)
Altitude	..... 1000m.....	1000m
Max. ambient temperature	..... 40°C .....	40°C
Dimensions (L×W×H)	.....695 × 395 × 560mm .....	695 × 395 × 560mm
Weight	..... 33kg nett / 36kg gross .....	33.5kg nett / 37.5kg gross

## 4. INTRODUCTION

---

### 4.3 HANDLING AND STORAGE

**Caution:** Always use and store this generator correctly, never use or store this generator on it's side as oil or fuel may leak and damage the generator or your property.

If the generator has been used always allow it to cool for at least 30 minutes before transporting the generator and ensure that the generator has fully cooled before returning it to storage as a hot engine and exhaust system could cause personal injury or ignite some materials.

To prevent fuel/oil spillage when transporting, the generator should be secured upright in it's normal operating position with the engine switch in the off position.

Take care not to drop or strike the generator when transporting. Never cover the generator when in use.

Before storing the generator for a long period:-

1. Be sure that the storage area is free of excessive humidity and dust.
2. Drain the fuel, storage procedure below.
  - A. Unscrew the fuel tank cap, remove the filter screen and empty the fuel tank into an approved petrol container using a commercially available hand siphon (Draper Stock No.43650), re-install the filter screen and fuel tank cap.
  - B. Loosen the carburettor drain screw and drain the carburettor into a suitable container.
  - C. Remove the spark plug maintenance cover and remove the spark plug cap.
  - D. Turn the engine switch to the OFF position.

## 5. HEALTH AND SAFETY INFORMATION

---

### 5.1 GENERAL SAFETY INSTRUCTIONS FOR POWER TOOL USE

When using any type of power tool there are steps that should be taken to make sure that you, as the user, remain safe.

Common sense and a respect for the tool will help reduce the risk of injury.

**Read the instruction manual fully.** Do not attempt any operation until you have read and understood this manual.

Most important you must know how to safely start and stop this machine, especially in an emergency.

**Keep the work area tidy and clean.** Attempting to clear clutter from around the machine during use will reduce your concentration. Mess on the floor creates a trip hazard. Any liquid spilt on the floor could result in you slipping.

**Find a suitable location.** If the machine is bench mounted, the location should provide good natural light or artificial lighting as a replacement. Avoid damp and dust locations as it will have a negative effect on the machine's performance. If the machine is portable do not expose the tool to rain. In all cases do not operate power tools near any flammable materials.

**Keep bystanders away.** Children, onlookers and passers by must be restricted from entering the work area for their own protection. The barrier must extend a suitable distance from the tool user.

Unplug and house all power tools that are not in use. A power tool should never be left unattended while connected to the power supply. They must be housed in a suitable location, away locked up and from children. This includes battery chargers.

**Do not overload or misuse the tool.** All tools are designed for a purpose and are limited to what they are capable of doing. Do not attempt to use a power tool (or adapt it in any way) for an application it is not designed for. Select a tool appropriate for the size of the job. Overloading a tool will result in tool failure and user injury. This covers the use of accessories.

**Dress properly.** Loose clothing, long hair and jewellery are all dangerous because they can become entangled in moving machinery. This can also result in parts of body being pulled into the machine. Clothing should be close fitted, with any long hair tied back and jewellery and neck ties removed. Footwear must be fully enclosed and have a non-slip sole.

**Wear personal protective equipment (PPE).** Dust, noise, vibration and swarf can all be dangerous if not suitably protected against. If the work involving the power tool creates dust or fumes wear a dust mask. Vibration to the hand, caused by operating some tools for longer periods must be protected against. Wear vibration reducing gloves and allow long breaks between uses. Protect against dust and swarf by wearing approved safety goggles or a face shield. These are some of the more common hazards and preventions, however, always find out what hazards are associated with the machine/work process and wear the most suitable protective equipment available.

**Do not breathe contaminated air.** If the work creates dust or fumes connect the machine (if possible) to an extraction system either locally or remotely. Working outdoors can also help if possible.

**Move the machine as instructed.** If the machine is hand held, do not carry it by the power supply cable. If the product is heavy, employ a second or third person to help move it safely or use a mechanical device. Always refer to the instructions for the correct method.

**Do not overreach.** Extending your body too far can result in a loss of balance and you falling. This could be from a height or onto a machine and will result in injury.

**Maintain your tools correctly.** A well maintained tool will do the job safely. Replace any damaged or missing parts immediately with original parts from the manufacturer. As applicable, keep blades sharp, moving parts clean, oiled or greased, handles clean, and emergency devices working.

**Wait for the machine to stop.** Unless the machine is fitted with a safety brake, some parts may continue to move due to momentum. Wait for all parts to stop, then unplug it from the power supply

## 5. HEALTH AND SAFETY INFORMATION

---

before making any adjustments, carrying out maintenance operations or just finishing using the tool.

**Remove and check setting tools.** Some machinery requires the use of additional tools or keys to set, load or adjust the power tool. Before starting the power tool always check to make certain they have been removed and are safely away from the machine.

**Prevent unintentional starting.** Before plugging any machine in to the power supply, make sure the switch is in the OFF position. If the machine is portable, do not hold the machine near the switch and take care when putting the machine down, that nothing can operate the switch.

**Carefully select an extension lead.** Some machines are not suitable for use with extension leads. If the tool is designed for use outdoors, use an extension lead also suitable for that environment. When using an extended lead, select one capable of handling the current (amps) drawn by the machine in use. Fully extend the lead regardless of the distance between the power supply and the tool. Excess current (amps) and a coiled extension lead will both cause the cable to heat up and can result in fire.

**Concentrate and stay alert.** Distractions are likely to cause an accident. Never operate a power tool if you are under the influence of drugs (prescription or otherwise), including alcohol or if you are feeling tired. Being disorientated will result in an accident.

**Have this tool repaired by a qualified person.** This tool is designed to conform to the relevant international and local standards and as such should be maintained and repaired by someone qualified, using only original parts supplied by the manufacturer. This will ensure the tool remains safe to use.

### 5.2 ADDITIONAL SAFETY INSTRUCTIONS FOR GENERATOR USE

**Note:** Generators are designed to give safe and dependable service if operated according to instructions. Read and understand this owners manual fully before operating this generator. You can help prevent accidents by being familiar with the generators controls and by observing safe operating procedures.

#### **Operator responsibility**

- Know how to stop the generator quickly in case of emergency.
- Understand the use of all the generators controls, output sockets and connections.
- Be sure that anyone who operates the generator receives proper instruction in it's safe use.

#### **Warning! Carbon monoxide hazards**

- Exhaust gases contain poisonous carbon monoxide, a colourless and odourless gas.
- Breathing carbon monoxide can cause loss of consciousness and may lead to death.

**NEVER** run this generator in an enclosed space or partly enclosed space.

**ALWAYS** ensure a high level of ventilation in the area that you intend to use the generator to avoid the potential build up of carbon monoxide.

#### **Warning! Electric shock hazards**

- The generator produces enough electric power to cause a serious shock or electrocution if misused.
- Using a generator or electrical appliance in wet conditions, such as rain or snow, or near a pool or sprinkler system, or when your hands are wet, could result in electrocution. Keep the generator dry.
- If the generator is stored outdoors, unprotected from the weather, check all of the electrical components on the control panel before each use. Moisture or ice can cause a malfunction or short circuit in electrical components which could result in electrocution.
- Do not connect to a building electrical system unless an isolation switch has been installed by a qualified electrician.
- Never connect different generator models and types.



## 5. HEALTH AND SAFETY INFORMATION

---

### **Warning! Fire and burn hazards**

- The exhaust system gets hot enough to ignite some materials.
- Keep the generator at least 3 feet (1 metre) away from buildings and other equipment during operation.
- Do not enclose the generator in any structure.
- Keep flammable materials away from the generator.
- The muffler becomes very hot during operation and remains hot for a while after stopping the engine. Be careful not to touch the muffler while it is hot. Let the engine cool before storing the generator indoors.
- Petrol is extremely flammable and is explosive under certain conditions. Do not smoke or allow flames or sparks where the generator is refuelled or where petrol is stored. Refuel in a well-ventilated area with the engine stopped.
- Fuel vapours are extremely flammable and may ignite after the engine has started. Make sure that any spilled fuel has been wiped up before starting the generator.

### **5.3 RESIDUAL RISK**

**Important:** Although the safety instructions and operating manuals for our tools contain extensive instructions of safe working with power tools, every power tool involves a certain residual risk which can not be completely excluded by safety mechanisms. Power tools must therefore always be operated with caution!

## 6. TECHNICAL DESCRIPTION

### 6.1 IDENTIFICATION – MAIN FEATURES



① Air vent knob.

② Fuel cap.

③ Fuel valve knob.

④ Starting handle.

⑤ Side maintenance covers.

⑥ Primer bulb.

⑦ Choke.

⑧ Exhaust.

⑨ Top maintenance cover.

⑩ Transport wheels.

⑪ Transport handle.

# 6. TECHNICAL DESCRIPTION

## 6.2 IDENTIFICATION – SWITCH PANEL

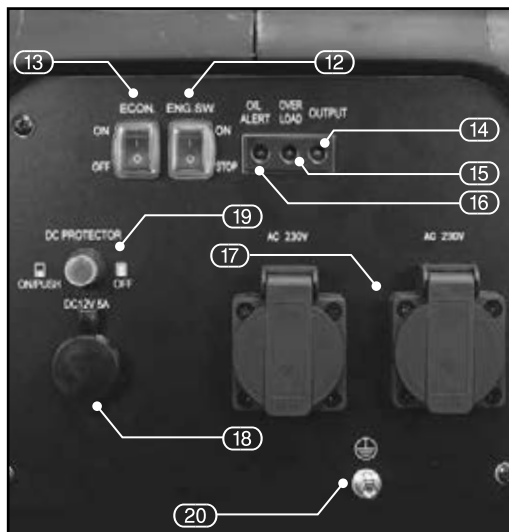

- (12) Engine ON/OFF switch.
- (13) Economy control switch.
- (14) Output indicator.
- (15) Overload indicator.
- (16) Oil alarm indicator.
- (17) 230V AC sockets × 2.
- (18) 12V DC socket.
- (19) DC circuit breaker.
- (20) Earthing point.

# 7. UNPACKING AND CHECKING

## 7.1 PACKAGING

Carefully remove the product from the packaging and examine it for any sign of damage that may have happened during shipping. Lay the contents out and check them against the parts shown below. If any part is damaged or missing, please contact the Draper Help Line (the telephone number appears on the Title page) and do not attempt to use the product.

The packaging material should be retained at least during the warranty period, in case the machine needs to be returned for repair.

### Warning!

- Some of the packaging materials used may be harmful to children. Do not leave any of these materials in the reach of children.
- If any of the packaging is to be thrown away, make sure they are disposed of correctly, according to local regulations.

## 7.2 WHAT'S IN THE BOX

As well as the main product, there are several parts not fitted or attached to it.

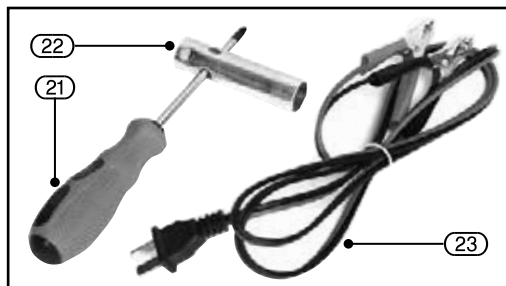

- (21) Cross-slot screwdriver.
- (22) Spark plug box spanner.
- (23) 12V connecting lead assembly.

**Note:** For details of our full range of accessories and consumables, please visit [drapertools.com](http://drapertools.com)

## 8. PREPARING THE GENERATOR

### 8.1 CONNECTING TO EARTH – FIG.1

The generator must be earthed to discharge static electricity. Attach a cable to the connection (20) on the faceplate, the other end to external earth (for example an earth rod which can be purchased at your local camping supplier).

Earthing of generators is covered in BS7430:2011. If you have any doubts about this subject consult a qualified electrician.

### 8.2 HANDLING & STORAGE – FIG.2

**Warning!** Petrol is highly flammable and explosive. You can be burned or seriously injured when handling fuel.

- Keep heat, sparks and flame away.
- Handle fuel outdoors only.
- Wipe up spills immediately.

If storing this machine for a prolonged time there are some procedures to follow to prepare the machine prior to storage:

- Remove any fuel from the fuel tank by using a siphon. Loosen the carburettor drain screw and drain remaining fuel into a suitable container prior to correct disposal of old fuel (check local regulations).
- Check the machine over and repair or replace any worn or damaged parts.
- Remove the spark plug and pour about a tablespoon of clean engine oil into the cylinder.
- Crank the engine several revolutions to distribute the oil, then re-install the spark plug.
- Re-install the spark plug cap on the spark plug securely.
- Pull the starter grip slowly until you feel resistance, then return the starter grip gently. This closes the valves so moisture cannot enter.

**Warning!** The generator is shipped without oil in the engine. You **MUST** add the required amount of oil before trying to start the engine.

### 8.3 ADDING ENGINE OIL – FIGS. 3 – 4

- Remove the screws (5.1) and side maintenance cover (5).
- With the generator on a level surface, remove the oil filler cap/dipstick (24).
- Add exactly: 0.90L SAE10W-30 oil.

**Warning!** Do not overfill the engine with oil

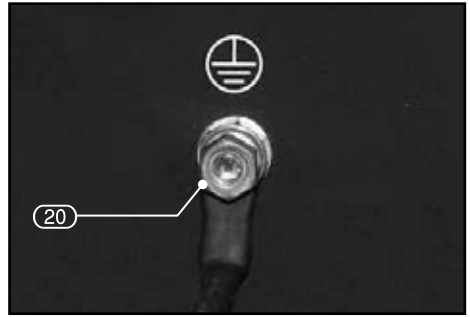

FIG.1



FIG.2

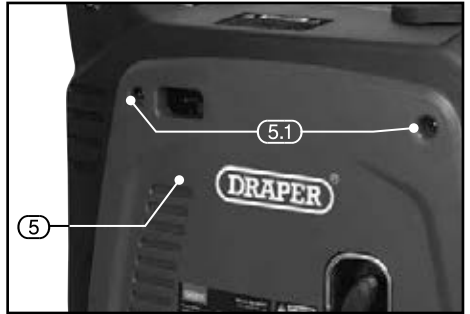

FIG.3



FIG.4

## 8. PREPARING THE GENERATOR

If the engine is overfilled, the excess oil may be transferred to and contaminate the air filter and it's housing.

– Screw in the filler cap/dipstick securely.

**Caution:** prolonged exposure to used engine oil is dangerous, always wash your hands thoroughly after handling used engine oil.

### Environmental protection

One of the most damaging sources of pollution is oil. Do not throw away used engine oil in with your domestic waste or down drains and sinks. Place it in a leak proof container and dispose of it according to local regulations.

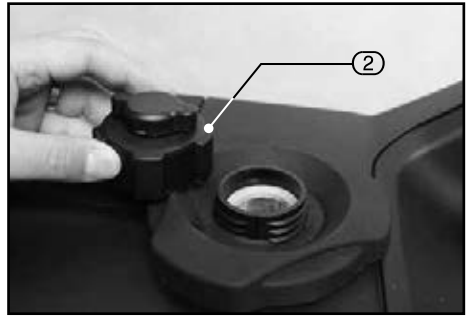

FIG.5

### 8.4 ADDING FUEL – FIG.5

Remove cap (2) fill with unleaded petrol (RON95), do not over fill, allow room for fuel expand when it heats up. Replace cap.

Never use stale or contaminated petrol or an oil/petrol mixture. Avoid getting dirt or water in the fuel tank.

If the fuel level is low, refuel in a well-ventilated area with the engine stopped. If the engine has been running, allow it to cool first. Never refuel the engine inside a building where petrol fumes can reach flames or sparks.

**Warning!:** Petrol is highly flammable and explosive.

You can be burned or seriously injured when handling fuel.

- Stop the engine and keep heat, sparks and flames away.
- Handle fuel only outdoors.
- Wipe up spills immediately.

# 9. OPERATING INSTRUCTIONS

## 9.1 PRE-OPERATION CHECK – FIG.6

Once the machine has been prepared for use, ensure the following pre-operation checks are carried out.

- Check the generator over for any signs of fuel.
- Check the level of engine oil and top-up as required.

This generator has a Low Oil level Protection system. The oil shortage alarm indicator (16) lights if there is too little oil in the engine. In this case it will not be possible to start the engine or it will cut out automatically after a short period of time. It cannot be started again until the engine oil has been topped up.

**Warning!** Running this machine with too little or too much oil can cause serious damage and would not be covered under warranty.

- Check to ensure that there is no damage to the machine's casing and control panel.
- Once you are satisfied that the machine is undamaged and in a good serviceable condition, you are ready to start the machine.
- Ensure that all operatives have received proper instruction in the safe use of this machine and fully understand it's controls as well as knowing how to stop this machine in an emergency.

## 9.2 STARTING THE GENERATOR – FIGS. 7 – 10

**Warning!** For your safety **DO NOT** operate the generator in an enclosed area such as a garage. The generator's exhaust emits toxic gases containing poisonous carbon monoxide which can cause unconsciousness and even death in high concentrations.

Before connecting loads/appliances to the generator, be sure to read the chapters on AC OPERATION and DC POWER.

Prior to each starting of the machine, perform the pre-operation check.

To start the machine follow these simple steps:-

- Ensure that no appliances are plugged into the machine (starting the machine with appliances connected could cause damage to the appliances).
- Hold the fuel tank cap (2) so that it will not move, and turn the air vent knob (1) to the 'open' position.
- Open the fuel valve knob (3) by turning it to the "ON" position.



FIG.6

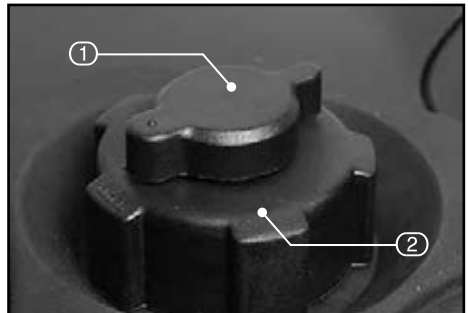

FIG.7

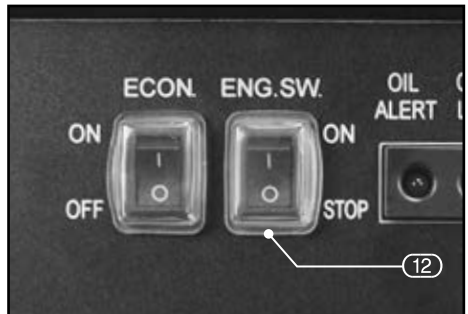

FIG.8

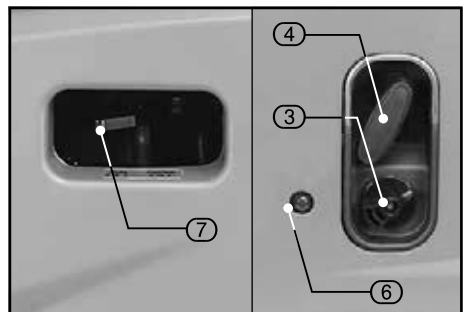

FIG.9

## 9. OPERATING INSTRUCTIONS

- Switch the engine switch (12) to the “ON” position.
- Move the choke lever (7) to the “CHOKE” position to start the engine from cold. The choke is not required to start a warm engine.

**Note:** If this is the first time of use, or the fuel has run out then the primer bulb (6) will need to be pressed a minimum of 6 times to pump fuel into the carburettor.

- Pull the starter handle (4) gently until you feel resistance then give a brisk pull on the starter cord, several pulls on the starter cord may be required to start the engine.

**Note:** Do not allow the extended starter cord to snap back against the engine casing as damage to the starter or housing can occur.

- If the choke lever was moved to the “CHOKE” position to start the engine from cold, gradually move it to the “RUN” position as the engine warms up.

Refer to the following sections titled AC OPERATION and DC POWER for connecting loads to the generator.

### 9.3 ECONOMY SWITCH - FIG. 11

**ON:** The economy switch (13) is recommended to minimize fuel consumption and further reduce noise levels when no load is applied to the generator. Engine speed varies with the load.

**OFF:** The smart throttle system does not operate.

**Caution:** The economy control does not work effectively if the electrical appliance requires ‘bursts’ of power.

**Caution:** Turn the economy control feature off when connecting high load appliances or when connecting to the DC output.

### 9.4 STOPPING THE GENERATOR

To stop the engine in an emergency, switch the engine on/off switch to off.

Under normal operating conditions, use the procedure detailed below to stop the generator:-

- Unplug any appliances and/or charging batteries from the generator, if the generator has been working hard allow it to idle for a short time.
- Switch the engine ON/OFF switch (12) to OFF.
- Switch economy switch (13) to OFF.
- Turn fuel tap off (3).
- Close air vent (1).
- Allow the engine to fully cool before transporting or returning to storage.

### 9.5 OVERLOAD CUT-OUT FOR SOCKET-OUTLETS

**Important!** The generator is equipped with an electronic overload protection which switches off the sockets in case of overload.

When the overload cut off is displayed (6), turn off the power generator and remove the

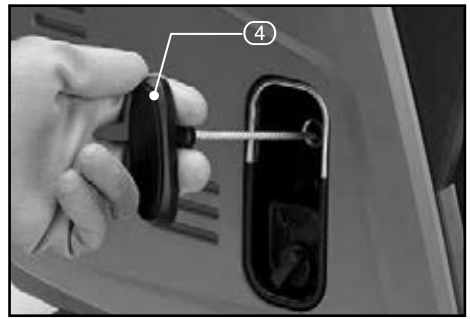

FIG.10

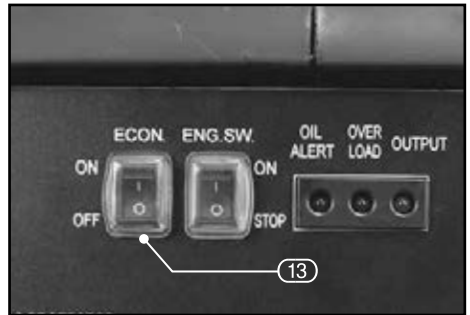

FIG.11

## 9. OPERATING INSTRUCTIONS

---

connected equipment from the generator.

This will reset the overload cut-off and allow you to turn the generator back on.

If this happens, reduce the electric power you are taking from the generator or remove any defective connected appliances.

Defective overload cut-outs must be replaced only by overload cut-outs of identical design and with the same performance data. If repairs are necessary, please contact your customer service centre.

### 9.6 AC APPLICATIONS

Before connecting an appliance or power cord to the generator:-

**Note:** Allow 2-3 minutes after starting the generator to allow the generator to settle before connecting AC appliances and using the throttle economy switch.

1. Make sure that it is in good working order. Faulty appliances or power cords can create the potential for electric shock.
2. If an appliance begins to operate abnormally in any way, turn it off immediately and disconnect it from the generator and check that the appliance does not exceed the generators maximum rating.

Always make sure that the appliances power rating does not exceed the generator's maximum rating.

In either case the total power requirements (VA) of all appliances connected must be considered. The above limits must not be exceeded.

When powering sensitive electronics it is advisable to only power a single appliance at a time.

**Note:** Substantial overloading will switch off the engine. Exceeding the limits for maximum power operation or slightly overloading the generator may not switch off the generator but will shorten the service life of the generator.

The AC output is Pure Sine Wave so it's safe for sensitive appliances such as laptops or appliances with a digital panel. It can also power induction plates and microwave ovens.

### 9.7 DC POWER

- Set the economy control switch to 'OFF'.
- Start the generator.
- Make sure the appliance is turned off before connecting it to the generator.
- Connect the 12V appliance (max 4A) to the generator.

### 9.8 DC POWER (TOPPING UP CAR BATTERIES) – FIGS. 12 – 13

**Warning!** For your safety perform the following instructions in the order shown.

**Warning!** You should only use this generator to 'top up' a WET battery, also trying to charge a completely flat battery may cause the fuse to blow.

- Set the economy control switch (13) to 'OFF'.
- Start the generator.
- Connect the battery charging leads (23) to the battery.
- Make sure you clamp the red wire to the positive (+) terminal and the black wire to the negative (-) terminal of the battery.
- Connect the battery charging leads to the generator via the 12V DC socket (18).

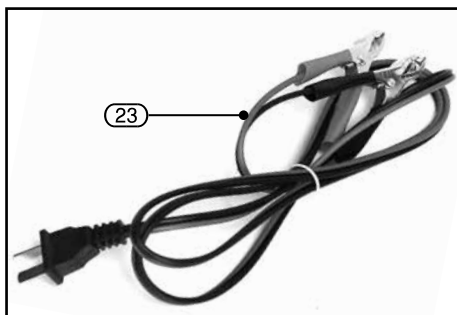

FIG.12



## 9. OPERATING INSTRUCTIONS

- The battery will begin to charge.
- Monitor the voltage across the battery regularly during charging and disconnect the battery when the voltage reaches 14.4 volts.
- Caution: when disconnecting the battery, always disconnect the negative lead first.

### 9.9 DC OVERLOAD PROTECTOR

If the DC overload protector activates, wait for a few minutes and then press the reset button (10).

### 9.10 INDICATOR LIGHTS – FIG. 14

**OUTPUT** indicator (14) (Green) will remain on during normal operation.

**OVERLOAD** indicator (15) (Red) will light up if there is an overload or a short circuit in the connected appliance.

If this happens, proceed as follows:

- Turn off any connected electrical devices and stop the engine.
- Reduce the total wattage of connected electric devices to within the rated output of the generator.
- Check air inlet and around the control unit. If any blockages are found, remove them.
- After checking, restart the engine.

### **OIL ALERT** indicator (16)

The oil alert indicator (Red) will light up when the oil level is low.

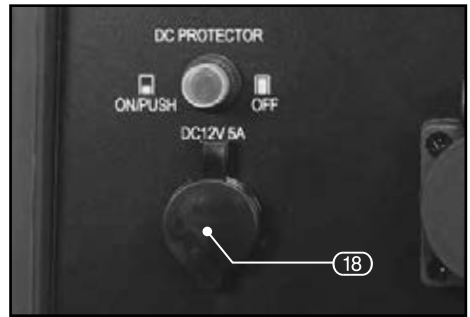

FIG.13

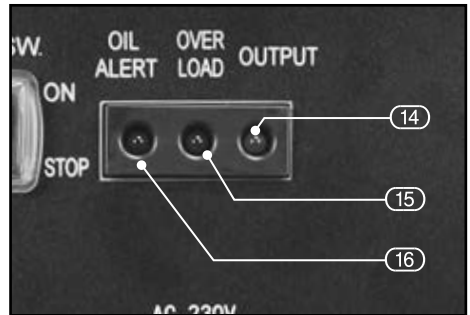

FIG.14

# 10. MAINTENANCE AND TROUBLESHOOTING

## 10.1 THE IMPORTANCE OF MAINTENANCE

Good maintenance is essential for the safe, economical and trouble-free operation of the generator. It will also help reduce air pollution.

**Warning!** Improper maintenance, or failure to correct a problem before operation, can cause a malfunction in which could cause serious injury or death.

Always follow the inspection and maintenance recommendations and schedules in this owner's manual.

To help you to properly care for your generator, the following pages include a maintenance schedule, routine inspection procedures and simple maintenance procedures using basic hand tools. Other service tasks that are more difficult, or require special tools, are best handled by professionals and are normally performed by a technician or other qualified mechanic.

The maintenance schedule applies to normal operating conditions. If you operate your generator under severe conditions, such as sustained high-load or high temperature operation, or use it in usually wet or dusty conditions, consult your servicing dealer for recommendations applicable to your individual needs and use.

Remember that your servicing dealer knows your generator best and is fully equipped to maintain and repair it. To ensure the best quality and reliability, use only new, genuine Draper parts for repair or replacement.

## 10.2 MAINTENANCE SCHEDULE

Regular service period		Before each use	First month or 20 hours	Every 3 months or 50 hours	Every 6 months or 100 hours	Every 2 years or 300 hours
Item	Perform at every indicated month or operating hour interval, whichever comes first.					
Engine oil	Check level	●				
	Change		●	●		
Air cleaner	Check	●				
	Clean			● (1)		
Spark plug	Check/adjust			●		
	Replace				●	
Spark arrester	Clean				●	
Valve clearance	Check/adjust					● (2)
Combustion camber	Clean	After every 300 hrs. (2)				
Fuel tank and filter	Clean			● (2)		
Fuel line	Check	Every 2 years (replace if necessary) (2)				

(1) Service more frequently when used in dusty areas.

(2) These items should be serviced by your servicing dealer, unless the owner has the proper tools and is mechanically proficient. Failure to follow this maintenance schedule could result in non-warrantable failures.

# 10. MAINTENANCE AND TROUBLESHOOTING

## 10.3 AIR CLEANER SERVICE – FIGS. 15 – 17

A dirty air cleaner will restrict air flow to the carburettor. To prevent carburettor malfunction, service the air cleaner regularly. Service more frequently when operating the generator in extremely dusty areas.

**Caution!** Operating the engine without an air filter or with a damaged air filter will allow dirt to enter the engine, causing rapid engine wear.

This type of damage is not covered by the Draper warranty.

- Remove the side maintenance cover (5) by firstly removing the two retaining screws (5.1) (see 8.3 ADDING ENGINE OIL – page 12).
- Remove the air filter housing unit (25) by firstly removing the two retaining nuts (25.1).
- Remove the air filter housing unit (25) element.
- Pull off the cover of the air filter housing unit (25.2) to access the filter element (25.3).

**Warning!** Using petrol or flammable solvent to clean the air filter can cause a fire or explosion. Use only soapy water or non-flammable solvent, once it is completely dry immerse the filter in clean engine oil and squeeze the filter to remove excess oil.

## 10.4 SPARK PLUG – FIG. 18

Remove and check spark plug for dirt and grime and if necessary clean with a copper wire brush.

- Remove the top maintenance panel (9).
- Pull off the spark plug boot (26) with a twist.
- Use the screwdriver (21) supplied to turn the spark plug box spanner (22) to remove the spark plug as shown.
- Check the spark plug gap with a feeler gauge, it should be between 0.6 and 0.7 mm.

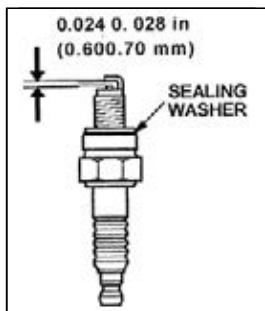

FIG.15

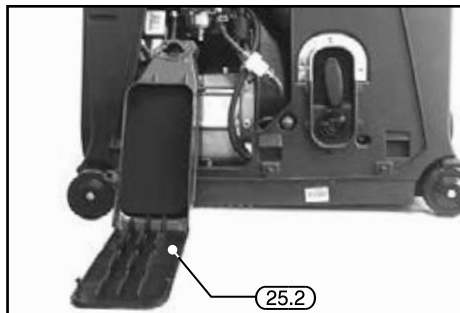

FIG.16

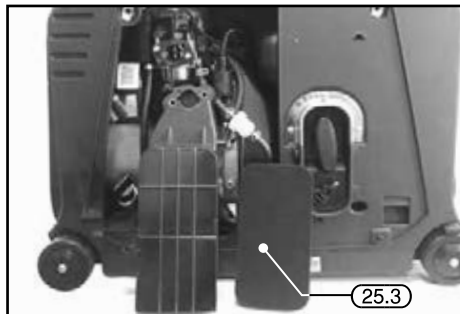

FIG.17

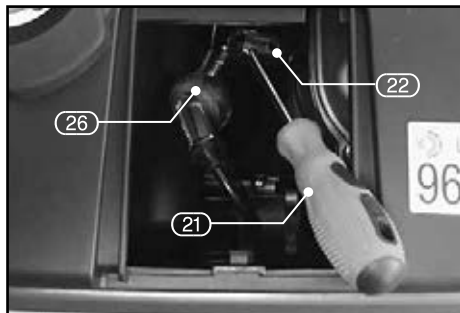

FIG.18

# 10. MAINTENANCE AND TROUBLESHOOTING

## 10.5 CHECKING OIL LEVEL

(See also page 12: Section 8.3 ADDING ENGINE OIL)

- Screw off the Oil filler plug and wipe off any oil on the dip stick.

**Important!** Do not screw the dipstick in to check the oil level; simply insert it up to the thread.

- Check the dip stick; make sure the oil level is between “both marks”.

## 10.6 CHANGE ENGINE OIL – FIG.19

(See also page 12: Section 8.3 ADDING ENGINE OIL)

The motor oil is best changed when the motor is at working temperature.

- Place the generator on a slightly inclined surface so that the oil filler is at the lower end.
- Let the hot engine oil drain out into a drip tray.
- After the old oil has drained out, place the generator back on a level surface again and re-fill with clean motor oil (SAE10W-30).

## 10.7 FUEL TANK FILTER – FIG.20

Lift out the filter (2.1) and clean the with solvent.



FIG.19

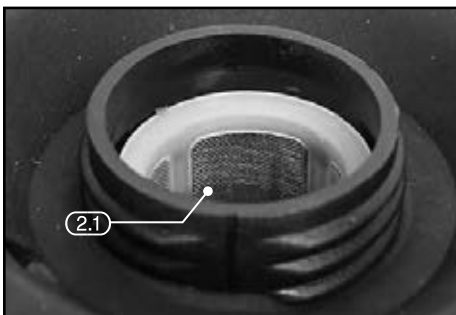

FIG.20

## 10.8 TROUBLESHOOTING

Fault	Cause	Remedy
<b>Engine does not start</b>	<ul style="list-style-type: none"><li>– Oil shortage cut-out has not responded</li><li>– Spark plug fouled</li><li>– No fuel</li></ul>	<ul style="list-style-type: none"><li>– Check oil level, top up engine oil</li><li>– Clean or replace spark plug (electrode spacing 0.6-0.7 mm)</li><li>– Refuel / check the petrol cock</li></ul>
<b>Generator has too little or no voltage</b>	<ul style="list-style-type: none"><li>– Controller or capacitor defective</li><li>– Overload cut-off has triggered</li><li>– Air filter dirty</li></ul>	<ul style="list-style-type: none"><li>– Contact your dealer</li><li>– Actuate the circuit-breaker and reduce the consumers</li><li>– Clean or replace the filter</li></ul>

# 11. DISPOSAL

---

## 11.1 DISPOSAL

- At the end of the machine's working life, or when it can no longer be repaired, ensure that it is disposed of according to national regulations.
- Contact your local authority for details of collection schemes in your area.

In all circumstances:

- Do not dispose of power tools with domestic waste.
- Do not incinerate.
- Do not dispose of WEEE\* as unsorted municipal waste.



\* *Waste Electrical & Electronic Equipment.*

# 12. EXPLANATION OF SYMBOLS

## 12.1 EXPLANATION OF SYMBOLS



Read the instruction manual.



Wear ear defenders.



Do not abandon into the environment.



Keep out of the reach of children.



Keep your distance.



Must be earthed.



WEEE –  
Waste Electrical & Electronic Equipment.  
Do not dispose of Waste Electrical & Electronic  
Equipment in with domestic rubbish.



Continuous A-Weighted Sound  
Pressure Level.



**Warning!**



**Warning!**  
Flammable material.



**Warning!**  
Very hot surfaces.



**Warning!**  
Risk of electrocution.



**Warning!**  
Risk of toxic fumes.



**Do not** operate the machine  
indoors.



**Do not** connect to socket outlets  
when performing maintenance.



**Do not** operate the machine  
without essential lubricating oil.

# NOTES

---

## **CONTACTS**

Draper Tools Limited, Hursley Road,  
Chandler's Ford, Eastleigh, Hampshire. SO53 1YF. U.K.

Help Line: (023) 8049 4344

Sales Desk: (023) 8049 4333

Internet: [drapertools.com](http://drapertools.com)

E-mail: [sales@drapertools.com](mailto:sales@drapertools.com)

General Enquiries: (023) 8026 6355

**Service/Warranty Repair Agent:**

For aftersales servicing or warranty repairs, please contact the Draper Tools Help Line for details of an agent in your local area.

## **YOUR DRAPER STOCKIST**

RDTL0321

©Published by Draper Tools Limited.

No part of this publication may be reproduced, stored in a retrieval system or transmitted in any form or by any means, electronic, mechanical photocopying, recording or otherwise without prior permission in writing from Draper Tools Ltd.