

KNAUF



For every application

High-performance boards
manufactured to EN 520

Specialist boards

Wide range of sizes

Simple and fast to install

Knauf Board range

**A complete range of products and systems for
all environments – even the most demanding**

Build for the world we live in

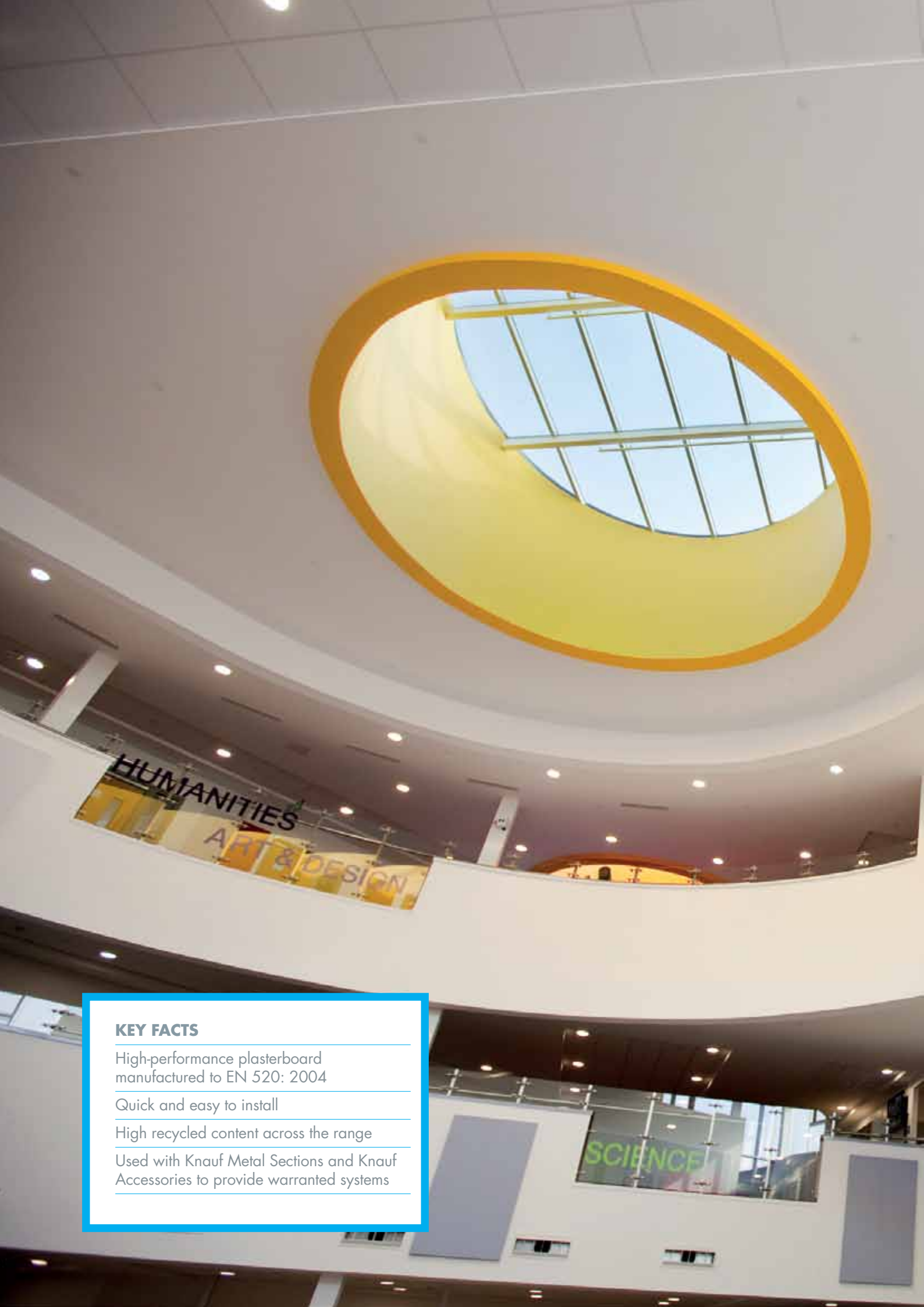

KEY FACTS

High-performance plasterboard
manufactured to EN 520: 2004

Quick and easy to install

High recycled content across the range

Used with Knauf Metal Sections and Knauf
Accessories to provide warranted systems



The right board for every application

Manufactured from the highest-quality gypsum, our plasterboards are versatile, strong and easy to use.

Special additives are used to provide a full range of high-performance boards suited to acoustic, impact, fire-resisting and moisture-resisting applications.

In addition to our high-performance boards, a range of specialist boards is available offering superior performance in specific areas – from high acoustic performance to X-ray shielding and even temperature regulation.

Quick and simple to install and finish, our range covers everything you need to get the job done.

Contents	page
Standard and high-performance boards	5
Insulating laminates	8
Plasterboard selector table	10 - 11
Specialist boards	12 - 17
Case study – New Line Learning Academy	19



The Knauf Plasterboard range

Standard and high-performance board

The Knauf Plasterboard range has been developed to meet all drylining requirements with as few different board types as possible.



The Knauf 'Panel' family

Knauf Wallboard is a cost-effective solution for many standard partition performance requirements. This performance can be enhanced – where additional acoustic, moisture, fire, vapour or impact resistance is required – by Knauf Sound Panel, Moisture Panel, Fire Panel, Vapour Panel and Impact Panel.



Knauf Soundshield Plus

Ideal for commercial projects where sound reduction is of particular importance, its high-mass and tuned core give enhanced levels of acoustic performance as well as greater fire and impact resistance, making it the ideal plasterboard for severe duty applications.



Knauf Performance Plus

Knauf Performance Plus, our highest specification plasterboard, has a high-density core with added performance-enhancing ingredients. The result is a board with extremely high levels of sound, moisture, fire and impact resistance, ideally suited to schools, hospitals and other large commercial projects.



Knauf Core Board

Knauf Core Board is designed to be used in conjunction with the Knauf Shaftwall system. It has both fire and moisture-resistant qualities.



Knauf Plank

Knauf Plank is a 19mm thick plasterboard for use as a key component in many partition and floor systems, where it acts as an acoustic mass layer.

Value engineering with high-performance boards

Knauf Performer partitions can be used to create a variety of fully-warranted system solutions, while Knauf high-performance boards offer the convenience of plasterboard with significantly higher performance.

Using Knauf high-performance boards enables you to achieve the required performance levels with a reduced number of components and plasterboard layers, helping to reduce both material and labour costs.

Acoustic solutions

Knauf Soundshield Plus, with its enhanced acoustic properties, makes 40dB(Rw) possible without the need for additional insulation, reducing labour, waste and complexity on site.

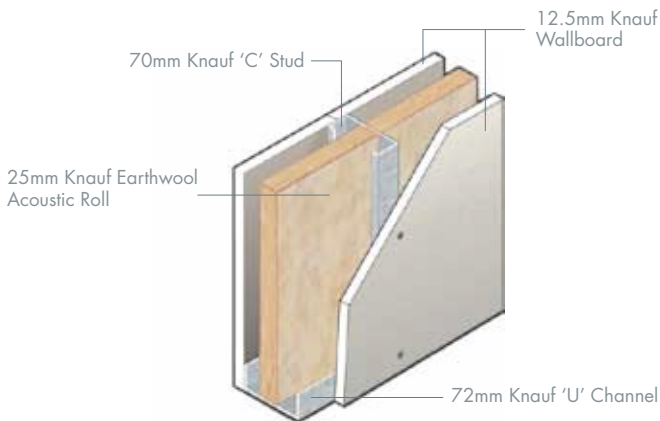

Knauf Wallboard solution for Approved Document E
– Internal wall 40dB(Rw)

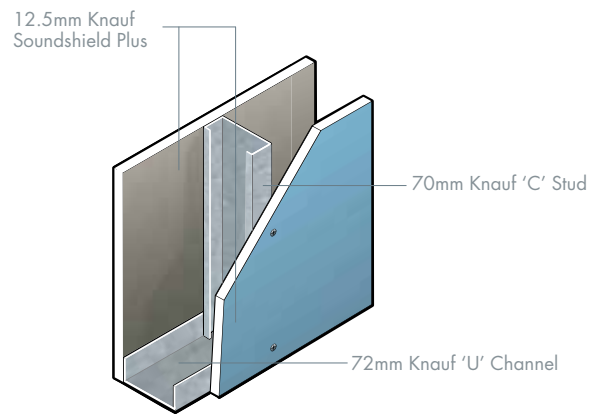

Knauf Soundshield Plus solution for Approved Document E
– Internal wall 40dB(Rw)

Fire-resisting solutions

Knauf Fire Panel contains special additives which increase core cohesion at high temperatures meaning that a single layer of 15mm Knauf Fire Panel each side of a Knauf Performer partition can achieve a one-hour fire rating where two layers of 12.5mm Knauf Wallboard would be required.

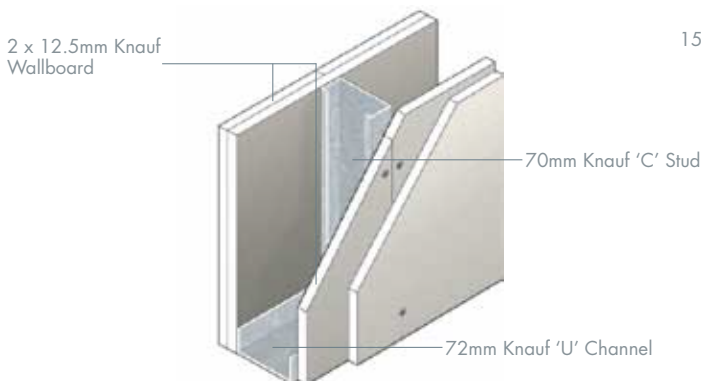

Knauf Wallboard solution for one-hour partition wall

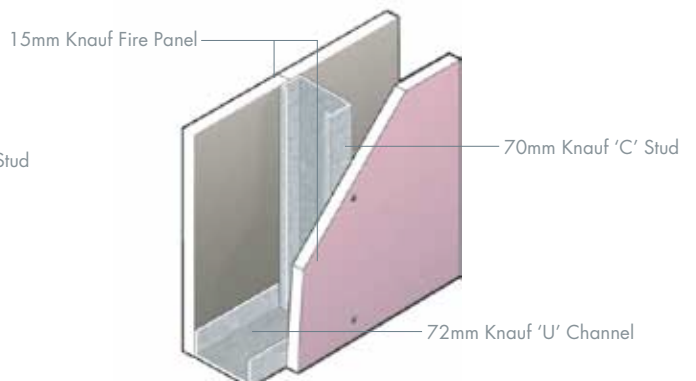

Knauf Fire Panel solution for one-hour partition wall

100% Knauf System – Performance tested and approved

Our systems use Knauf materials throughout – plasterboard, metal, insulation, plaster and accessories. All are manufactured to strict British and European standards and are independently tested together as complete, warranted systems.

Fire, acoustic, robustness and structural performance are all tested for the relevant application. Full details can be found online at www.knauf.co.uk or within The Complete Drywall Manual.

Benefits of using the Knauf System

- ✓ Fully supported at every stage of the project by Knauf's technical and sales support teams both pre-site and during construction.
- ✓ Designed to perform to specified parameters throughout the lifetime of the drywall system.
- ✓ Guaranteed to be repaired or replaced by Knauf under our wide-ranging product performance warranties.



Insulating Laminates

Knauf Insulating Laminates provide an efficient way to achieve instant energy savings, while maximising room space. Knauf Insulating Laminates are supplied with a tapered edge for direct decoration or plaster finish and can be installed using Knauf Plasterboard Adhesive and mechanical fixings.

Knauf PIR Laminate



PIR insulation is CFC and HCFC-free; when bonded to 9.5mm Knauf Wallboard it offers the highest thermal performance, reducing the thickness required. This cost-effective solution is ideal for use in refurbishment, new build and room-in-roof situations where an enhanced level of thermal insulation is required.

Knauf XPS Laminate Plus



CFC and HCFC-free extruded polystyrene bonded to 9.5mm Knauf Wallboard, Knauf XPS Laminate offers enhanced thermal performance at a reduced thickness with the additional advantage of providing good vapour resistance. Ideal for use in refurbishment, new build and room-in-roof situations where an enhanced level of thermal insulation is required.

Knauf Thermal Laminate



Knauf Thermal Laminate offers good levels of thermal insulation by combining 9.5mm Knauf Wallboard with high-quality polystyrene which is both CFC and HCFC-free. This product is ideal for use in both refurbishment and new build.

Knauf Thermal Laminate Vapour Check



Knauf Thermal Laminate Vapour Check offers good levels of thermal insulation by combining 9.5mm Knauf Vapour Panel plasterboard with high-quality polystyrene. This product is ideal for use in both refurbishment and new build. Where an effective vapour check layer is required.

























Knauf Plasterboard selector table

KEY	Standard	Performance boards				
	Wallboard	Vapour Panel	Fire Panel	Sound Panel	Impact Panel	Moisture Panel
Edge profile						
Square edge (SE)						
Tapered edge (TE)						
Board weight						
	Strong and versatile	Creates an effective vapour barrier	Enhanced fire resistance	Enhanced sound performance	Enhanced impact resistance	Enhanced moisture resistance
Edge type	 SE, TE	 SE, TE	 SE, TE	 TE	 TE	 SE, TE
Thicknesses and weights	9.5mm 12.5mm 15mm	12.5mm 15mm	12.5mm 15mm	12.5mm	15mm	12.5mm 15mm
Widths (mm)	900, 1200	900, 1200	900, 1200	1200	1200	1200
Lengths (mm)	1800, 2400, 2500, 2700, 3000	1800, 2400, 3000	1800, 2400, 2700, 3000	2400, 2700	3000	2400, 2700, 3000
EN 520 classification	A	EN14190	A & F	A & D	A, D, F, I & R	A & H2
Thermal conductivity	0.19W/mK	0.19W/mK	0.24W/mK	0.24W/mK	0.24W/mK	0.24W/mK
Applications						
Direct bonding	✓		✓	✓	✓	
Metal furring	✓	✓	✓	✓	✓	
Independent lining	✓	✓	✓	✓	✓	✓
Metal stud partition	✓	✓	✓	✓	✓	✓
Timber stud partition	✓	✓	✓		✓	✓
Isolator partition						
Space-saver partition						
Shaftwall system			✓			
Suspended ceiling	✓	✓	✓	✓	✓	✓

✓1 Two mechanical fixings per board are also required



High-performance boards

Soundshield Plus	Performance Plus	Core Board	Plank	Thermal Laminate	XPS Laminate Plus	PIR Laminate
Enhanced sound performance as well as impact and fire resistance	High levels of sound, moisture, fire and impact resistance	Designed for use with Knauf Shaftwall system	Ideal for reducing sound in party walls and floors	Offers good levels of thermal insulation. Also available in vapour check grade	Offers an enhanced thermal performance	Offers the best thermal performance
						
						
						
TE	TE	SE	SE, TE	TE	TE	TE
12.5mm  15mm 	12.5mm  15mm 	19mm 	19mm 	Dependant on thickness. See Knauf Insulating Laminates brochure.	Dependant on thickness. See Knauf Insulating Laminates brochure.	Dependant on thickness. See Knauf Insulating Laminates brochure.
900, 1200	1200	600	600	1200	1200	1200
2400, 2700, 3000	2400, 3000	3000	2400	2400	2400	2400
A, D, F & I	A, D, F, H1, I & R	A, D, F, H1, I & R	A	EN 13950	EN 13950	EN 13950
0.24W/mK	0.24W/mK	0.24W/mK	0.19W/mK	0.038W/mK	0.033W/mK	0.022W/mK
✓				✓1	✓1	✓1
✓				✓1	✓1	✓1
✓	✓			✓1	✓1	✓1
✓	✓		✓			
✓	✓					
✓	✓					
✓	✓					
		✓				
✓	✓					

Specialist plasterboards



Knauf Safeboard – X-ray shielding

Knauf Safeboard is an X-ray resistant plasterboard with barium sulphate in its core. It effectively and significantly reduces the amount of lead needed within X-ray shielding partitions, in many cases removing the need for lead altogether.

Thickness	Width	Length	Weight	Edge Type
12.5mm	625mm	2400mm	17kg/m ²	Round



Knauf Comfortboard – phase change

Knauf Comfortboard is a unique phase change plasterboard designed to regulate interior temperatures. Knauf Comfortboard is impregnated with phase change material, which stores excess heat in the room and then releases it as ambient temperatures drop, therefore maintaining a comfortable temperature.

Thickness	Width	Length	Weight	Edge Type
12.5mm	1250mm	2000mm	11kg/m ²	Tapered



Knauf Thermoboard – cooling and heating

Knauf Thermoboard is purpose designed for use in chilled ceiling applications, and with wall and ceiling heating systems. The low thermal resistance of Knauf Thermoboard allows for improvements of up to 20% in the operating efficiency of cooling and heating systems.

Thickness	Width	Length	Weight	Edge Type
10mm	1250mm	2000mm	10.2kg/m ²	Tapered



Specialist plasterboards



Knauf Silentboard – Elite sound performance

Knauf Silentboard is a revolution in drywall acoustic performance. The unique patented design of Knauf Silentboard allows for drywall partitions which out-perform the sound reduction of traditional plasterboard and solid masonry walls across a wider range of sound frequencies. Knauf Silentboard partitions are ideal for use in cinemas, nightclubs and other applications where exceptionally high sound performance is required.

Thickness	Width	Length	Weight	Edge Type
12.5mm	625mm	2000mm	17.5kg/m ²	Round
12.5mm	625mm	2400mm	17.5kg/m ²	Round
12.5mm	625mm	2500mm	17.5kg/m ²	Round



Knauf Cleaneo Akustik – sound absorption

Knauf Cleaneo Akustik reduces noise reverberation while enhancing the design of any space. Twenty different perforation styles give the specifier complete creative freedom, while the tested and proven sound absorption performance gives complete confidence. All Knauf Cleaneo Akustik boards are supplied with the Cleaneo air-cleaning effect to reduce in-air VOCs and pollutants and, with their high-quality paper face, provide an excellent surface for direct decoration.

Thickness	Width	Length	Weight	Edge Type
12.5mm	1188 – 1200mm	1875 – 2400mm	9.2 – 10.5kg/m ²	Variable





Knauf Fireboard – fire protection

Knauf Fireboard is a fleece-lined plasterboard available in a wide range of thicknesses to provide up to two hours of fire protection in structural steel encasement. Knauf Fireboard is also ideal for use as fillets in deflection head details.

Thickness	Width	Length	Weight	Edge Type
15mm	1200mm	2400mm	12kg/m ²	Square
20mm	1200mm	1800mm	15.8kg/m ²	Square
25mm	1200mm	1800mm	20kg/m ²	Square
30mm	1200mm	1800mm	24kg/m ²	Square



Knauf Aquapanel Interior Cement Board – wet room

Knauf Aquapanel Interior is a tough, impact-resistant glass-fibre-reinforced cement tile backer for use in wet and humid areas.

Thickness	Width	Length	Weight	Edge Type
12.5mm	900mm	1200mm	15kg/m ²	Square
12.5mm	900mm	2400mm	15kg/m ²	Square

KNAUF

A photograph of a modern, white, cubic building with a prominent blue 'KNAUF' logo on its side. The building features a long, narrow window with multiple panes. The structure is partially obscured by dense green trees and bushes in the foreground. The sky is a clear, light blue.

Specialist facade boards



Knauf Weatherliner

Knauf Weatherliner is a cement particle board for use in non-continuous damp areas such as drained and ventilated cavities within an external facade system and where further mechanical fixing is required.

Thickness	Width	Length	Weight	Edge Type
12mm	1200mm	2400mm	15.6kg/m ²	Square
12mm	1200mm	2700mm	15.6kg/m ²	Square



Knauf Windliner

Knauf Windliner, easily identifiable by its terracotta external paper finish, is a specialist gypsum-based sheathing board specifically designed for use in non-continuous damp areas such as ventilated cavities within Knauf ThermaFrame systems.

Thickness	Width	Length	Weight	Edge Type
12.5mm	1200mm	2400mm	10kg/m ²	Square



Knauf ThermaFrame Liner

Knauf ThermaFrame Liner, is a specially developed interior plasterboard for 'through-the-wall' Knauf Thermaframe systems, offering enhanced levels of fire and acoustic performance as well as moisture resistant qualities.

Thickness	Width	Length	Weight	Edge Type
12.5mm	1200mm	2400mm	10kg/m ²	Tapered
12.5mm	1200mm	2700mm	10kg/m ²	Tapered



Knauf Aquapanel Exterior Cement Board

Knauf Aquapanel Exterior is a tough cement board for exterior use with a Portland cement and aggregate core, and a coated glass-fibre mesh embedded in the back and front surfaces. Ends are square cut and edges are reinforced and finished.

Thickness	Width	Length	Weight	Edge Type
12.5mm	900mm	1200mm	16kg/m ²	Square
12.5mm	900mm	2400mm	16kg/m ²	Square



TOMORROW'S FUTURE TODAY

Case Study: New Line Learning Academy

Knauf products transform education in Kent

Innovative products from Knauf – the UK's leading manufacturer of lightweight building materials and systems – are enabling pioneering teaching methods to be used at two schools built in Maidstone, Kent, at a cost of £54 million.

Neither the New Line Learning Academy, at Loose, nor its sister school Cornwallis Academy, at Linton, have conventional classrooms but instead are built around 'learning plazas': open-plan spaces that are a storey-and-a-half high, with a mezzanine floor to accommodate up to 120 pupils. Three Knauf products – Knauf Cleaneo Akustik Perforated Plasterboard, Knauf Soundshield Plus and Knauf Impact Panel – ensure that these vast teaching spaces still meet the strict standards laid down by Building Bulletin 93: Acoustic Design of Schools, despite being more than twice the volume of a conventional classroom.

Ceilings in the learning plazas and stairwells are lined with Knauf Cleaneo Akustik 8/18 Square Perforated Plasterboard, which minimises reverberation in large areas. In addition to its excellent acoustic properties, Knauf Cleaneo Akustik is jointed with the Knauf Uniflott tapeless system, which provides a unique seamless ceiling finish. Knauf Cleaneo Akustik is available in 20 different styles, with white, black or grey backing fleece.

The various types of partition walls in the academies provide 37 to 67 dB(Rw) airborne sound reduction to comply with BB93 and are based on the Knauf Performer range of partitions optimised for educational buildings. In areas of high traffic where walls are vulnerable to bumps and scrapes, Knauf Impact Panel was used while stairwell walls and riser shafts are lined using the Knauf Shaftwall system, with Knauf 'CT' Studs, Knauf Coreboard and Knauf Fire Panel.

The £24 million New Line Learning Academy is designed for 1,050 business, enterprise and vocational studies students aged 11 to 18, while the £30 million Cornwallis Academy, for 1,630 students, focuses on science and languages.

Knauf has developed a range of proven systems that meet the specific design challenges for walls, ceilings and floors set by schools and colleges, which mainly concern the acoustic characteristics, fire performance and durability of materials. Its Project and Specification team is well versed in the design requirements of education projects, and can provide hands-on support and advice throughout on larger projects.





Customer Service

UK Freephone: 0800 521 050
UK Freefax: 0800 521 205
Eire Tel: 01 4620739
Eire Fax: 01 4620745
Email: cservice@knauf.co.uk

Technical Service

UK Tel: 01795 416 259
Eire Tel: 01 4620739
Email: technical@knauf.co.uk

Literature

UK Tel: 08700 613 700
Eire Tel: +44 8700 613 700

Website

www.knauf.co.uk
www.knauf.ie

Knauf
Kemsley Fields Business Park
Sittingbourne
Kent ME9 8SR

Knauf
87 Broomhill Road
Tallaght
Dublin 24

Knauf Factory Locations

Ridham Dock
Sittingbourne
Kent

Queens Road
Immingham
N.E. Lincolnshire



© Copyright Knauf 2014

The information given in this publication is believed to be current and accurate as at the date of publication, but no warranty, express or implied is given. Updates will not be automatically issued.



When you have finished with this document please recycle it



This document is printed on 80% recycled paper