



INSTALLATION MANUAL

1100R | 1200R

Platinum Series



30 Day Technical Support:

Call **01908 317512** and request technical support for aiding your installation.

Replacements Parts: Inside of your warranty period visit:

<https://www.insigniashowers.com>, click support and make a warranty claim.

Spares/Replacements Parts: Outside of your warranty period visit

<https://www.insigniashowers.com/replacement-parts.html>

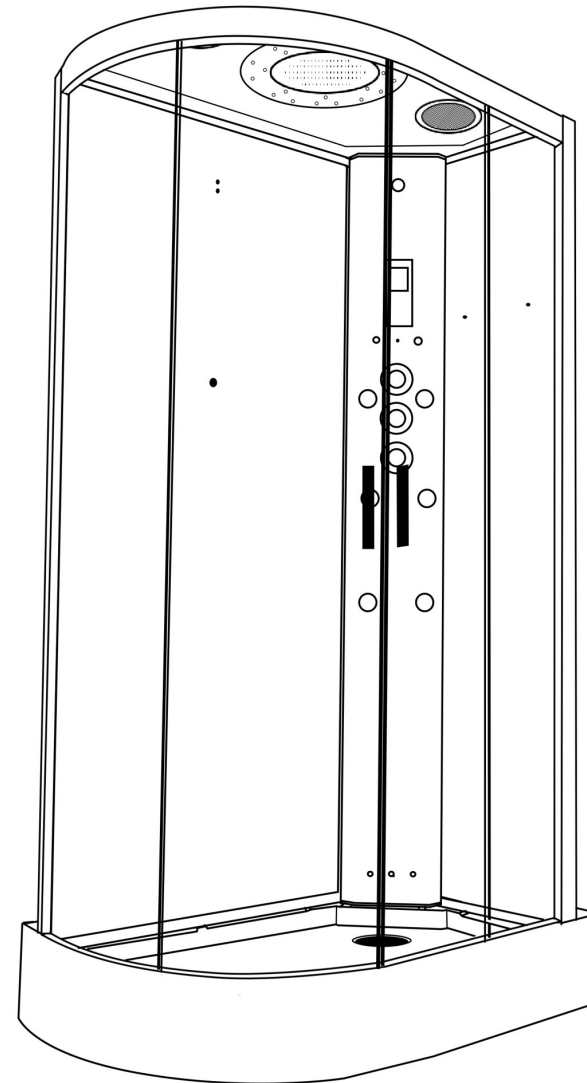

ATTENTION INSTALLERS:

These instructions must be left with the customer

CHECK ALL CONTENTS BEFORE BUILD COMMENCES. NO RETURNS CAN BE MADE ONCE THE BUILD HAS STARTED AS IT IS DEEMED ACCEPTANCE OF PRODUCT!

WARRANTY REG NO: _____

To claim your full 5 year warranty, register your shower within 90 days visit:

<https://www.insigniashowers.com>, click support and register for your warranty

Contents

Installation Assistance (Video Links)	3
Thank you for your purchase	4
Tips for assembly	5
Braided Hose QR Code/Link	6
Electrical/Pressure/Tool requirements	7
Box contents	8
Installing the Waste and Levelling the Tray	9
Connecting the Framework	10
Applying RubberGum	11
Installing the Back Panels	12
Installing the AMI System	13
Installing the Column	14
Installing the Fixed Glass Panels	15
Installing the Glass Seals	16
Installing the Roof	17
Installing the Door Wheels	18
Installing the Accessories	19

Water Valve Connections	20
Control Panel Connections	21
Steam Generator Connections	22
Signing off your shower	23
Control Panel Operating Instructions	24
Spare Parts List	27
Steam Room & Shower Safety Guide	28
Steam Room Usage Guide	29
How to use AMI System	30
Bathroom Electrical Zones	31
WEEE Compliance Statement	33

Installation Assistance

Looking for assistance with the Install?

GREAT NEWS!

We have our easy to follow Installation videos live online NOW to make your installation process easier than ever before!

Simply click the link below and watch the installation process.

[**Shower Install**](#)

Please note: this build video is for a **left** hand shower, however 90% of the process is the same for assembly so it should help you on your way!

*Thank
You*

Thank you for your recent purchase of an Insignia shower. Please read this booklet with great care to ensure you get the best out of your build and have a shower that will last for many years to come! Like everything, in order to obtain a first class product that will serve you well for many years, the effort and correctness put into the assembly will reflect in the quality of your finish.

Before we start, here's our 4 top tips which may assist you...

TIP 1—Building Your Shower

This product is suitable for a DIY build, providing you are confident in your DIY abilities. Please look through this build guide and decide on whether you feel confident in undertaking this task. If you are not, seek the services of a professional and show them these instructions before hiring.

TIP 2—Hard Water

Due to the nature of this product we highly advise the purchase and fitting of a water softener.

(Please note: limescale build up may cause damage to your shower and will not be covered under warranty)

TIP 3—Installation

These showers are designed to be free standing and movable from their location should you have the need to replace anything.

ALWAYS USE Flexible braided water inlet pipes (not supplied) and not central heating plastic type! Get your WRAS Approved Flexible Braided Hoses [here](http://www.insigniashowers.com/wras-approved-braided-hoses.html). (www.insigniashowers.com/wras-approved-braided-hoses.html)

NEVER FIX with rigid pipes, **NEVER FIX** the unit to the wall or floor.

TIP 4—Sealing

When using Insignia's RubberGum, please ensure the product does not come in contact with your silicone as this will cause the RubberGum to fail and will not adhere as intended. RubberGum is immediately waterproof and will gain additional strength over time.

Have you got yours?

Essential for your shower build!

The Insignia **WRAS** approved flexible braided shower hose is an essential part of your shower build. Designed specifically for connecting the hot and cold water feeds allowing for an easier installation. **Note: These are not available in shops.**

Don't worry if you have forgotten to purchase this as we've included this handy link for you! All you need to do is use your smart device and simply point your camera at the QR code to scan it. You can also download a free QR reader app.



Not got a smart device? No problem! Just type the following web link into your web browser:

www.insigniashowers.com/wras-approved-braided-hoses.html



Essential
Item

Electrical Requirements

STEAM VERSION

Voltage Rating 220-240AC

Frequency Rating 50Hz

Power Rating 3KW

NON-STEAM VERSION

Voltage Rating 100-240AC

Frequency Rating 50/60Hz

Power Rating 12v DC/1500 mA

Your electrical contractor should understand **ALL** legal requirements of connection before undertaking any work or installation.

UNDER NO CIRCUMSTANCES UNDERTAKE THIS YOURSELF!!!

Note for electrician: This product comes with 13 amp plug (s) fitted with an RCD unit (*steam version only*). We leave it this way for you to connect it your own way due to continued additions to current regulations.

- 1) Connect within current laws and IP directives.
- 2) (Preferred) Wire into isolated fused feed connecting directly to the house consumer/service box.

Always use protection against electrical surge. Your shower should be treated the same as a home computer. A surge protector should eradicate the possibility of either the transformer or control panel being burnt out. Electrical work needs to be signed off by a fully qualified operative by law. Failure to adhere to this will not only void your electrical warranty for your shower, but could void your house insurance too.

Pressure/Water Requirements

We recommend a BAR pressure between 2.5 and 3.4 BAR. If you have a combi boiler system no problem should be experienced. If you have a gravity feed older type installation (hot water tank type usually less than 1 BAR) you will almost certainly need a pump. We cannot advise on which type of pump is used, location or design because all house plumbing layouts vary. This is a job for your installer/plumber. The end delivery however must fall within the scope above.

Important Note Do not exceed 3.4 BAR pressure under any circumstances. Warranty is void if so as damage will occur. If you have a combi supply, please use a pressure reducing valve if required to lower the BAR pressure to the shower.

Please Remember that this product is free standing and is designed to be pulled away from the wall.

The waste hose must be of a flexible type (**Supplied. Note: Not suitable for solvent type joints**)

The water supply pipes must be that of a flexible braided type (**not supplied**).

DO NOT OVERTIGHTEN THE BRAIDED HOSES AS IT CAN CAUSE THE CONNECTION TO POP AFTER A FEW WEEKS OF USE.

Always fit easy to get to isolation taps on both hot and cold water supply (not supplied). Just like a dishwasher or washing machine, this product **MUST** be isolated when not in use.

Tools Required

You will require:

- | | |
|---|--|
| <ul style="list-style-type: none"> • Scissors • Knife • Spirit Level • Tape Measure | <ul style="list-style-type: none"> • Philips Screwdriver • Electric Drill • Safety Gloves • Safety Glasses |
|---|--|

Parts Required

- RubberGum (supplied)
- Plumbers Mait (not supplied)
- Hot and cold isolation valves (not supplied)
- Suitable McAlpine type 40 mm compression coupling for waste to house connection.
- 2x Braided hoses (not supplied) Steam version requires 3. If you haven't purchased these already, simply click the following link below or copy in to any web browser. For ease we have listed the required pack below for your install.
- Shower cabins require **pack 1**
- Shower cabins with steam require **pack 2**

<https://www.insigniashowers.com/wras-approved-braided-hoses.html>

What's in the Boxes?

Box	Contents	Quantity	✓
Tray	Shower Tray	1	[]
	Waste + Hose	1	[]
	Glass Shelf	1	[]
	Riser Rail for hand shower	1	[]
	Screw Pack	1	[]
	Flexible seal (12mm)	1	[]
	Flexible seal (7mm)	1	[]
Glass Room	Glass Doors	2	[]
	Front Fixed Glass	2	[]
Column	Complete Column	1	[]
	Hand Shower	1	[]
Backwalls	Left Back Panel	1	[]
	Right Back Panel	1	[]

Framework	Top Rail	1	[]
	Bottom Rail	1	[]
	Outer Fixed Uprights	2	[]
	Magnetic door seals	2	[]
	Rear flap door seals	2	[]
	Framework Securing Clips	4	[]
Roof	Roof with fittings	1	[]

Screw Pack Contents

Product Code	Description	Quantity
SP097	Door Handles	2
SP276	Twin Door Wheels Non-Push	4
SP276A	Twin Door Wheels Push button	4
SP072	Door stops	8
ST10	10mm Screws	8
ST16	16mm Screws	28
ST20 or WN20	20mm Nut and Bolt or Wing Nut	12
PRC20	Glass Retaining Clips	4
AMI01	Jubilee Clip (For steam version only)	1
SW9	Small Washers	20
DB9	Drill Piece	1

VERY IMPORTANT

Have you got everything? If not please contact the Insignia directly on **01908 317 512**. Remember **NEVER** book your tradesman until everything has arrived, been checked and is present. No replacement/missing parts can be obtained free of charge during or after the build. Any claims can only be within the timescale permitted (48 hours after delivery) and always **BEFORE** build.

Step 1 — Level the Tray and connecting the waste

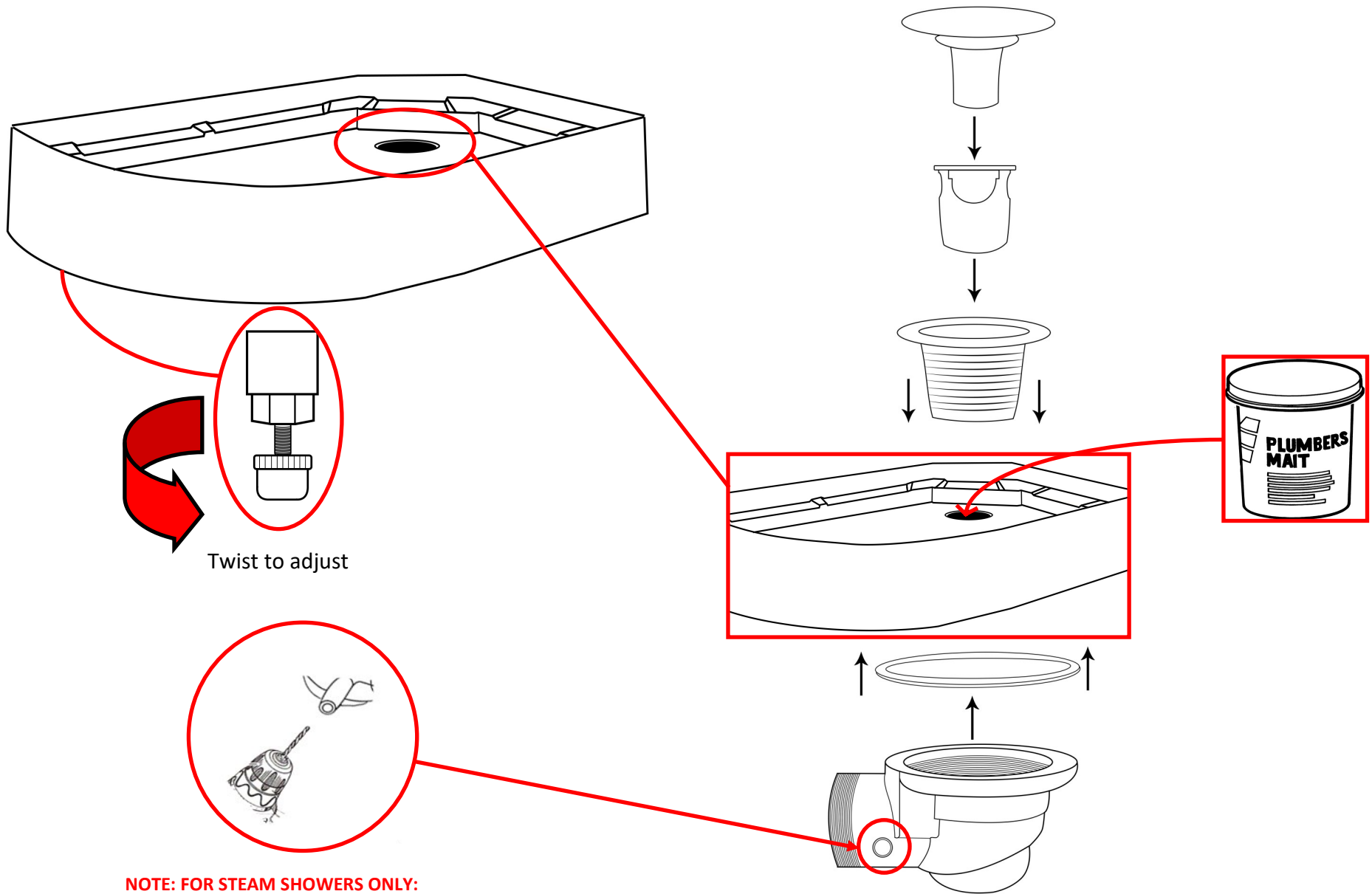

Twist to adjust

NOTE: FOR STEAM SHOWERS ONLY:

Check the Spigot is drilled out prior to fitting. If it isn't ensure you drill it out!

Step 2 — Connecting framework

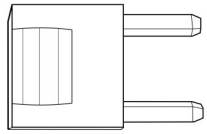

Framework securing clips x4

Wider rail on top

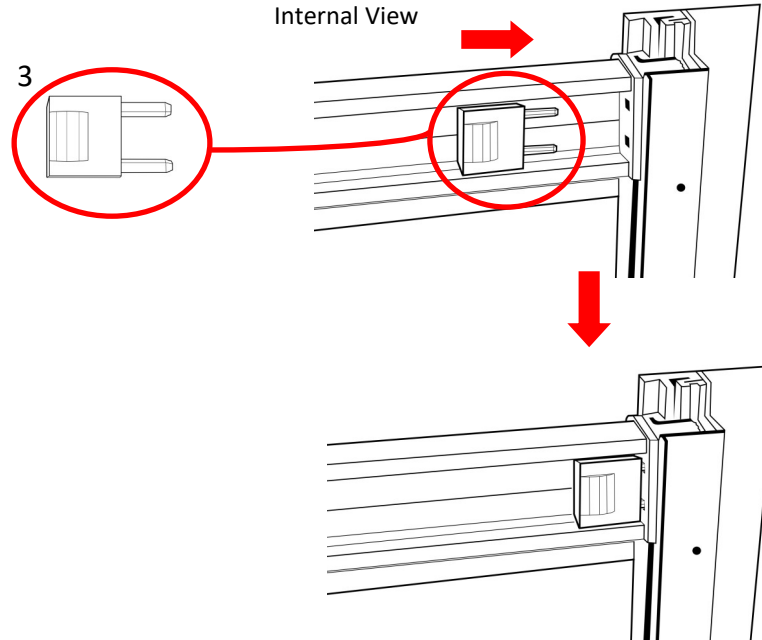
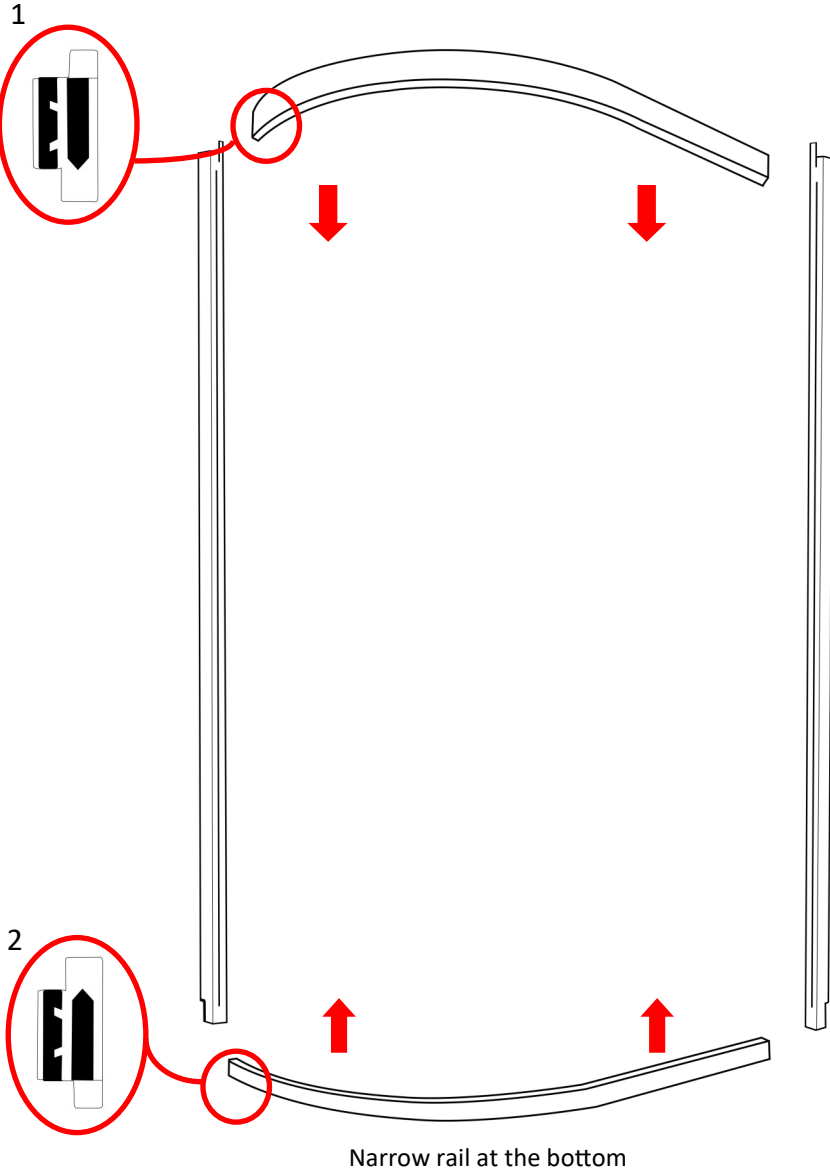

Step 3 — RubberGum the tray

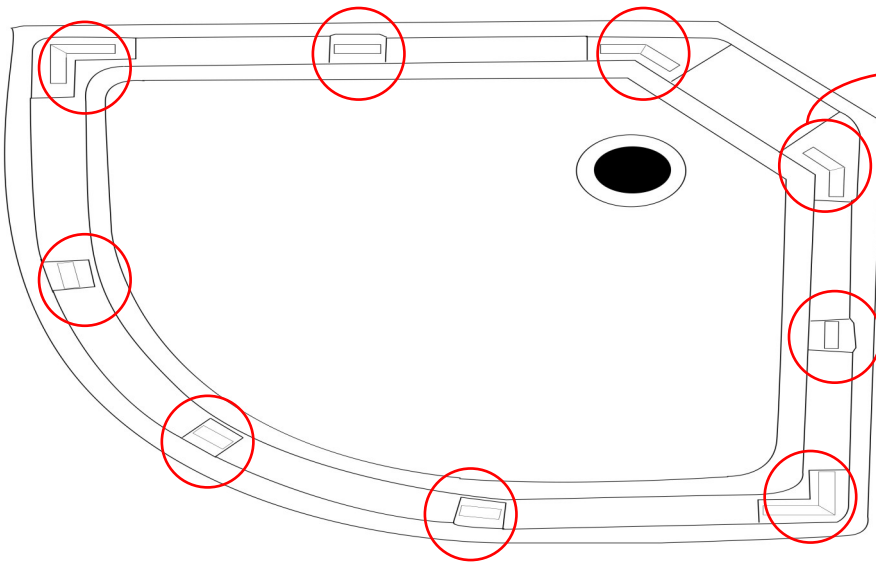

Apply RubberGum to raised sections of the tray and remove backing paper.

A photograph of the product packaging for 'Indignica RubberGum Rubber Adhesive Fung Seal'. The box is black and white with the brand name 'Indignica' in a stylized font. Next to the box is a roll of white adhesive tape with a gold-colored backing paper.

Step 4 — Fix framework to the tray

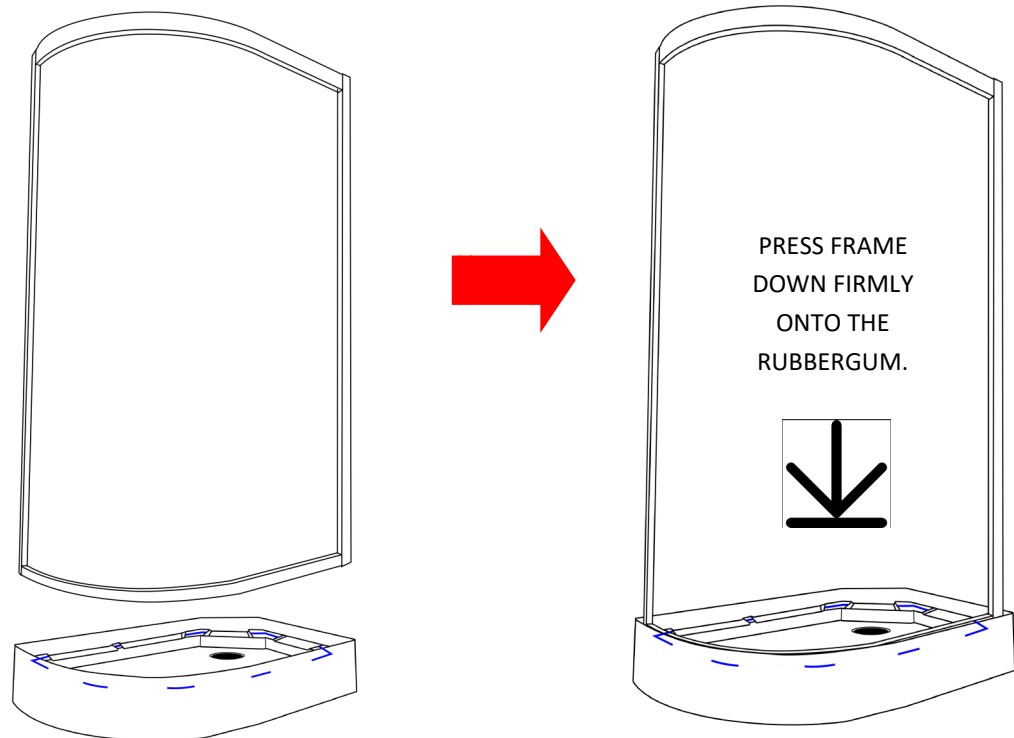

Please Note 2nd Generation showers lower profile curve is not designed to fully follow the tray curve. Gap to tray being wider at each end.

Step 5 — Connecting the back panels

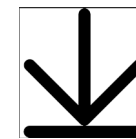
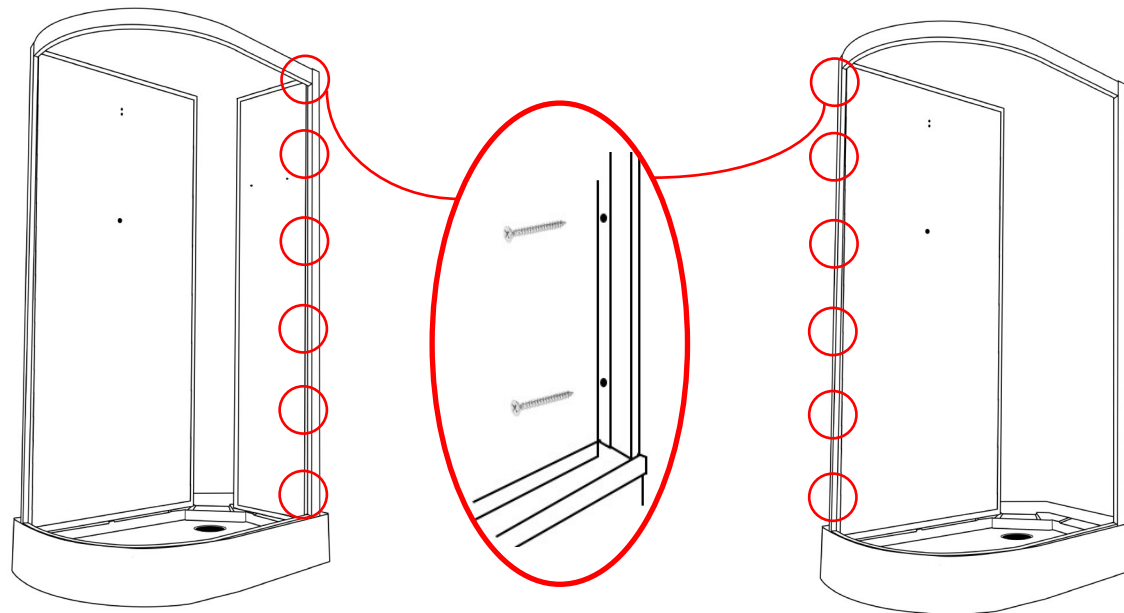

PRESS PANELS
DOWN FIRMLY
ON TO THE
RUBBERGUM.



DO NOT SCREW BACK PANELS TO THE TRAY.

Step 6 — Column Connection

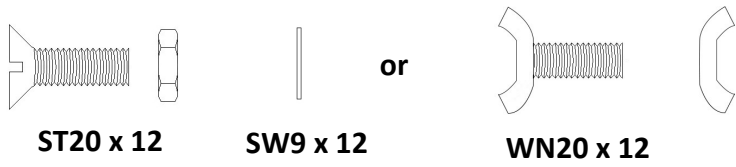

Rear View (attach nuts and bolts or wing nuts from rear)

Below diagram shows the nut/bolt install

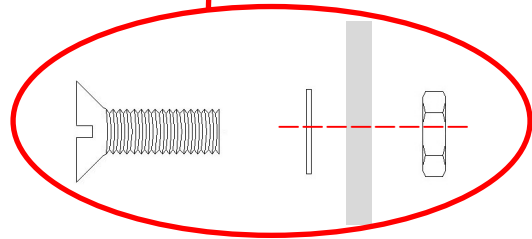
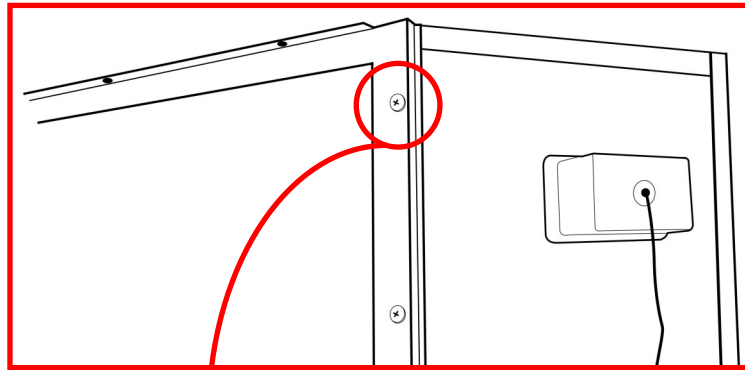

or

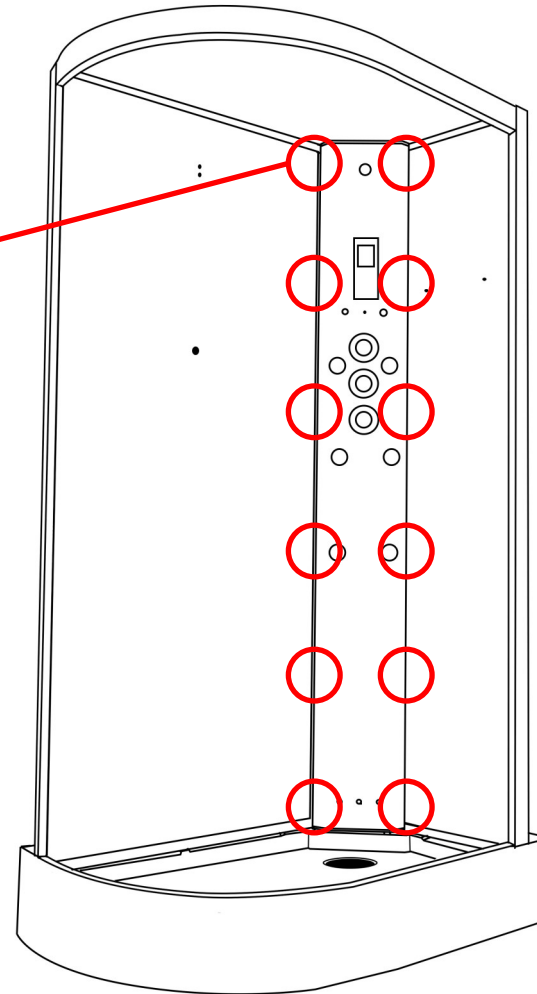
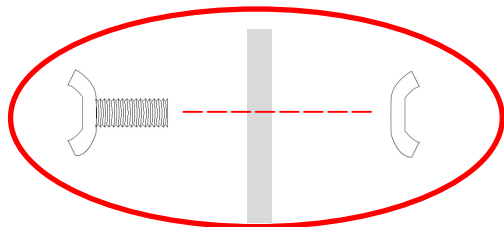

NOTE: Column features varies between models

Step 7 — Fixed Glass Connection

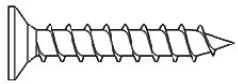

ST16 x 4



PRC20 x 4

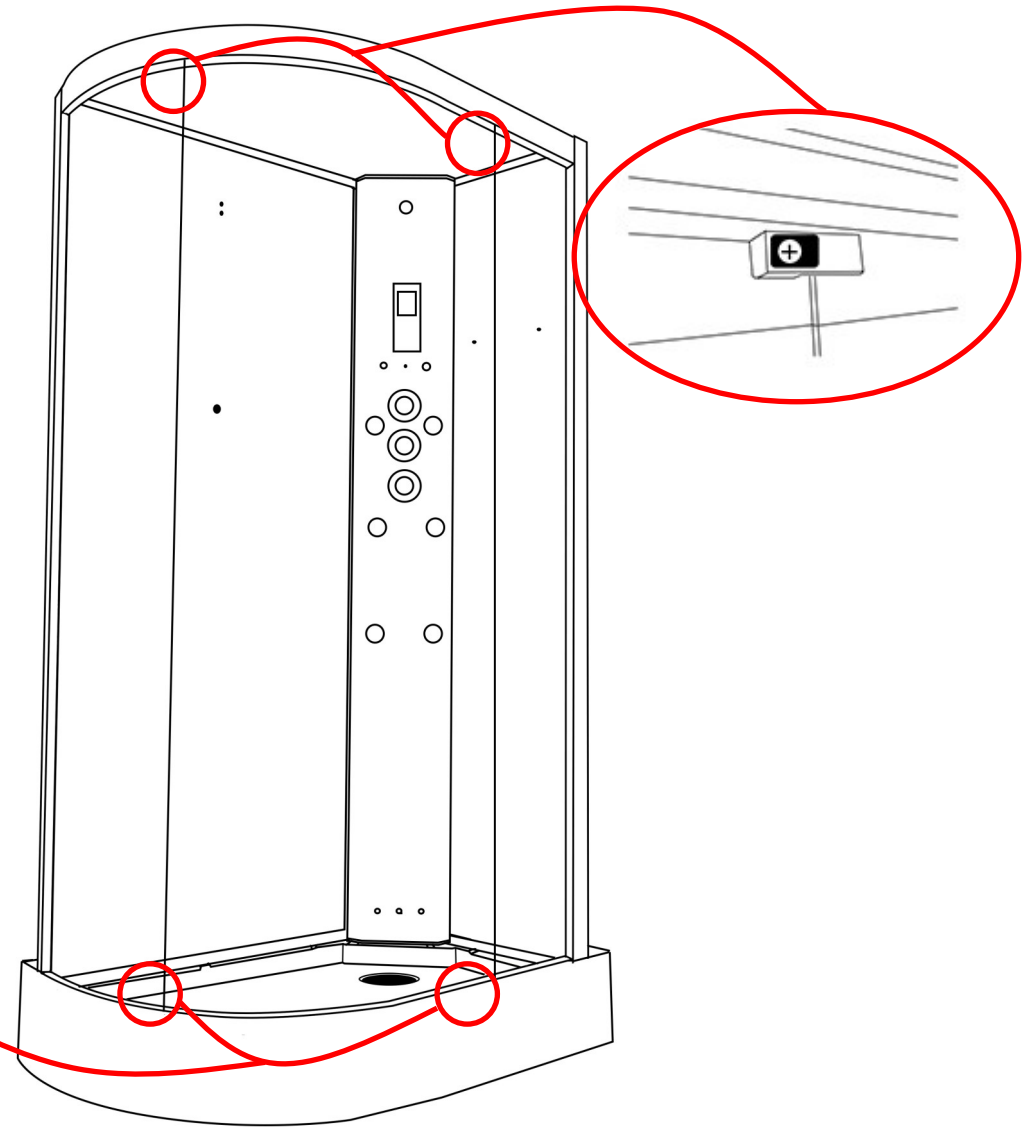
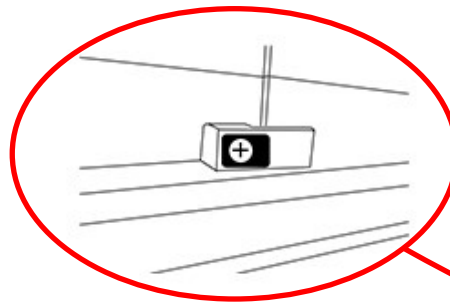
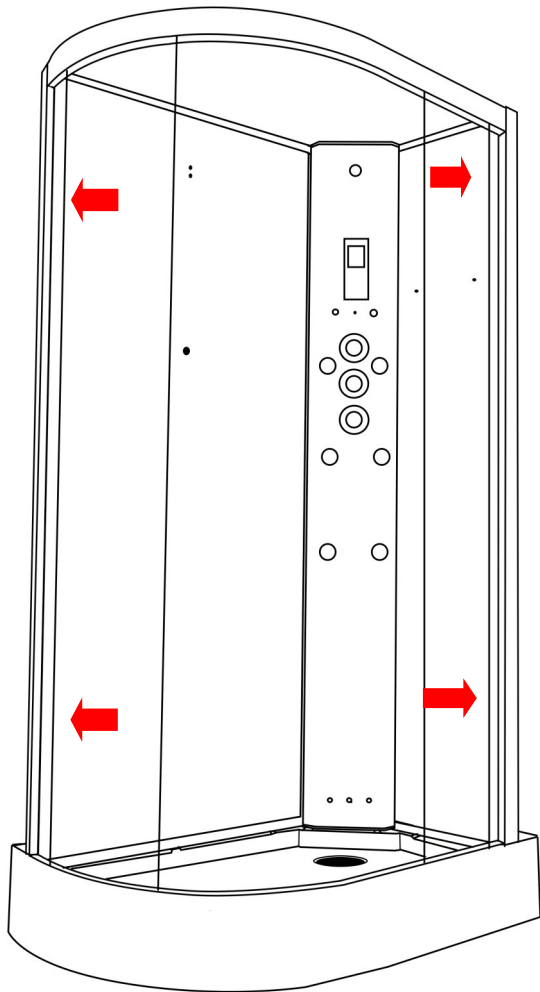

Step 8 — Fitting the glass seals

Fit seal inside the shower between the glass and framework

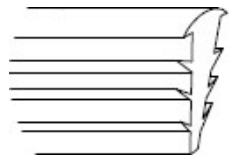

1x 12mm Seal

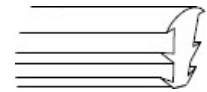

1x 7mm Seal

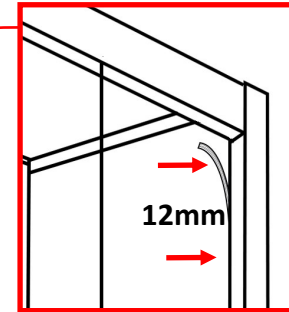
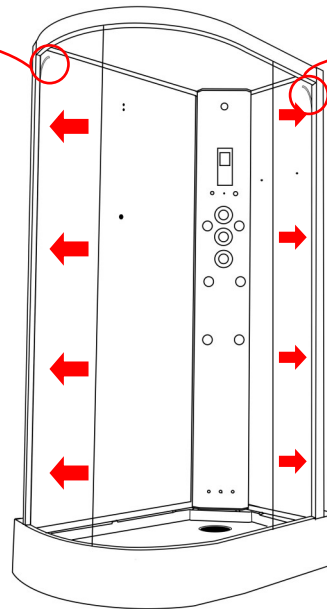
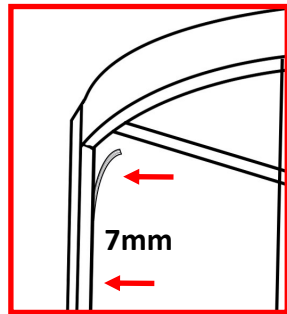

Step 9 — Fitting the door stops

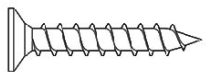

ST10 x8



SP072 x8

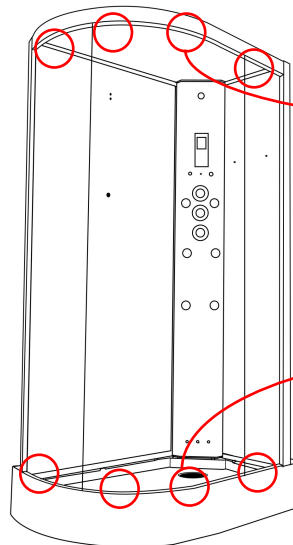

Internal View — Top Rail

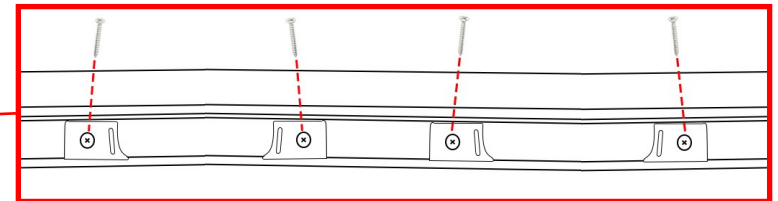
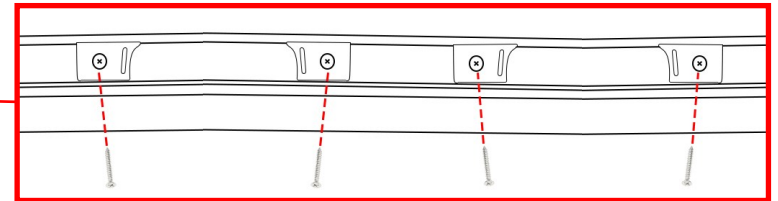

Internal View — Bottom Rail

Step 110— Attaching the Roof

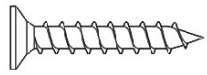

ST16 x6

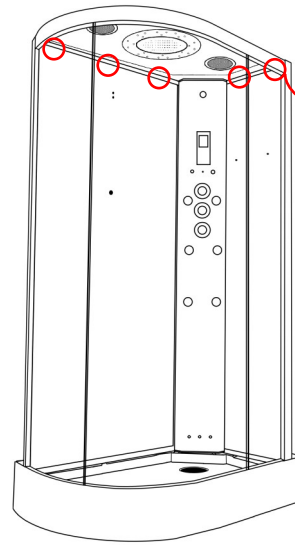
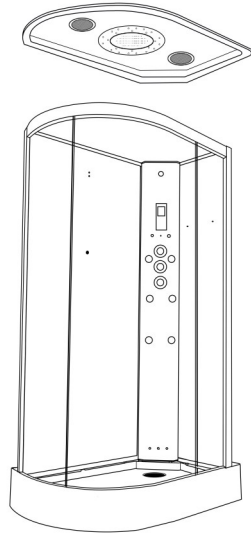

Screw from the rear

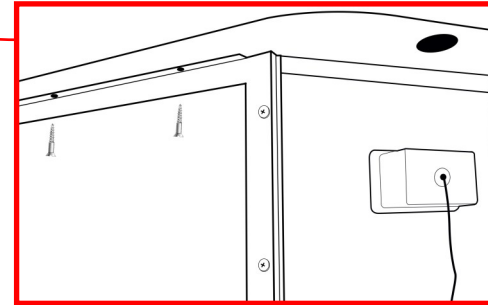

Step 11 — Fit door handles, seals and magnets

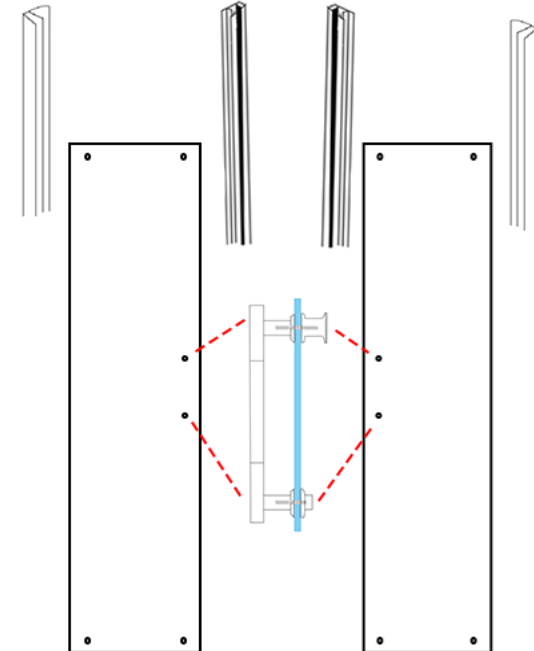
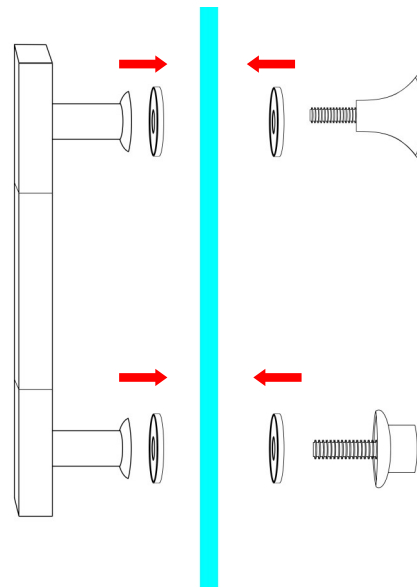

Step 12 — Fit top door wheels x 4

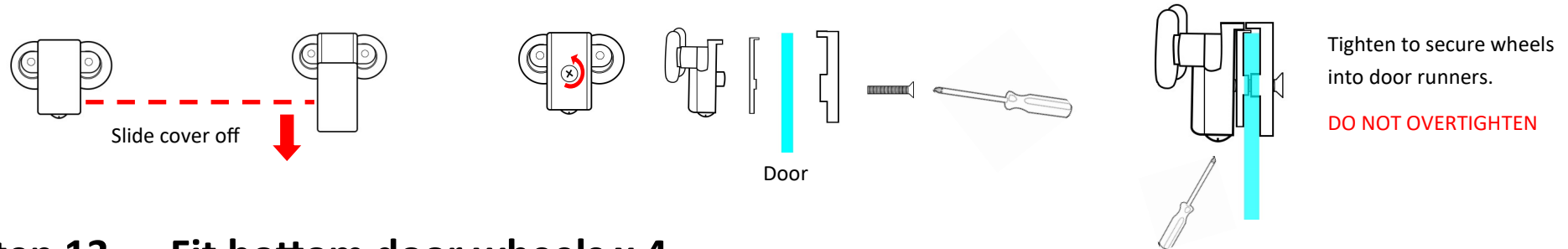

Step 13 — Fit bottom door wheels x 4

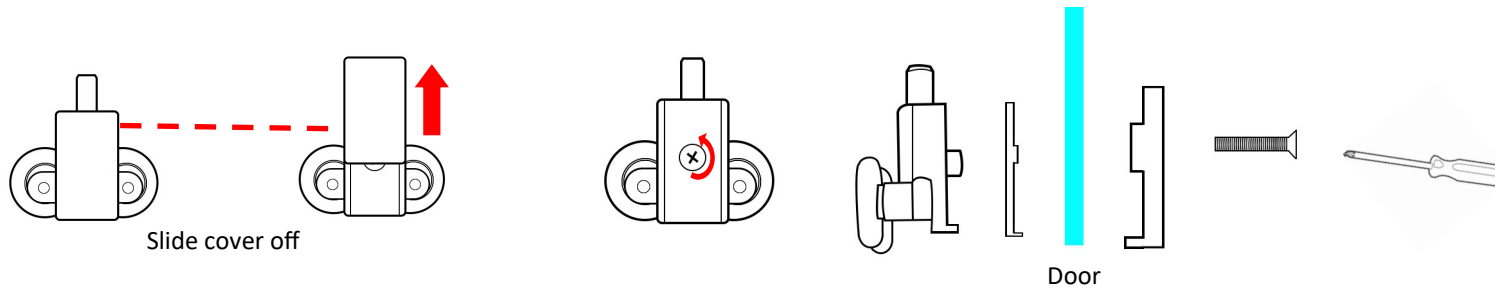

Step 14 — Fitting the doors

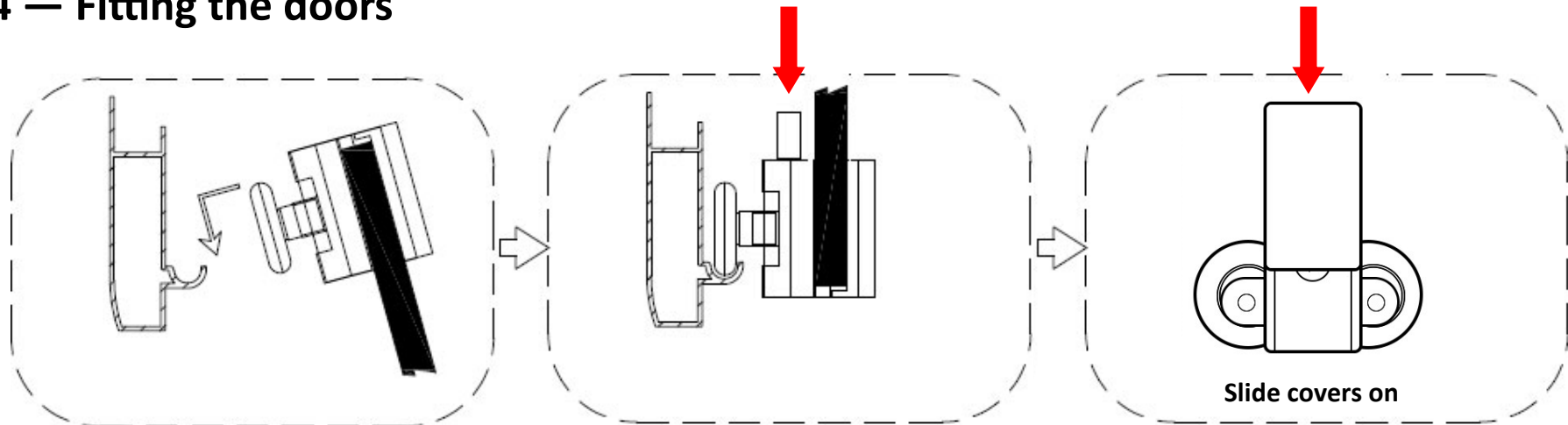

Step 15 — Accessory Installation

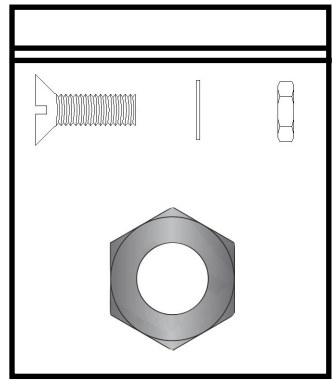

Slide cover off

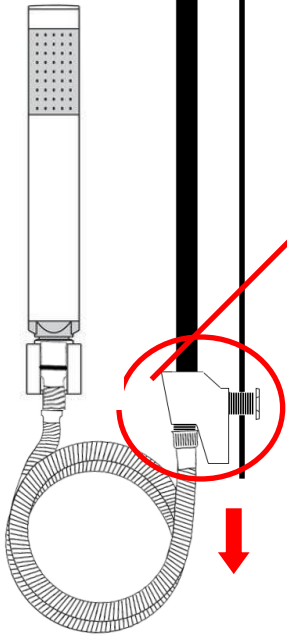
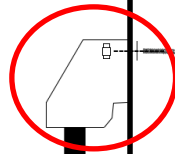

Slide cover off

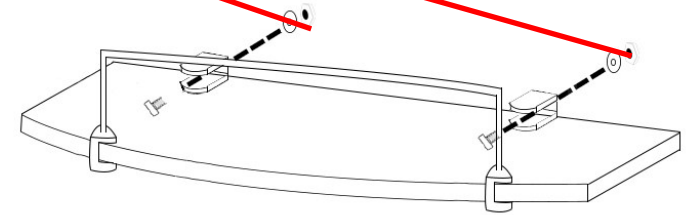
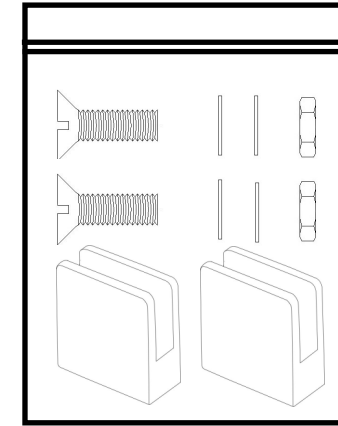

Step 16—AMI Install—Please note: If supplied with this version, it may already be fitted. If it is, please skip this step.

Place in middle hole first

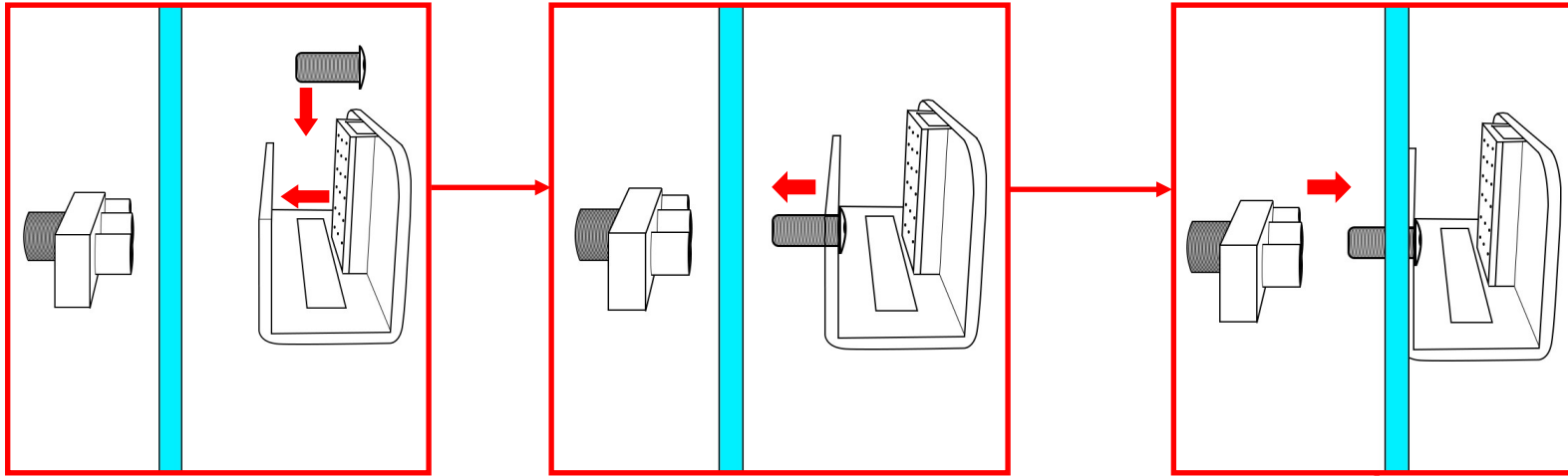

Turn Tri-Jet to tighten

Use Allen key to tighten left chrome outlet

Use Allen key to tighten right chrome outlet

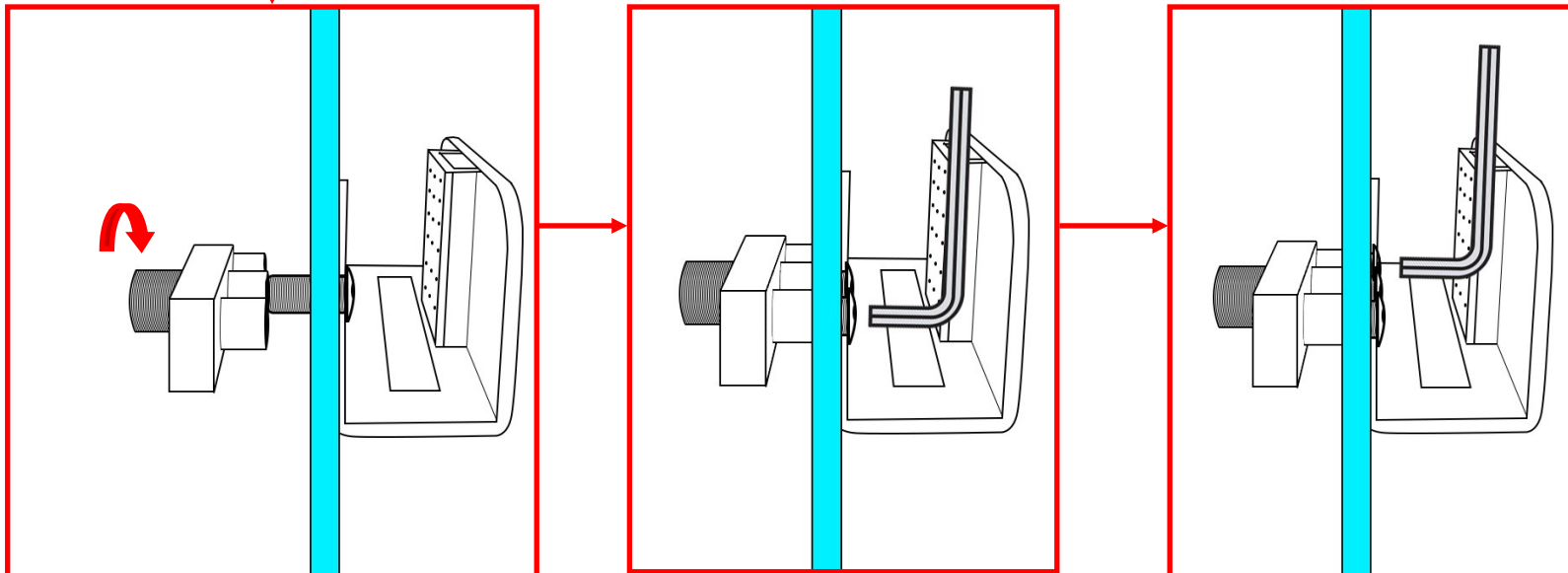

Note:

Connect the 1 metre insulated hose to the back of the Tri-Jet outlet to the 'steam out' on the generator.

Step 17 — Valve/Water Connections

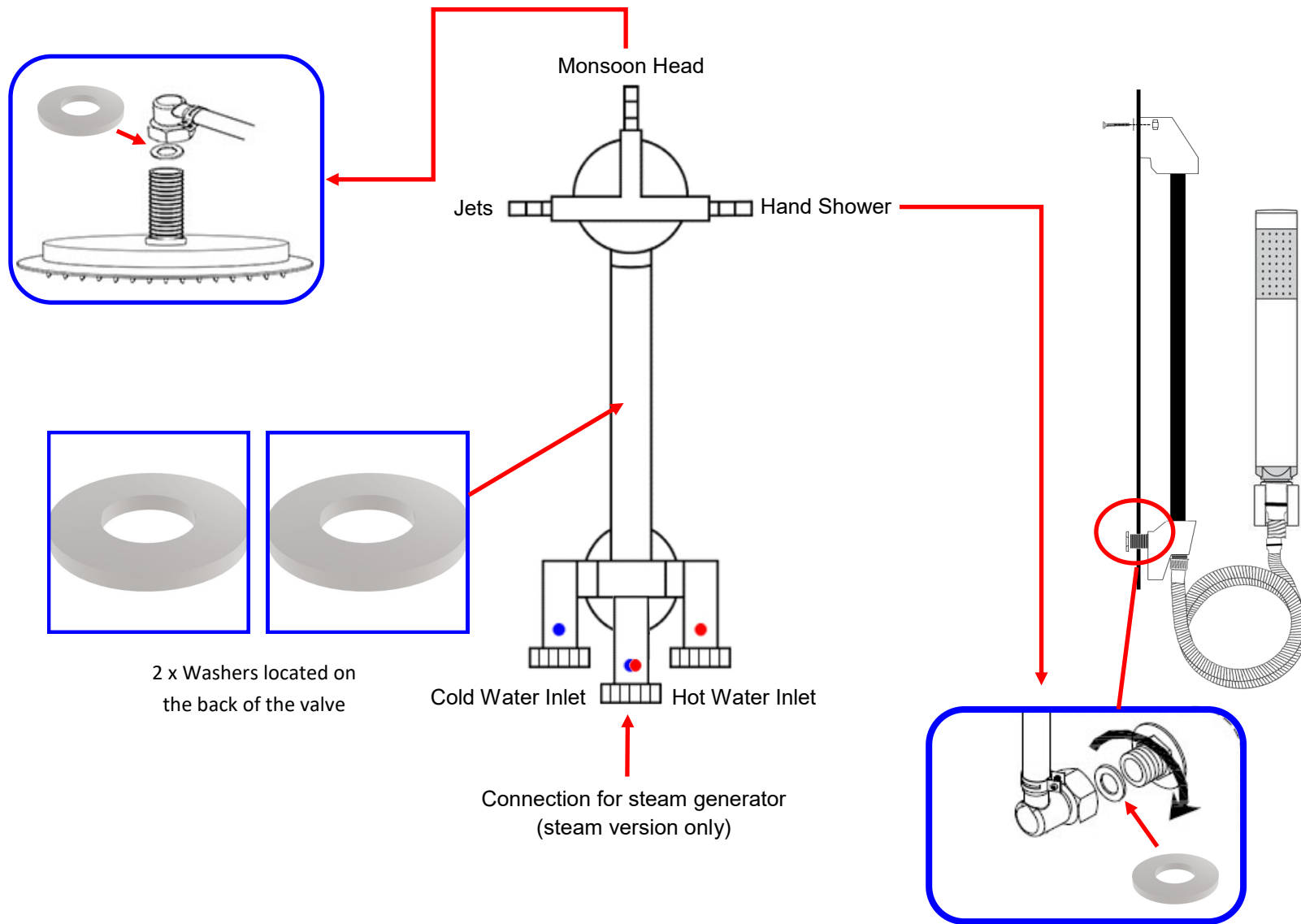

2 x Washers located on the back of the valve

Cold Water Inlet Hot Water Inlet

Connection for steam generator (steam version only)

Step 18 — Control Panel Connections

Platinum Steam Version

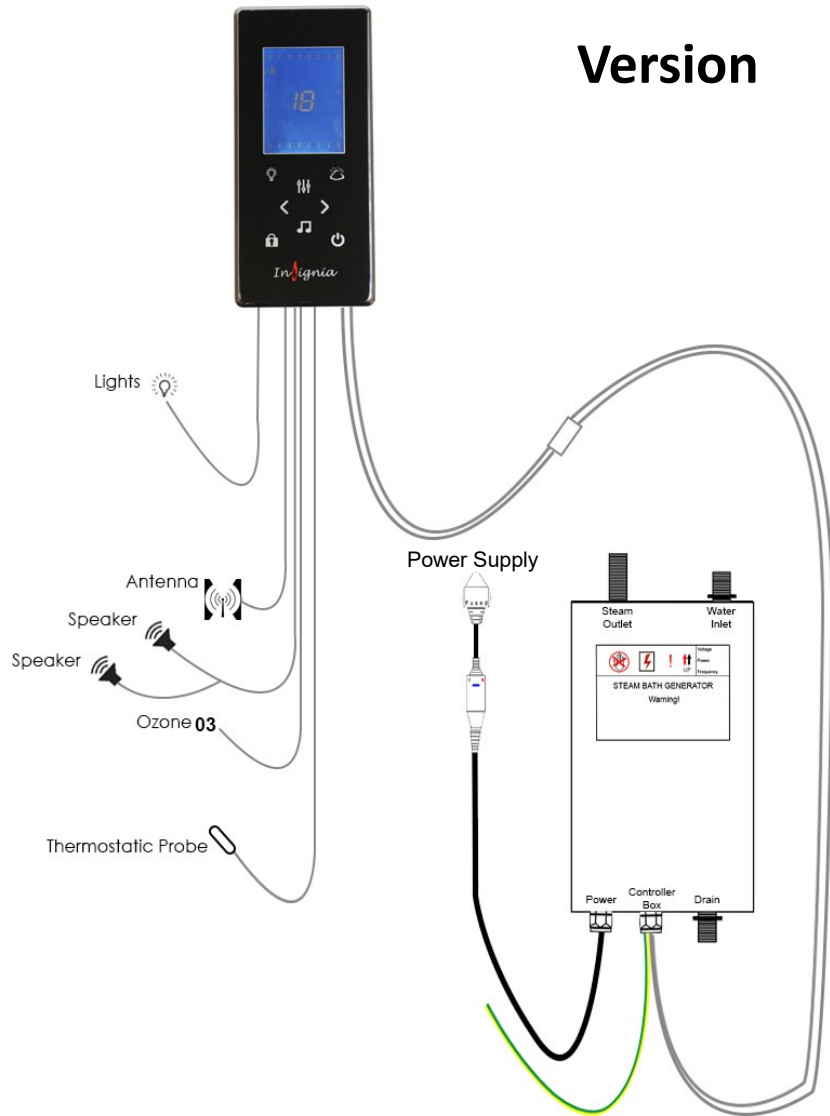

Platinum Version

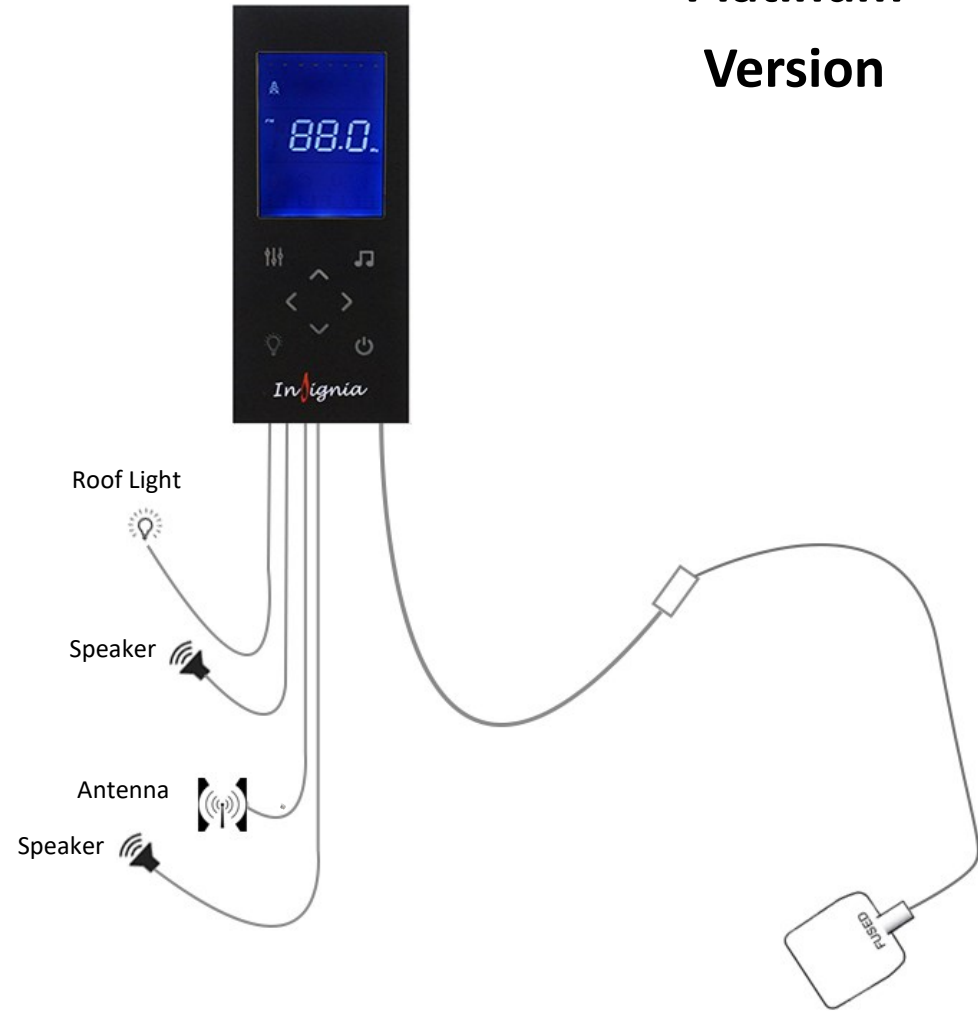

Steam Generator Connections (steam version only)

The steam generator has 3 connections.

1. **Steam Outlet:** Connect the white insulated hose to the steam system within your shower as shown in image A. Make sure these are fitted in the correct position as they are only attached for transportation reasons only.
2. **Water Inlet:** When installing the water line for the steam generator, there are 2 options available:
 - Purchase Insignia’s WRAS approved braided hoses—different packs are available for different shower types.
 - Install a static water line from the shower valve (middle feed) to the steam generator. Even with a static water line, flexible hosing will still be required for the hot and cold water feeds. If you choose this option, please ensure you purchase the correct hose pack from www.insigniashowers.com
3. **Drain:** Connect the grey rubber hose from the steam generators drain opening to the nozzle on the shower waste as shown in image B. Secure in place with the use of the Jubilee clip (AMI01) found in your screw pack Ensure you drill out the spigot to allow the steam generator water to drain in to the waste.

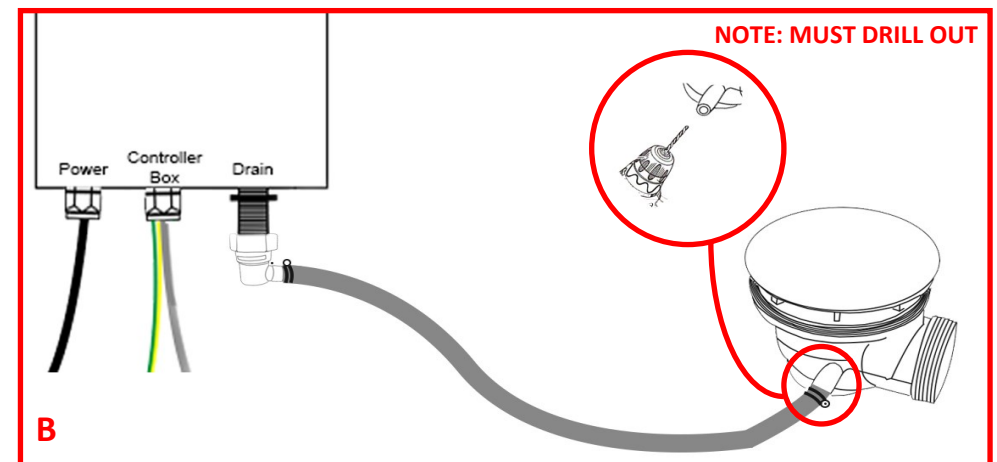
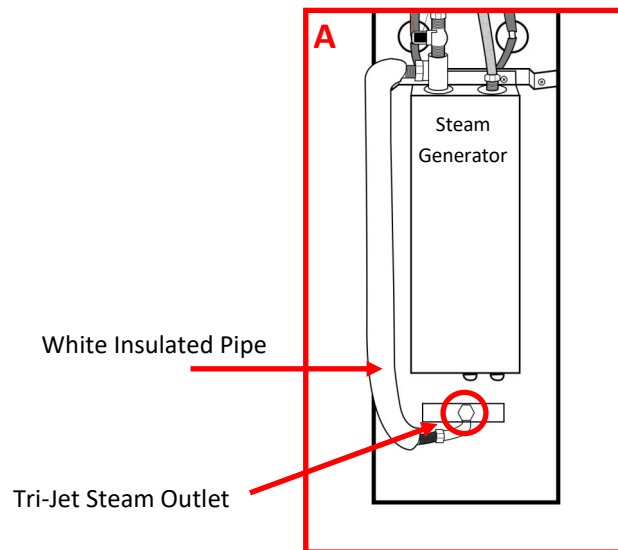
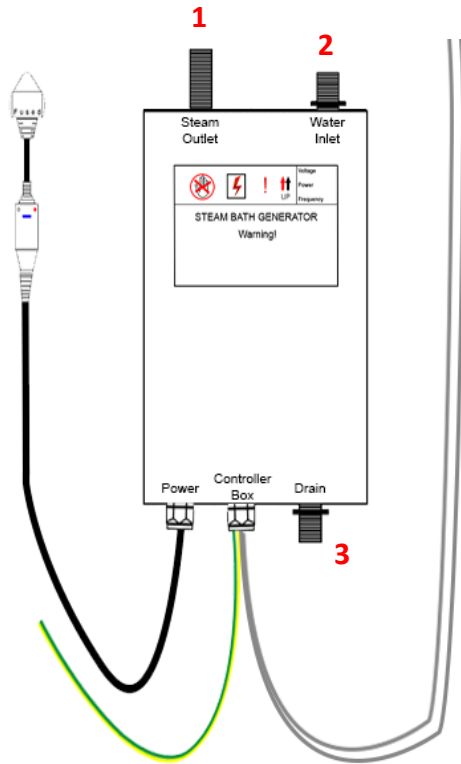

Signing off your shower

Now your shower is assembled, there is just few steps before you can sign the shower off.

1. Please ensure ALL the connections are watertight including waste, pre-fitted body jets as clips are only lightly tightened in place for transit and can be dislodged, internal and external hoses and steam connections (model dependent)
2. Once you are happy, check the shower functions by switching on the overhead shower and then adjust the selector knob (top knob) to the hand shower and then onto the body jets. Whilst the water is running, check external hoses for any signs or water drips or leaks and tighten accordingly.

Please note, when testing the body jets, water will shoot towards the open doors and the user.

3. Do not aim the hand shower directly at the joints of your shower as this does not fall under “normal showering conditions”. However, due to Insignia’s unique design of the shower tray, water will only leak back in to the tray so you won’t get flooded.
4. Visually check the water flow in to the waste and adjust the feet of the tray accordingly to ensure the direction of the water flows towards to the waste to prevent over puddling (a small amount of puddling is normal).
5. Never use the shower until all checks have been made and the installer is 100% happy in the knowledge no hose leaks are present.
6. Any RubberGum which has squeezed out between the panels and the tray, simply cut off using a sharp, clean knife blade.
7. Now push the shower from it’s base into it’s final position. **NEVER PUSH THE GLASS OR FRAME** into its final resting position.

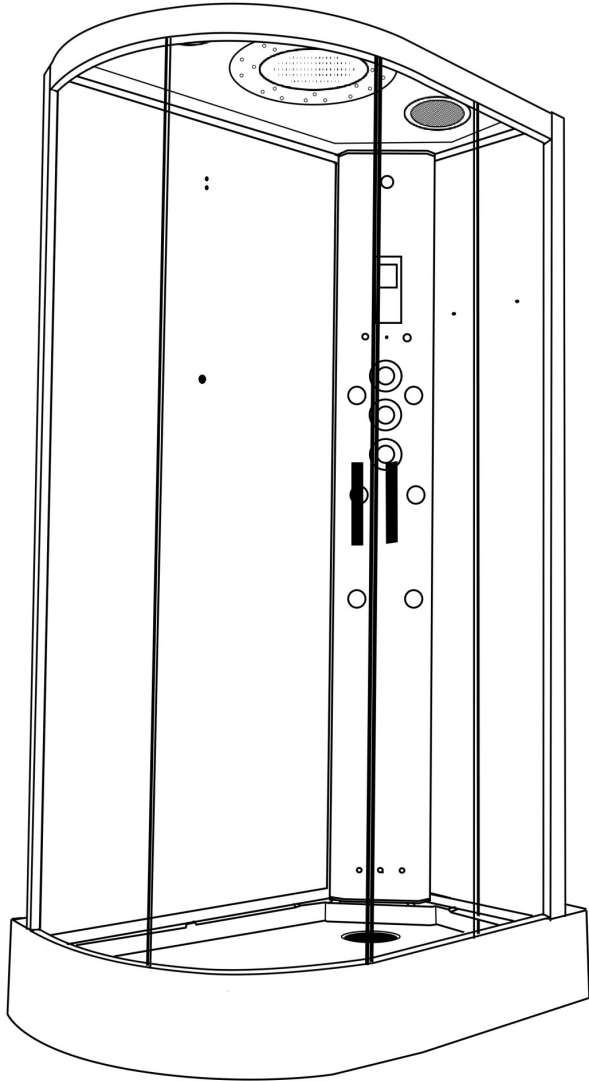

Happy Showering!

Control Panel Instructions (steam version only)



Button 1 (Lights)

Once the control panel is switched on, the lights will come on automatically. Press the Light button once and the lights will start to scroll through the multiple colour options. Then to stop the lights on a specific colour simply press the light button again on the desired colour. To turn the lights off press the light button again.

Button 2 (Steam)

To start the steam function, simply press the steam button (which looks like a cloud). To set the time and temperature of the steam session, simply press the mode button (button 3) and then use the arrows to scroll up and down (button 6)

Button 3 (Mode)

This will do nothing on start-up, however it will be your go to button when using steam, radio and Bluetooth options

Button 4 (Padlock)

This is your unlock button. After twenty seconds of inactivity the steam function will lock on the panel. This is done as a safety feature, so it can't be accidentally activated. Other buttons will remain functional whilst in this state of 'lock mode'

Button 5 (Music)

Press once for FM Radio and press twice for Bluetooth. For tuning radio stations or connecting Bluetooth, please see the next page. For volume control, once on the radio or Bluetooth setting press Mode (button 3) then use the left and right arrows to change the volume. The volume is denoted by a number followed by the letters 'db'

Button 6 (Left and Right Arrows)

This will do nothing on start-up, however they are multi-functional depending on what setting you are using. When in the radio setting you can use them to change the station. When using the Bluetooth setting you can skip forward or back tracks in your playlist. You can also control the volume with these arrows as directed above.

Button 7 (Power)

Press once to turn on the panel. Simply press again to turn it off. When powering down the O3 will automatically start and last for approximately 10 minutes. After this the screen will power off.

To see our tutorial videos for operating Insignia control panel's, please search for "Insignia Showers" on YouTube and find our "Insignia Control Panel" Playlist, or you can [click here](#)

Control Panel Instructions

Connecting to Bluetooth



Step 1

To connect a device via Bluetooth, press the music function button twice (which looks like a musical note) the control panel will then show "INS".

Step 2

Then simply go on your device and pair up with the shower which should be shown as "INS". Once this is complete you will hear a beep to signify you're connected and ready to listen to any music of your choice.

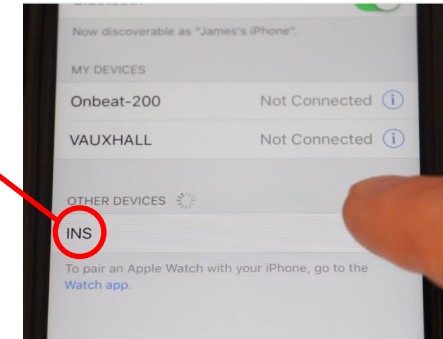

Tuning your radio channels



Step 1

To tune your radio channels firstly press the music function button (which looks like a musical note)



Step 2

Then once the radio is on press and hold the mode button until it starts scrolling.



Step 3

Finally, once the panel has finished scrolling then use the left and right arrows to cycle through all the radio stations that were found.

Control Panel Instructions (non-steam version only)



Button 1 (Radio Search)

With the Radio function active, press to allow manual searching of a station.

Button 2 (Mode)

Press x1 to turn on the radio (whilst active press and hold to do an auto search for stations)

Press x2 to activate the Bluetooth

Button 3/7 (Audio Volume)

Press up or down to increase or decrease the volume in the cabin. Also use this when manually searching for a radio station.

Button 4/5 (Skip button)

Press to skip radio station on the radio setting. When the Bluetooth is activated this will skip to the next song in your playlist.

Button 6 (Lights)

Press to activate or deactivate the lights.

Button 8 (Power Button)

On/Off.

To see our tutorial videos for operating Insignia control panel's, please search for "Insignia Showers" on YouTube and find our "Insignia Control Panel" Playlist, or you can [click here](#)

Parts List

Part Code	Part Description
SP333	Monsoon Shower head
SP078	Ozone Module (steam version only)
SP174	Round Body Jet (Two Open Ends)
SP174a	Round Body Jet (One Open End)
SP236	Complete riser bar
SP112 (warranty)	Shower holder (for riser bar)
SP120 (warranty)	Water Inlet (bottom part of riser bar)
SP142	Shower waste
SP097	Chrome rectangular door handles
SP190	Glass Shelf
SP196	Thermo sensor holder (steam version only)
SP072	Door stoppers
SP276	Twin Door Wheels Non-Push
SP276A	Twin Door Wheels Push Button
SP034	Tri-Jet system (steam version only)
AMI17	Aromatherapy Oil Diffuser (steam version only)
SP105	Chrome Flexible Hose
SP036	Speaker
SP085	Speaker Splitter Cable
SP228	Speaker cover
SP211	12V Transformer (non-steam version only)

SP337	Insignia Control Panel (non-steam version only)
SP117	Insignia Control Panel (steam version only)
SP227	Microphone Style Hand Shower
SP270	Chromotherapy Lighting
SP194	Fixed Glass Seals (12mm)
SP197	Fixed Glass Seals (7mm)
SP407	LeakFree Framework Securing Clip (Black)
SP407B	LeakFree Framework Securing Clip (Chrome)
SP031	Chrome Knob for Thermostatic Dial
SP025	Chrome Knob for Selector/ Water Flow Dial
SP116A	Water Valve Chrome Selection Plate
SP116B	Chrome Water Valve Water Flow Plate
SP116C	Chrome Water Valve Temperature Selection Plate
SP401	PRC20 Glass Securing Clip

SP300	Waste hose
SP301	White insulated pipe (steam version only)
SP187	Drain Hose (steam version only)
SP234	Vertical steam generator/Electric box (steam version only)
SP308	Magnetic door seals
SP310	Rear door seals
SP173	3 port—3 feed thermostatic valve (steam version only)
SP089	3 port—2 feed thermostatic valve (non-steam version only)
SP095	3 Port Selector Cartridge
SP044	On/Off Water Mixer Valve
SP182	Vernet Screw Fit Thermostatic Cartridge
SP043	Plastic Thermostatic Valve Safety Lock Ring
SP321	LeakFree Column End Caps
SP101	UPVC Hose

Steam Room & Shower Safety Guide

1. Never leave children unattended in the shower or bath.
2. Never bath children (under 12) using whirlpool function if fitted.
3. Regulate the temperature of water before showering.
4. Never allow children to use the steam function. This function is for **ADULTS ONLY**.
5. Always be aware of the steam outlet position. Never use in close proximity to the person using it.
6. Exit the steam room immediately if feeling dizzy, faint or short of breath.
7. Do NOT use the steam room if you're pregnant, have a heart condition, have low or high blood pressure. If you're unsure consult your GP before use.
8. If you have any underlying health conditions which you feel could be aggravated by using a steam room, consult your GP before use.
9. If you begin to have any issues with your health after using a steam room, stop immediately and consult your GP regarding your symptoms before continuing to use.
10. Consult your GP before using the steam room if you're on medication at all, especially with drowsy side effects.
11. Never use this shower if you have been drinking alcohol or under the influence of other substances.
12. Never use with more than one person unless the shower is designed for this.
13. This product is not to be used for washing/bathing animals.
14. Always turn power supply off after use.
15. Always turn water supply off after use.
16. Ensure room is well ventilated after a steam session by using your bathroom extraction fan or opening a window.

Steam Room Usage Guide



1. To use the steam room, turn the control panel on. (1)
2. Press the steam button (2) and your generator will be fed with water and the heating element will begin to heat the water to create steam. (You should be seeing steam from your outlet in approximately 60-90 seconds)
3. To set the temperature you want the cabin to reach, press the function button (3) once the steam is active. You will see a small °C to the right of the display. The large number in the middle of the display can be changed by pressing the arrows (4). The maximum temperature you can reach is 60°C . The average temperature in a steam room is usually between approximately 30 to 36°C subject to bathroom ambient air temperature.
4. To set the length you wish the steam to run for, press the function button again (3) then use the arrows (4) to set your desired time. The maximum length that can be set is 60 minutes.
5. Only steam for approximately 10-15 minutes per session at your desired temperature. Due to temperature, your body can overheat, dehydrate and cause light headedness. This is very important for both your health and wellness.
6. Correct Procedure when using steam is SHOWER FIRST this will open your skins pores and your shower cabin will be warm on use. Steaming without showering lowers benefits and not recommended. If you do so NEVER run your steam generation before use to warm the shower, this can cause damage to operating parts, isn't safe practice and will not warm your cabin. NEVER Shower and Steam at the same time.

Before using the steam room, always read the steam room and shower safety guide first.

How to use AMI System (2nd Gen)

Your platinum shower is fitted with the latest **AMI system (Aromatherapy Modular Infusion)** which takes your steam experience to new heights by enjoying fresh, clean, natural fragrance with the AMI Oil Diffuser Steam Guard. Perfectly designed to deliver the maximum amount of aroma in a matter of minutes.

1. In order to use the AMI Oil Diffuser Steam Guard in your steam cabin you must use in conjunction with the AMI Essential Oil Diffuser Kit.
2. Soak the diffuser pad in water until it is fully hydrated. Pour at least 5ml (half a bottle) of the AMI essential oil onto the pad. The more oil you use the more intense the aroma.
3. Fully insert the diffuser pad into the allotted slot of the AMI Oil Diffuser Steam Guard and engage the steam function on your shower/steam room to infuse the essential oil into the steam. **NEVER** place or remove the pad from the diffuser whilst the steam function is running as scolding could occur.
4. After you have finished your aromatherapy steam session, turn the steam function off and discard of used AMI diffuser pad. Never reuse the pad.



To explore our full range of carefully blended oils or purchase more diffuser pads please visit our website: www.insigniashowers.com/aromatherapy

Bathroom Electrical Zones

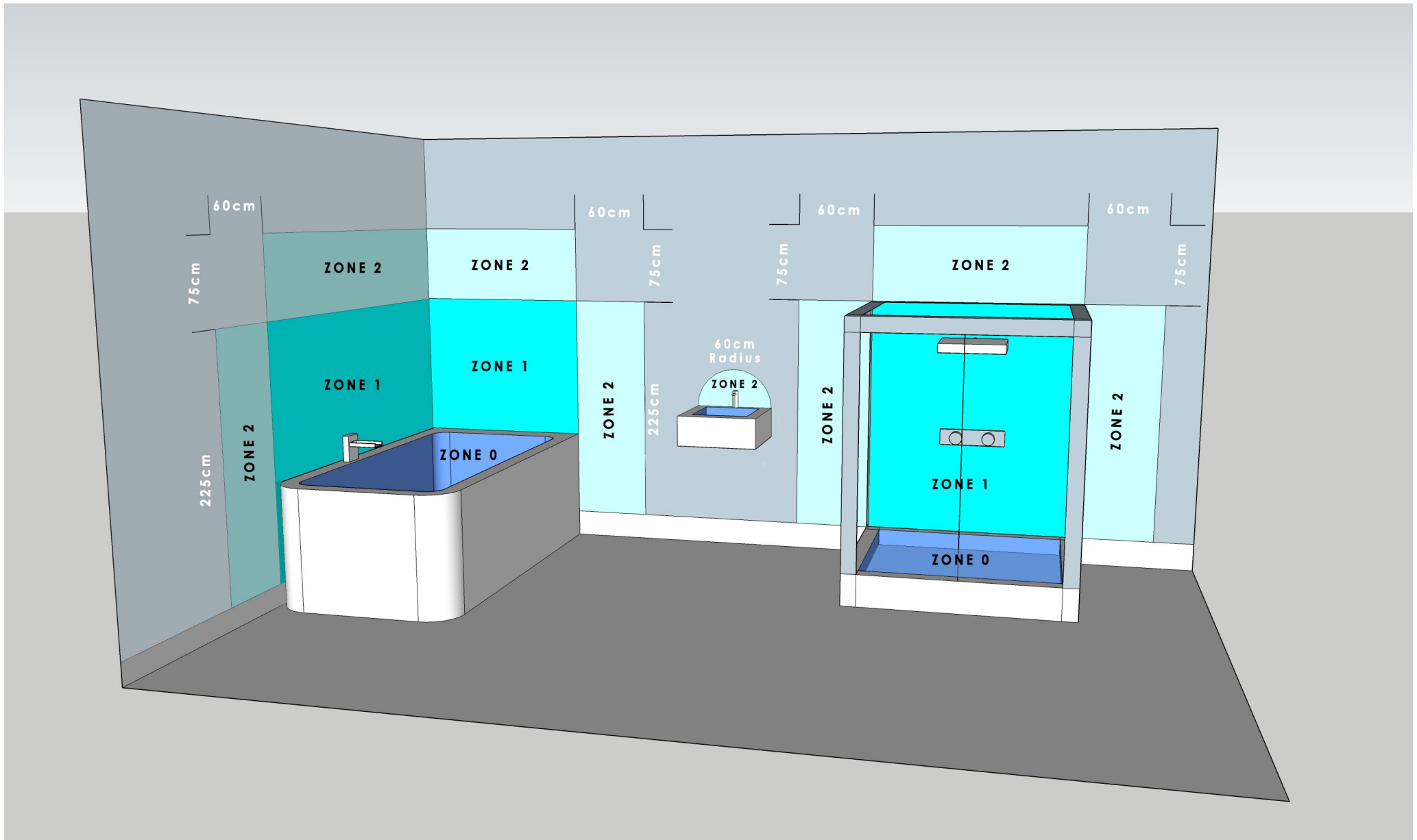

There are 3 bathroom electrical zones that have been distinguished in the IEE wiring guidelines and these are:

Zone 0 is the area inside a bath, basin or shower. It's characterised as 'any area within a bathroom that can hold water'. Any fitting or electrical appliance utilised inside zone 0 must be a maximum of 12 volts (SELV) and completely secured against both partial and total submersion in water (minimum of IPX7)

Zone 1 is the region straight above zone 0 to the height of 2.25m from the base of the bath or shower. It covers the width of the shower cabin or length of the bath. Consider zone 1 to be the 'splash zone', where a fitting or electrical appliance is probably going to get exceptionally wet, very rapidly, however would not be totally immersed in water. Any fitting or electrical appliance inside zone 1 must be IPX4 (splash proof) or have a limit of 12v (SELV) with the transformer situated past zone 2.

Zone 2 is the area extending to 600mm outside of the bath or shower, be that above or to the sides of each. This is commonly the region which is least likely to get wet however there is a likelihood for it to be splashed. Any fitting or appliance inside zone 2 has to be IPX4 (splash proof) or have a maximum of 12v (SELV) with the transformer situated past zone 2.

Outside zones (Beyond Zone 2)

At the point where the size of a bathroom goes past zones 0, 1 and 2, portable electrical appliances can be utilised if their cord length doesn't allow them to be used in zone 2. For example, a hairdryer can be used in the outside zones provided its extended length doesn't enable it to be used in zone 2. Despite the fact that installing electrical appliances past zone 2 is allowed without an IP number, it is recommended that electrical appliances have some type of protection from moisture.

The Ingress Protection or IP number denotes the amount of mechanical and moisture protection an electrical appliance has. The 'IP' notation is followed by 2 numbers that show a numerical degree of mechanical and moisture protection.

The higher the number, the better the assurance it has against moisture/damage. If an appliance does not have an IP number it should never be used in zones 0,1,2 or anywhere that has a wet or damp environment.

All electrical circuits inside a bathroom must be protected by an RCD (residual current device), commonly known as a circuit breaker, not surpassing 30mA. RCD's ascertain when an electric current is not functioning normally and break the flow of the current if necessary, to guarantee that you are safe whilst using it.

Precaution should always be taken when introducing any electric appliance into a bathroom. We always advise using a registered bathroom fitter or electrician.

***The information on this page is for guidance only and you should always refer to the current IEE regulations of a qualified fitter or electrician to guarantee you are aware if the latest regulations and codes of practice.**

WEEE Compliance Statement

The UK Waste Electrical and Electronic Equipment (WEEE) regulations came into force on 2 January 2007. Under this new legislation, producers of electrical and electronic equipment (EEE) have to fulfil certain obligations.

Under the WEEE directive Insignia is considered the producer of certain products we supply and in line with the demands of the legislation we are pleased to offer the opportunity to return these products to us for treatment and recycling.

Insignia products will generally have an identifying mark and the common crossed out wheelie bin label. We accept returns of all products carrying the Insignia brand. All other products are either considered outside the scope of WEEE or Insignia is not technically the producer of these products. Insignia also accepts historic like-for-like WEEE returns. All WEEE returned to Insignia will be recycled in appropriate treatment and recycling centres in accordance with the legislation. If you wish to return any products to us, please send your item(s) to our head office.

Company Contract No. 326457

WEEE Producer No. CBDU64227

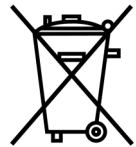

LABELLING

Products labelled with the WEEE symbol (a crossed out “waste bin”) indicate that the final user should not discard this product along with other household waste, but that it must be collected and treated separately.



Returns Address for WEEE

Insignia

9a Deans Road, Old Wolverton, Canon Industrial Park, Milton Keynes, Buckinghamshire, MK12 5NA, UK



EU – Declaration of Performance

Insignia declares that all its products complies with the essential requirements and other relevant provisions of Directive 305/2011/EC. A copy of the Declaration of performance is available from www.insigniarange.co.uk/ce.aspx

Insignia™ is a registered trademark of Maclean International Ltd, 9a Deans Road, Old Wolverton, Canon Industrial Park, Milton Keynes, Buckinghamshire, MK12 5NA, UK

All images are subject to copyright. Images may not be used in any way shape or form with out written permission from Maclean International Ltd. Images are NOT permitted to be saved, printed or uploaded. Violation of copyright laws are punishable by law.

All images are registered with
ImageTraker

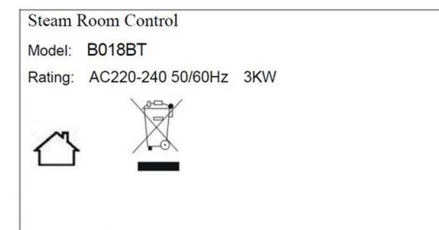
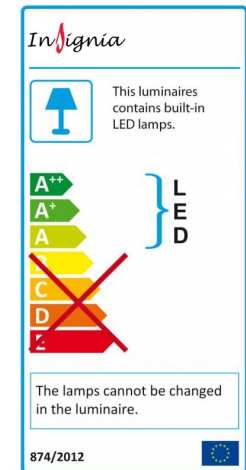

Insignia™ is a registered trademark of Maclean International Ltd

All images are subject to copyright. Images may not be used in any way shape or form with out written permission from Maclean International Ltd. Images are NOT permitted to be saved, printed or uploaded. Violation of copyright laws are punishable by law.